

JVC

PLASMA DISPLAY MONITOR

GD-V502PCE

INSTRUCTIONS

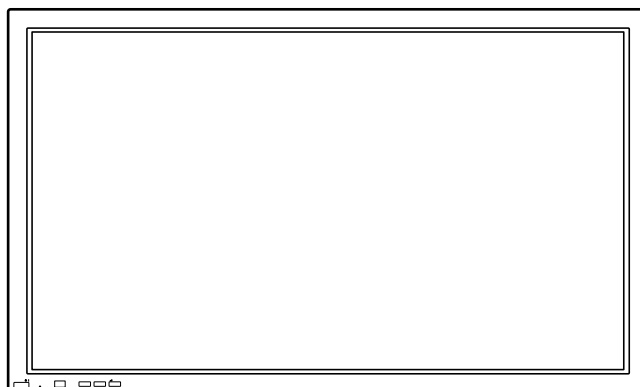

Dear JVC Customer

Welcome to the JVC family of customers. We hope that you will have many years of enjoyment from your new Plasma Display.

To obtain maximum benefit from your set, please read these Instructions before making any adjustments, and retain them for future reference.

Retain your purchase receipt also, and note down the model number and serial number of your set in the space provided on the rear cover of these instructions.

Trademark Credits

- VGA is a trademark of International Business Machines Corporation.
 - Macintosh is a registered trademark of Apple Computer, USA.
 - S-VGA is a registered trademark of the video Electronics Standard Association.
- Even if no special notation has been made of company or product trademarks, these trademarks have been fully respected.

Note:

Do not allow a still picture to be displayed for an extended period, as this can cause a permanent after-image to remain on the Plasma Display.

Examples of still pictures include logos, video games, computer images, teletext and images displayed in 4:3 mode.

Table of Contents

Important Safety Notice	3	PRESENT TIME Setup / Set up TIMER	22
Safety Precautions	4	PRESENT TIME Setup	22
Accessories	6	Set up TIMER	23
Accessories Supply	6	Screensaver (For preventing after-images)	24
Remote Control Batteries	6	Setup of Screensaver Time	25
Connections	7	Reduces screen after-image	25
PC Input Terminals connection	8	Side Panel Adjustment	26
SERIAL Terminals connection	9	Reduces power consumption	27
Basic Controls	10	Customizing the Input labels	27
MULTI PIP	10	Setup for MULTI DISPLAY	28
Power On/Off and input signal selection	12	How to Setup MULTI DISPLAY	28
AC cord connection	12	How to set the display location number for each Plasma Display	29
Power On/Off	12	Setup for Input Signals	30
Select the input signal	13	Component/RGB-in Select	30
Selecting the On-Screen Menu Language	13	3D Y/C Filter – For NTSC AV images	30
On-Screen Menu Displays	14	Colour system / Aspect Auto	31
ASPECT Controls	16	Cinema reality	31
Adjusting Picture Pos./Size	17	Sync	32
Picture Adjustments	18	H-Freq. (kHz)/V-Freq. (Hz)	32
Advanced settings	19	Troubleshooting	33
Sound Adjustment	20	Input signal can be displayed	34
Mute	20	Specifications	35
Digital Zoom	21		

Important Safety Notice

WARNING:

- 1) To prevent damage which may result in fire or shock hazard, do not expose this appliance to rain or moisture.
Do not place containers with water (flower vase, cups, cosmetics, etc.) above the set. (including on shelves above, etc.)
- 2) To prevent electric shock, do not remove cover. No user serviceable parts inside. Refer servicing to qualified service personnel.
- 3) Do not remove the earthing pin on the power plug. This apparatus is equipped with a three pin earthing-type power plug. This plug will only fit an earthing-type power outlet. This is a safety feature. If you are unable to insert the plug into the outlet, contact an electrician.
Do not defeat the purpose of the earthing plug.
- 4) This is a class A product. In a domestic environment this product may cause radio interference in which case you may be required to take adequate measures.

CAUTION

This appliance is intended for use in environments which are relatively free of electromagnetic fields. Using this appliance near sources of strong electromagnetic fields or where electrical noise may overlap with the input signals could cause the picture and sound to wobble or cause interference such as noise to appear. To avoid the possibility of harm to this appliance, keep it away from sources of strong electromagnetic fields.

To prevent electric shock, ensure the grounding pin on the AC cord power plug is securely connected.

FOR UK ONLY

IMPORTANT: THE MOULDED PLUG

FOR YOUR SAFETY, PLEASE READ THE FOLLOWING TEXT CAREFULLY.

This appliance is supplied with a moulded three pin mains plug for your safety and convenience. A 5 amp fuse is fitted in this plug. Shall the fuse need to be replaced, please ensure that the replacement fuse has a rating of 5 amps and that it is approved by ASTA or BSI to BS1362.

Check for the ASTA mark  or the BSI mark  on the body of the fuse.

If the plug contains a removable fuse cover, you must ensure that it is refitted when the fuse is replaced. If you lose the fuse cover the plug must not be used until a replacement cover is obtained.

A replacement fuse cover can be purchased from your local JVC Dealer.

If the fitted moulded plug is unsuitable for the socket outlet in your home, then the fuse shall be removed and the plug cut off and disposed of safely. There is a danger of severe electrical shock if the cut off plug is inserted into any 13 amp socket.

If a new plug is to be fitted, please observe the wiring code as shown below.

If in any doubt, please consult a qualified electrician.

WARNING: — THIS APPARATUS MUST BE EARTHED.

IMPORTANT: — The wires in this mains lead are coloured in accordance with the following code: —

Green-and-Yellow:	Earth
Blue:	Neutral
Brown:	Live

As the colours of the wire in the mains lead of this appliance may not correspond with the coloured markings identifying the terminals in your plug, proceed as follows.

The wire which is coloured GREEN-AND-YELLOW must be connected to the terminal in the plug which is marked with the letter E or by the Earth symbol  or coloured GREEN or GREEN-AND-YELLOW.

The wire which is coloured BLUE must be connected to the terminal in the plug which is marked with the letter N or coloured BLACK.

The wire which is coloured BROWN must be connected to the terminal in the plug which is marked with the letter L or coloured RED.

How to replace the fuse. Open the fuse compartment with a screwdriver and replace the fuse.

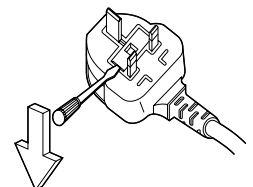

Safety Precautions

WARNING

Setup

This Plasma Display is for use only with the following optional accessories. Use with any other type of optional accessories may cause instability which could result in the possibility of injury.

(All of the following accessories are manufactured by JVC)

- Speakers TS-C5001SPG
- Stand Unit TS-C50P5G
- Video Input Card IF-C50P2G
- Wall Mounting Unit TS-C50P6G
- Wall Mounting Unit (angled) TS-C50P2G
- Ceiling Suspension Unit TS-C50P3G

Always be sure to ask a qualified technician to carry out set-up.

Do not place the Plasma Display on sloped or unstable surfaces.

- The Plasma Display may fall off or tip over.

Do not place any objects on top of the Plasma Display.

- If water is spilled onto the Plasma Display or foreign objects get inside it, a short-circuit may occur which could result in fire or electric shock. If any foreign objects get inside the Plasma Display, please consult your local JVC dealer.

If using the pedestal (optional accessory), leave a space of at least 10 cm at the top, left and right, at least 6 cm at the bottom, and at least 7 cm at the rear. If using some other setting-up method, leave a space of at least 10 cm at the top, bottom, left and right, and at least 1.9 cm at the rear.

Avoid installing this product near electronic equipment that is easy to receive electromagnetic waves.

- It may cause interference in image, sound, etc. In particular, keep video equipment away from this product.

When using the Plasma Display

The Plasma Display is designed to operate on 220 - 240 V AC, 50Hz/60Hz.

Do not cover the ventilation holes.

- Doing so may cause the Plasma Display to overheat, which can cause fire or damage to the Plasma Display.

Do not stick any foreign objects into the Plasma Display.

- Do not insert any metal or flammable objects into the ventilation holes or drop them onto the Plasma Display, as doing so can cause fire or electric shock.

Do not remove the cover or modify it in any way.

- High voltages which can cause severe electric shocks are present inside the Plasma Display. For any inspection, adjustment and repair work, please contact your local JVC dealer.

Securely insert the power cord plug as far as it will go.

- If the plug is not fully inserted, heat may be generated which could cause fire. If the plug is damaged or the wall socket plate is loose, they shall not be used.

Do not handle the power cord plug with wet hands.

- Doing so may cause electric shocks.

Do not do anything that may damage the power cable. When disconnecting the power cable, pull on the plug body, not the cable.

- Do not damage the cable, make any modifications to it, place heavy objects on top of it, heat it, place it near any hot objects, twist it, bend it excessively or pull it. To do so may cause fire and electric shock. If the power cable is damaged, have it repaired at your local JVC dealer.

If the Plasma Display is not going to be used for any prolonged length of time, unplug the power cord plug from the wall outlet.

If problems occur during use

If a problem occurs (such as no picture or no sound), or if smoke or an abnormal odour starts to come out from the Plasma Display, immediately unplug the power cord plug from the wall outlet.

- If you continue to use the Plasma Display in this condition, fire or electric shock could result. After checking that the smoke has stopped, contact your local JVC dealer so that the necessary repairs can be made. Repairing the Plasma Display yourself is extremely dangerous, and shall never be done.

If water or foreign objects get inside the Plasma Display, if the Plasma Display is dropped, or if the cabinet becomes damaged, disconnect the power cord plug immediately.

- A short circuit may occur, which could cause fire. Contact your local JVC dealer for any repairs that need to be made.

CAUTION

When using the Plasma Display

Do not bring your hands, face or objects close to the ventilation holes of the Plasma Display.

- Heated air comes out from the ventilation holes at the top of Plasma Display will be hot. Do not bring your hands or face, or objects which cannot withstand heat, close to this port, otherwise burns or deformation could result.

Be sure to disconnect all cables before moving the Plasma Display.

- If the Plasma Display is moved while some of the cables are still connected, the cables may become damaged, and fire or electric shock could result.

Disconnect the power cord plug from the wall socket as a safety precaution before carrying out any cleaning.

- Electric shocks can result if this is not done.

Clean the power cable regularly to prevent it becoming dusty.

- If dust built up on the power cord plug, the resultant humidity can damage the insulation, which could result in fire. Pull the power cord plug out from the wall outlet and wipe the mains lead with a dry cloth.

This Plasma Display radiates infrared rays, therefore it may affect other infrared communication equipment. Install your infrared sensor in a place away from direct or reflected light from your Plasma Display.

Cleaning and maintenance

The front of the display panel has been specially treated. Wipe the panel surface gently using only a cleaning cloth or a soft, lint-free cloth.

- If the surface is particularly dirty, wipe with a soft, lint-free cloth which has been soaked in pure water or water to which a small amount of neutral detergent has been added, and then wipe it evenly with a dry cloth of the same type until the surface is dry.
- Do not scratch or hit the surface of the panel with fingernails or other hard objects, otherwise the surface may become damaged. Furthermore, avoid contact with volatile substances such as insect sprays, solvents and thinner, otherwise the quality of the surface may be adversely affected.

If the cabinet becomes dirty, wipe it with a soft, dry cloth.

- If the cabinet is particularly dirty, soak the cloth in water to which a small amount of neutral detergent has been added and then wring the cloth dry. Use this cloth to wipe the cabinet, and then wipe it dry with a dry cloth.
- Do not allow any detergent to come into direct contact with the surface of the Plasma Display. If water droplets get inside the unit, operating problems may result.
- Avoid contact with volatile substances such as insect sprays, solvents and thinner, otherwise the quality of the cabinet surface may be adversely affected or the coating may peel off. Furthermore, do not leave it for long periods in contact with articles made from rubber or PVC.

Accessories

Accessories Supply

Check that you have the accessories and items shown



Operating Instruction book

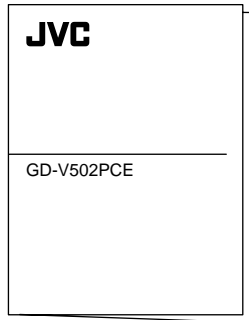

Remote Control Transmitter
EUR646532

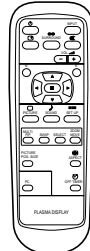

Batteries for the Remote Control Transmitter
(2 × R6 Size)

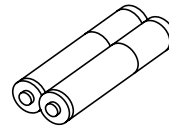

Fixing bands

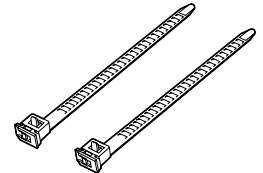

AC cord

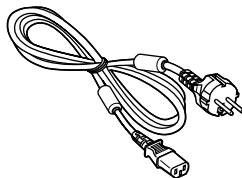

AC cord
(For UK only)

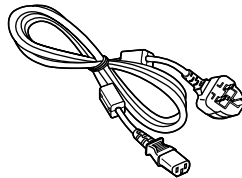

Ferrite core
(small size) × 1

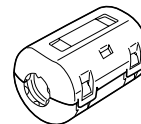

Ferrite core
(large size) × 2

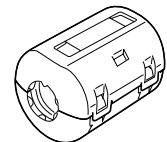

Remote Control Batteries

Requires two R6 batteries.

1. Turn the transmitter face down.
Press and slide off the battery cover.

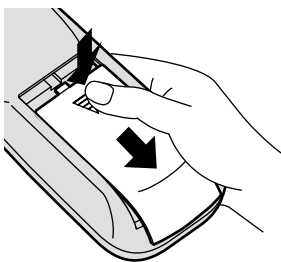

2. Install the batteries as shown in the battery compartment.
(Polarity + or – must match the markings in the compartment.)

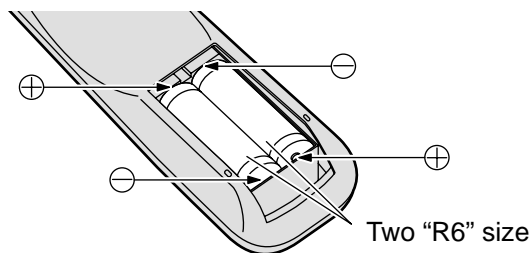

3. Replace the cover and slide in reverse until the lock snaps.

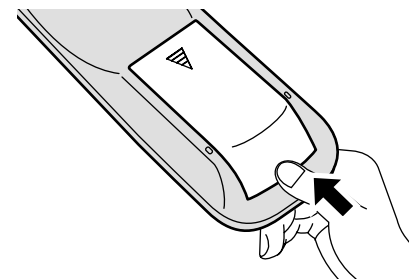

Helpful Hint:

For frequent remote control users, replace old batteries with Alkaline batteries for longer life.

⚠ Precaution on battery use

Incorrect installation can cause battery leakage and corrosion that will damage the remote control transmitter.

Observe the following precaution:

1. Batteries shall always be replaced as a pair. Always use new batteries when replacing the old set.
2. Do not combine a used battery with a new one.
3. Do not mix battery types (example: "Zinc Carbon" with "Alkaline").
4. Do not attempt to charge, short-circuit, disassemble, heat or burn used batteries.
5. Battery replacement is necessary when remote control acts sporadically or stops operating the Plasma Display.

Connections

When connecting the speakers, be sure to use only the optional accessory speakers. Refer to the speaker's Installation Manual for details on speaker installation.

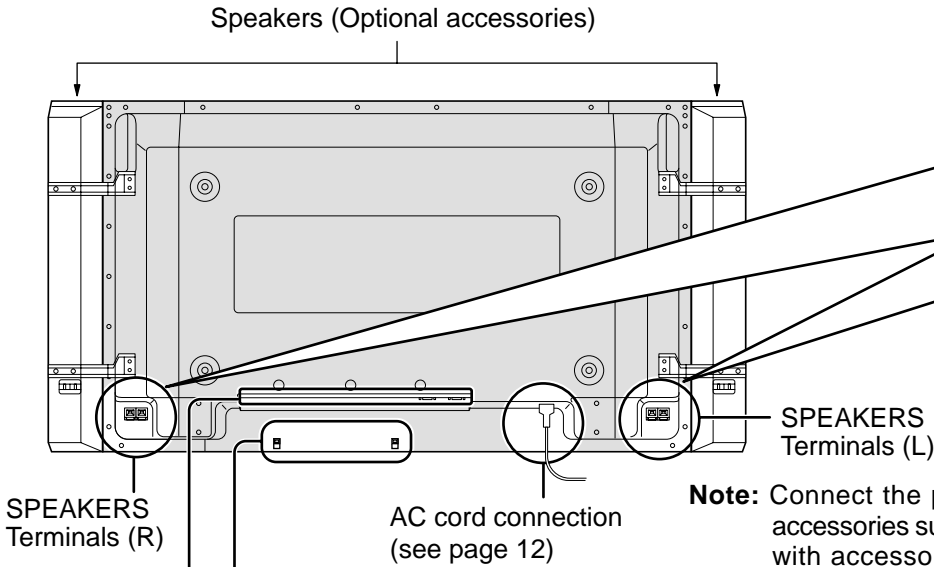
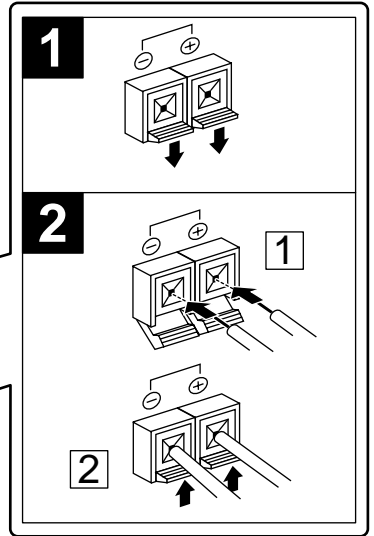

Note: Connect the power cord before combining with accessories such as the pedestal. When combining with accessories such as the pedestal, be very careful not to pinch the power cord.

- AC cord fixing

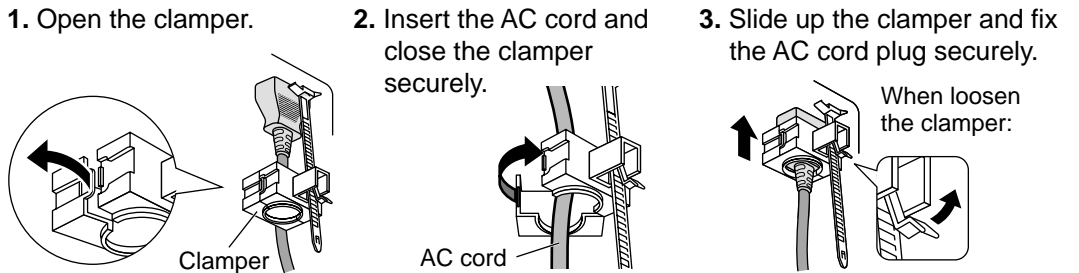

Note: The power plug in the illustration may not be the type fitted to your set.

- Cable fixing bands

Secure any excess cables with bands as required.

Pass the attached cable fixing band through the clip as shown in the figure.

To secure cables connected to Terminals, wrap the cable fixing band around them then pass the pointed end through the locking block, as shown in the figure.

While ensuring there is sufficient slack in cables to minimize stress (especially in the power cord), firmly bind all cables with the supplied fixing band.

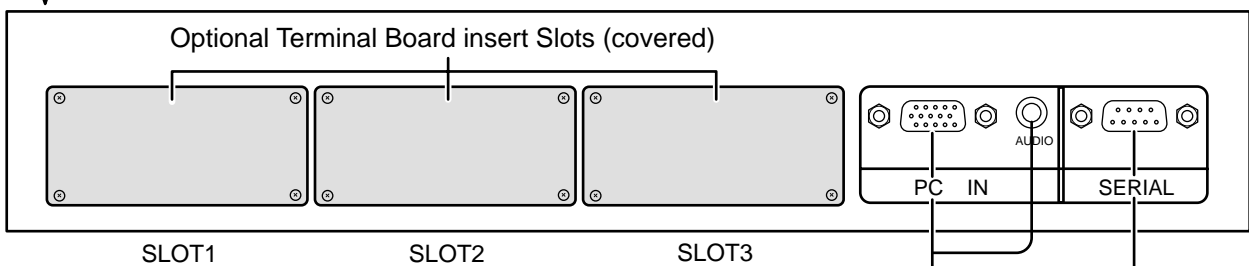
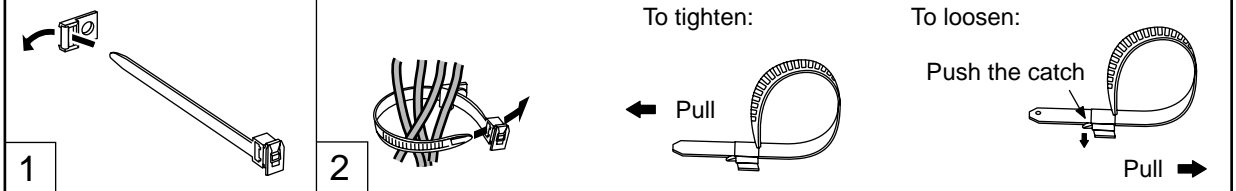

Note: Insert the optional terminal boards before combining the Plasma Display with the pedestal.

From EXTERNAL monitor terminal on Computer (see page 8)

From SERIAL terminal on Computer

PC Input Terminals connection

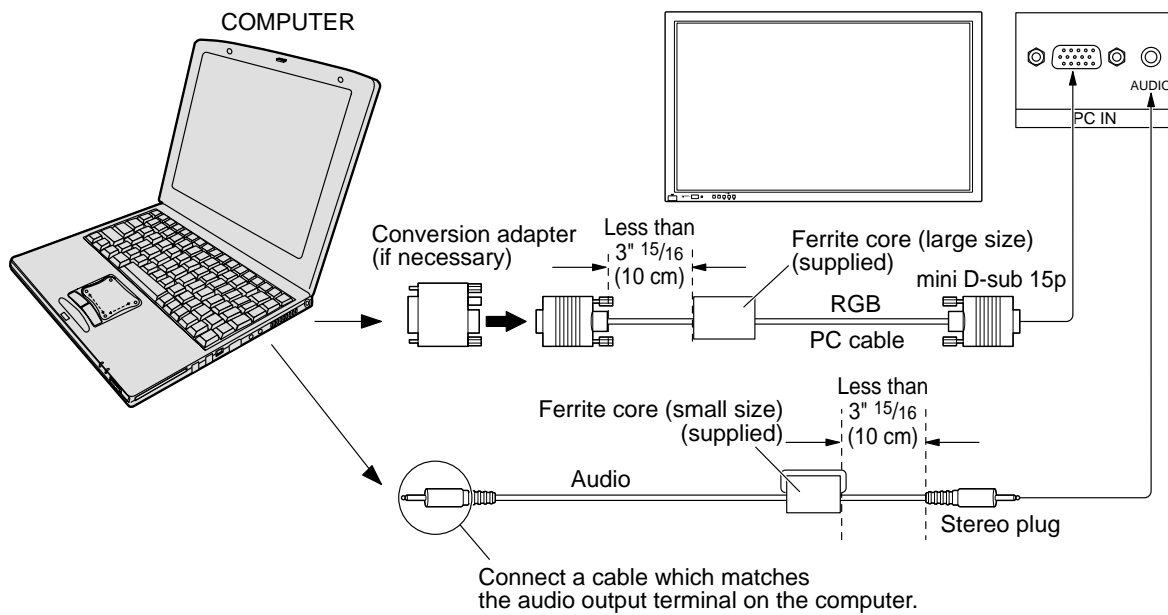

Installing the ferrite core (Small size)

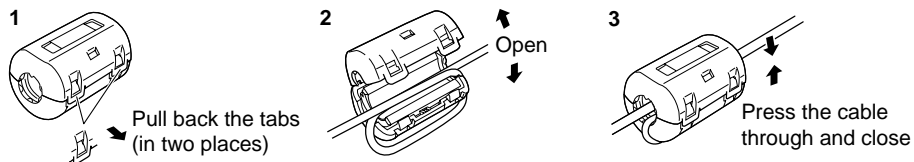

Installing the ferrite core (Large size)

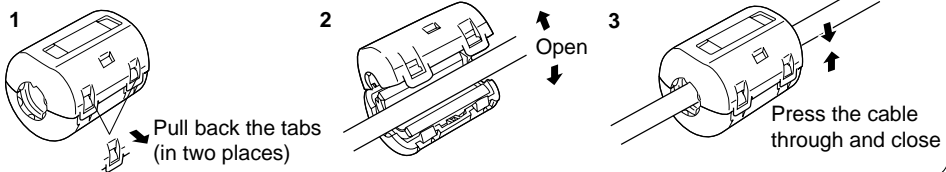

Notes:

- (1) Computer signals which can be input are those with a horizontal scanning frequency of 15 to 110 kHz and vertical scanning frequency of 48 to 120 Hz. (However, the image will not be displayed properly if the signals exceed 1,200 lines.)
- (2) The display resolution is a maximum of 1,024 × 768 dots when the aspect mode is set to "4:3", and 1,366 × 768 dots when the aspect mode is set to "16:9". If the display resolution exceeds these maximums, it may not be possible to show fine detail with sufficient clarity.
- (3) The PC input terminals are DDC1/2B-compatible. If the computer being connected is not DDC1/2B-compatible, you will need to make setting changes to the computer at the time of connection.
- (4) Some PC models cannot be connected to the set.
- (5) There is no need to use an adapter for computers with DOS/V compatible mini D-sub 15P terminal.
- (6) The computer shown in the illustration is for example purposes only.
- (7) Additional equipment and cables shown are not supplied with this set.
- (8) Do not set the horizontal and vertical scanning frequencies for PC signals which are above or below the specified frequency range.
- (9) Component Input is possible with the pin 1, 2, 3 of the mini D-sub 15P Connector.

Signal Names for mini D-sub 15P Connector

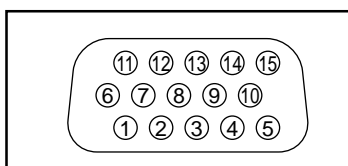

Pin Layout for PC Input Terminal

Pin No.	Signal Name	Pin No.	Signal Name	Pin No.	Signal Name
①	R (Pr/CR)	⑥	GND (Ground)	⑪	GND (Ground)
②	G (Y)	⑦	GND (Ground)	⑫	SDA
③	B (Pb/Cb)	⑧	GND (Ground)	⑬	HD/SYNC
④	GND (Ground)	⑨	NC (not connected)	⑭	VD
⑤	GND (Ground)	⑩	GND (Ground)	⑮	SCL

SERIAL Terminals connection

The SERIAL terminal is used when the Plasma Display is controlled by a computer.

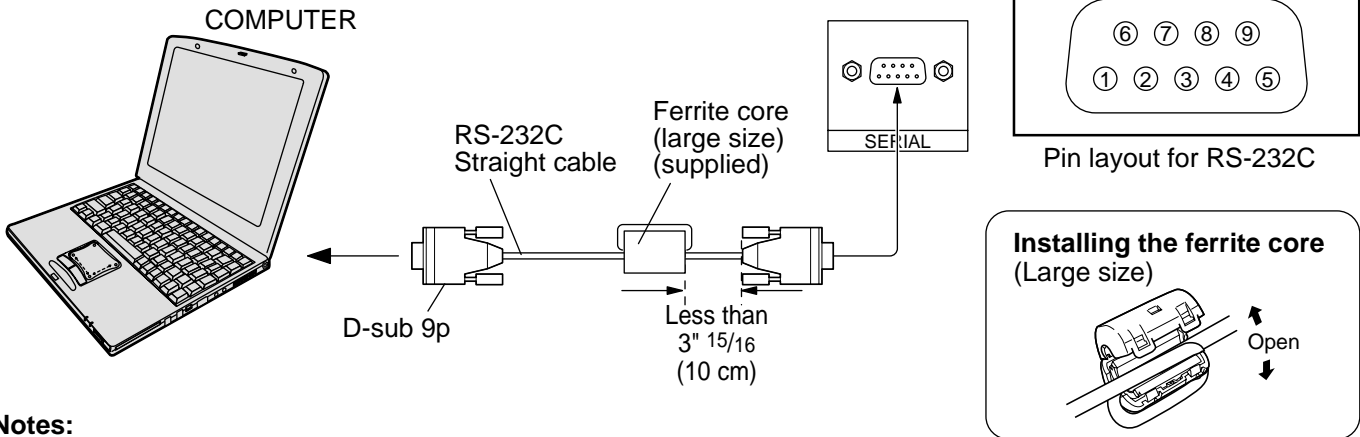

Notes:

- (1) Use the RS-232C cable to connect the computer to the Plasma Display.
- (2) The computer shown is for example purposes only.
- (3) Additional equipment and cables shown are not supplied with this set.

The SERIAL terminal conforms to the RS-232C interface specification, so that the Plasma Display can be controlled by a computer which is connected to this terminal. The computer will require software which allows the sending and receiving of control data which satisfies the conditions given below. Use a computer application such as programming language software. Refer to the documentation for the computer application for details.

Communication parameters

Signal level	RS-232C compliant
Synchronization method	Asynchronous
Baud rate	9600 bps
Parity	None
Character length	8 bits
Stop bit	1 bit
Flow control	-

RS-232C Conversion cable	
D-sub 9-pin female	Details
②	R X D
③	T X D
⑤	GND
④ • ⑥	Non use
⑦ ⑧	Shorted
① • ⑨	NC

Basic format for control data

The transmission of control data from the computer starts with a STX signal, followed by the command, the parameters, and lastly an ETX signal in that order. If there are no parameters, then the parameter signal does not need to be sent.

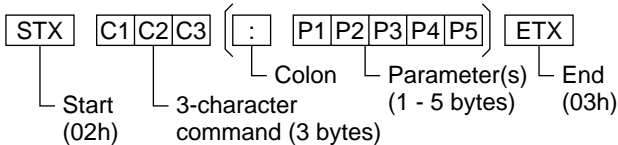

Notes:

- (1) If multiple commands are transmitted, be sure to wait for the response for the first command to come from this unit before sending the next command.
- (2) If an incorrect command is sent by mistake, this unit will send an "ER401" command back to the computer.

Command

Command	Parameter	Control details
PON	None	Power ON
POF	None	Power OFF
AVL	**	Volume 00 - 63
AMT	0	Audio mute OFF
	1	Audio mute ON
IMS	None	Input select (toggle)
	SL1	Slot1 input
	SL2	Slot2 input
	SL3	Slot3 input
	PC1	PC input
DAM	None	Screen mode select (toggle)
	NORM	4 : 3
	ZOOM	Zoom
	FULL	16 : 9
	JUST	Just
	SELF	Auto

With the power off, this display responds to PON command only.

Basic Controls

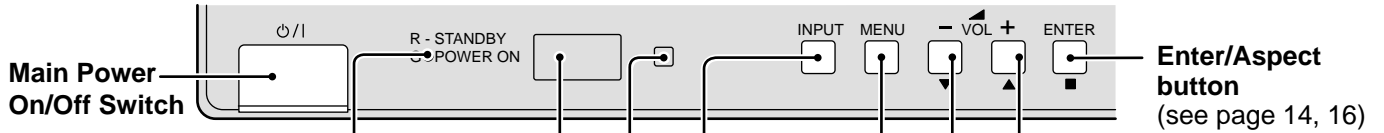

Power Indicator

The Power Indicator will light.

- Power-OFF .. Indicator not illuminated (The unit will still consume some power as long as the power cord is still inserted into the wall outlet.)
- Stand-by ϕ Red
- Power-ON Green
- DPMS Orange (With PC input signal and during operation of PC's screensaver.)

C.A.T.S sensor

Plasma C.A.T.S (Contrast Automatic Tracking System)

Plasma C.A.T.S automatically senses the ambient light conditions and adjusts the brightness and gradation accordingly, to optimise contrast. (Effective when Picture mode is set to Auto.)

MENU Screen ON/OFF

Each time the MENU button is pressed, the menu screen will switch. (see page 14)



INPUT button

(INPUT1, INPUT2, INPUT3 and PC IN Selection)

(see page 13)

Volume Adjustment

Volume Up "+" Down "-"

When the menu screen is displayed.

"+": press to move the cursor up

"-": press to move the cursor down

Status button

Press the "Status" button to display the current system status.

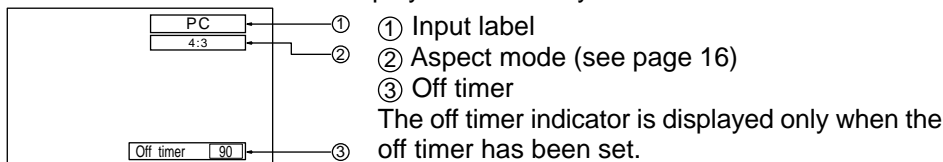

N button

(see page 17-20)

PICTURE button

(see page 18)

MULTI PIP

Each time pressing this button main picture and sub picture will be displayed as follows below.

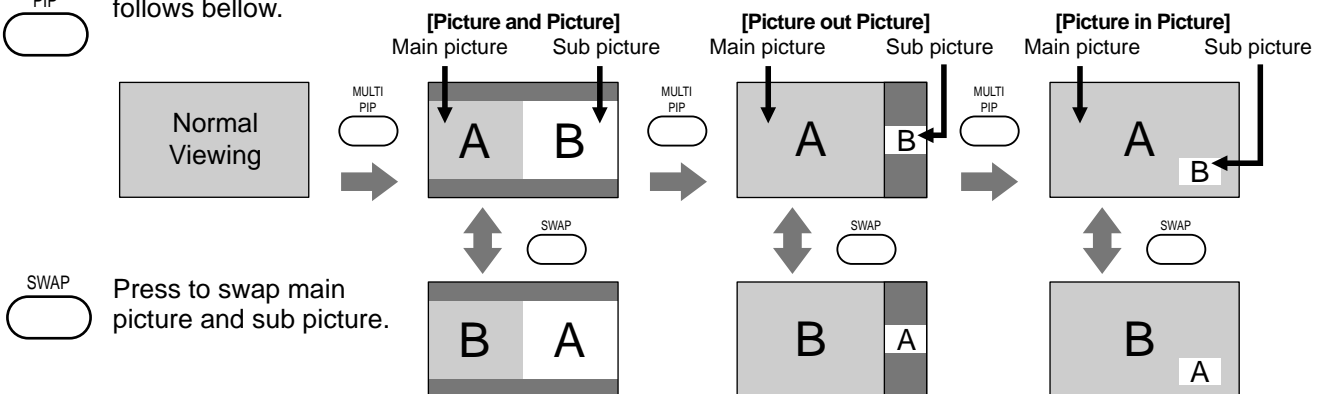

[Example]

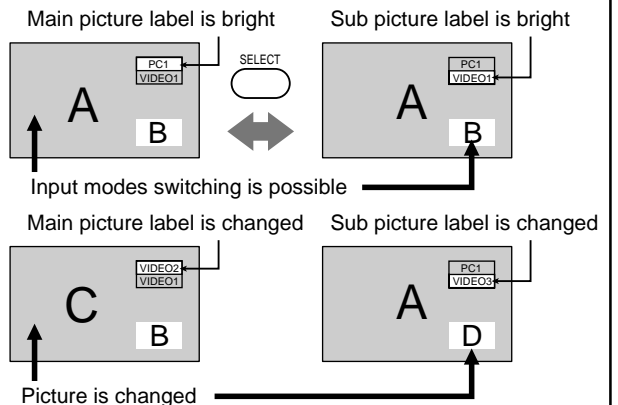

SELECT

Press the SELECT button. Under main Picture and sub picture display, select the picture which you would like to change input modes.

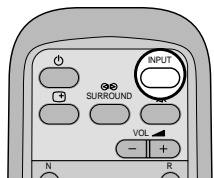

INPUT

Press to change input signal.

ZOOM MOVE

Press the MOVE button. Each time the location of the sub picture will be moved.

- Notes:** (1) This button is effective only in the picture in picture.
 (2) The sub picture may be hidden by the on screen display, depending on its position.

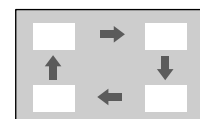

- Notes:** (1) Sound output is from the main picture.
 (2) Using this function to display picture in picture for the purpose of public display or commercial gain may infringe on copyright laws.

Stand-by (ON/OFF) button

The Plasma Display must first be plugged into the wall outlet and turned on at the power switch (see page 12). Press this button to turn the Plasma Display On, from Stanby mode. Press it again to turn the Plasma Display Off to Stanby mode.

SURROUND button

The benefits of surround sound are enormous. You can be completely enveloped in sound; just as if you were at a concert hall or cinema.

The surround setting switches on and off each time the SURROUND button is pressed.

On \longleftrightarrow Off

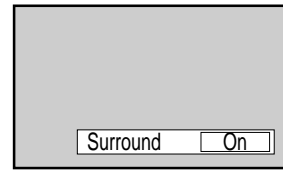

Note:

The surround settings are memorized separately for each Sound mode (Normal, Auto).

INPUT button

(INPUT1, INPUT2, INPUT3 and PC IN Selection)

Press to select INPUT1, INPUT2, INPUT3 and PC IN input SLOTS sequentially. (see page 13)

Sound mute On/Off (see page 20)

Volume Adjustment

Press the Volume Up “+” or Down “-” button to increase or decrease the sound volume level.

R button (see page 14-15)

Press the R button to return to previous menu screen.

ACTION button

Press to make selections.

POSITION buttons

SOUND button (see page 20)

Press to adjust the SOUND.

SET UP button

(see page 14-15)

PICTURE POS./SIZE button

(see page 17)

ASPECT button

Press to adjust the aspect.

(see page 16)

OFF TIMER button

The Plasma Display can be preset to switch to stand-by after a fixed period. The setting changes to 30 minutes, 60 minutes, 90 minutes and 0 minutes (off timer cancelled) each time the button is pressed.

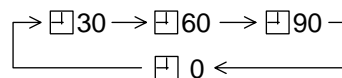

When three minutes remain, “Off timer 3” will flash. The off timer is cancelled if a power interruption occurs.

Digital Zoom (see page 21)

ZOOM
MOVE

Press to access Digital Zoom.

This displays an enlargement of the designated part of the displayed image.

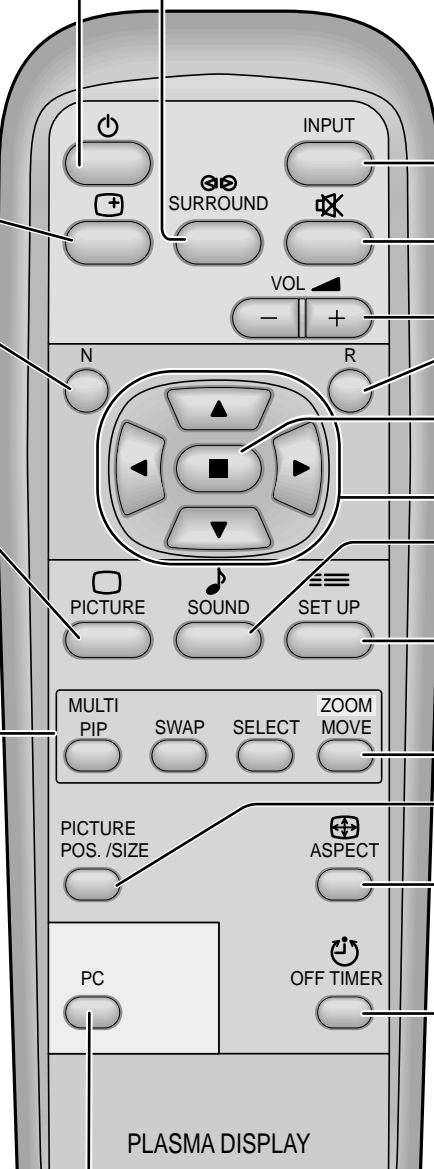
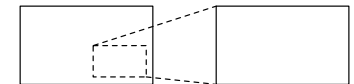

PC button

Press the “PC” input mode selection button to select the PC input mode.

This button is used to switch directly to PC input mode.

Note:

In 2 screen display, the same input mode cannot be selected for the main picture and sub picture.

Power On/Off and input signal selection

AC cord connection

Connecting the AC cord plug to the Plasma Display.

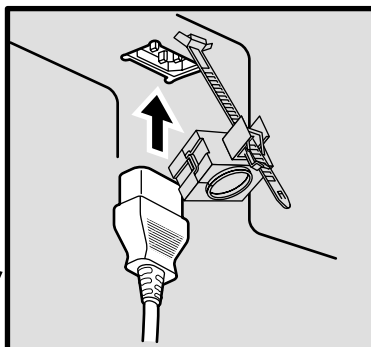
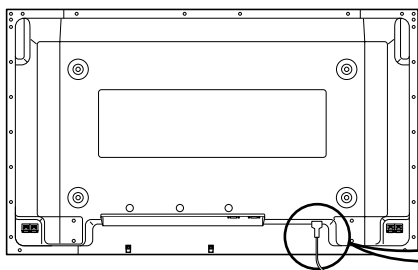

Fix the AC cord plug securely to the Plasma Display with the clammer. (see page 7)

Power On/Off

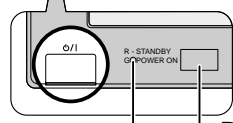
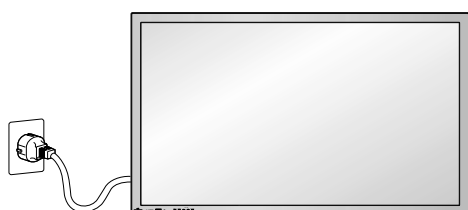

Power Indicator Remote Control Sensor

Connecting the AC plug to the Wall Outlet

Note:

AC plug types vary between countries/regions.

Press the Main power switch on the Plasma Display to turn the Plasma Display on: Power-On.

Power Indicator: Green

If the power indicator is lit red, press the power button on the remote control to turn the Plasma Display on.

Example: The screen below is displayed for a while after the Plasma Display is turned on. (setting condition is an example.)

When the Power is turned on for the first time, the Language selection screen is displayed.

From the second time on, language selection can be done from the setup menu. (see page 13)

Select the desired language using the ▲ and ▼ keys and press the ACTION button.



From the second time on, the below screen is displayed for a while (setting condition is an example).

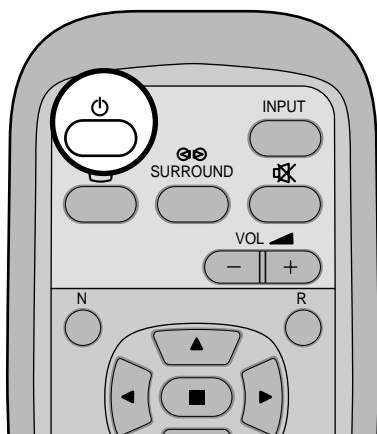
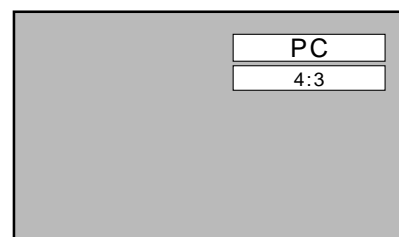

Press the  button on the remote control to turn the Plasma Display off.

Power Indicator: Red (standby)

Press the  button on the remote control to turn the Plasma Display on.

Power Indicator: Green

Turn the power to the Plasma Display off by pressing the  Main power switch on the Plasma Display, when the Plasma Display is on or in standby mode.

Note: During operation of the power management function, the power indicator turns orange in the power off state.

Select the input signal

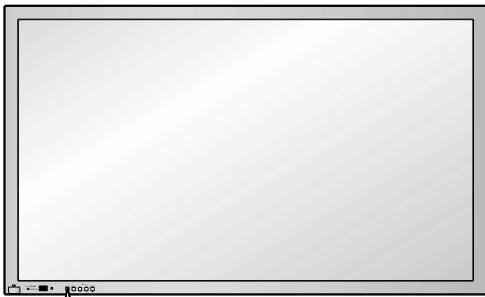

Press the INPUT button to select the input signal to be played back from the equipment which has been connected to the Plasma Display.

Select the input signals to be connected by installing the optional Terminal Boards.

Input signals will change as follows:

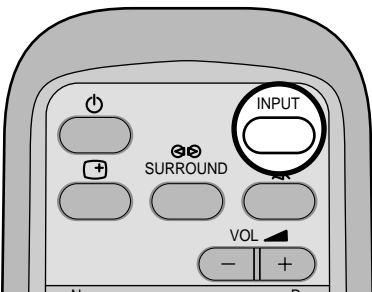
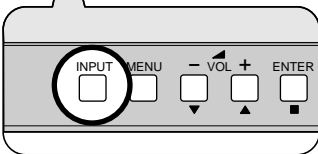
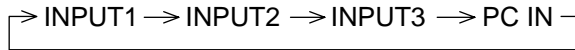

Notes:

- (1) Input terminal will not be selected if the terminal board is not installed into the SLOT.
- (2) Select to match the signals from the source connected to the component/RGB input terminals. (see page 30)
- (3) In 2 screen display, the same input mode cannot be selected for the main picture and sub picture.

Selecting the On-Screen Menu Language

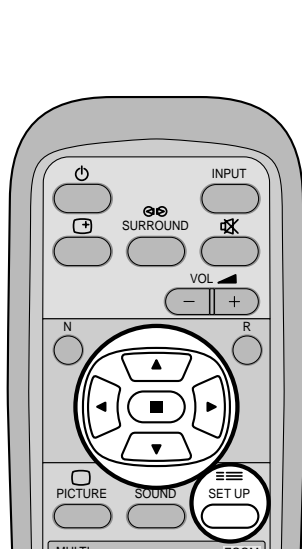

Press to display the Set Up menu.

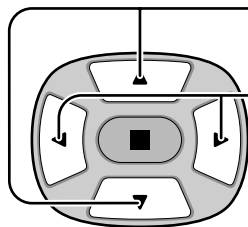

Press to select the OSD Language.

Press to select your preferred language.

Selectable languages

- English(UK)
- Deutsch
- Français
- Italiano
- Español
- ENGLISH(US)
- 中文(Chinese)

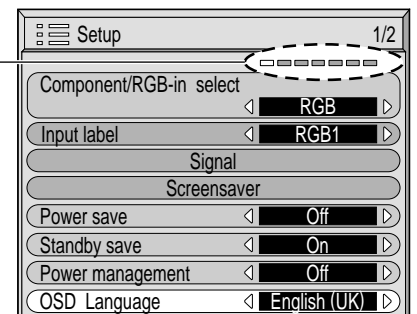

On-Screen Menu Displays

To Picture adjust menu
(see page 18)

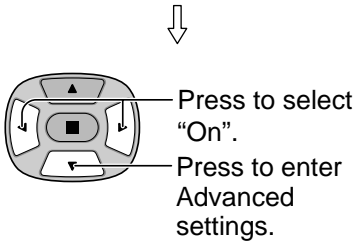
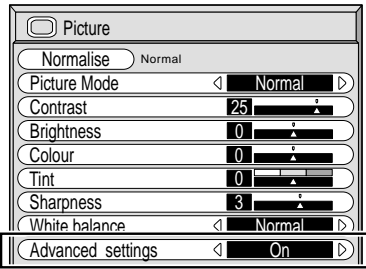

To Advanced settings
(see page 18, 19)

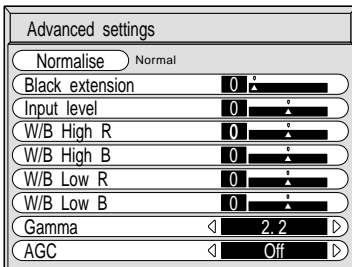

To Sound adjust menu
(see page 20)

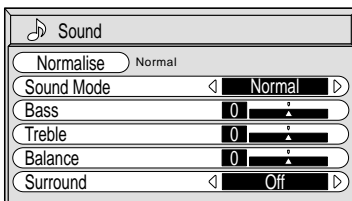

The MENU button on the unit can also be pressed.

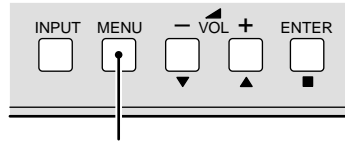

Each time the MENU button is pressed, the menu screen will switch.

➤ Normal Viewing → Picture → Set up
Sound ← Picture Pos./ Size ←

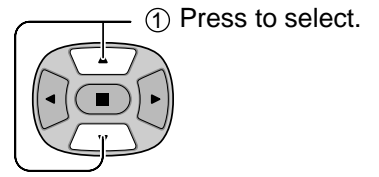
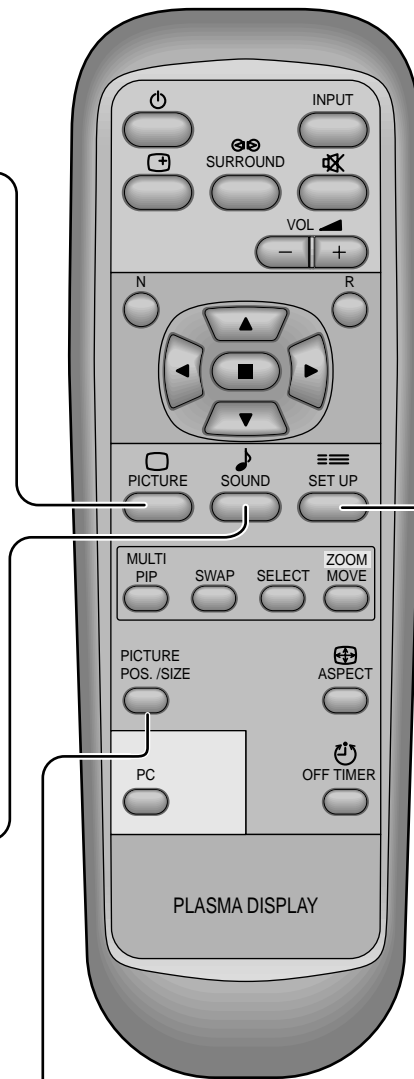

[from the unit]

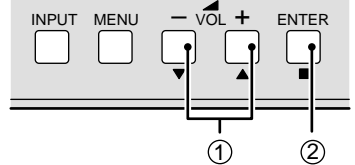

① Press to select.
② Press to access each adjust screen.

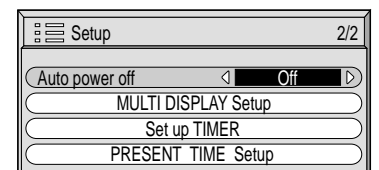
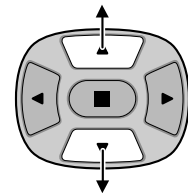
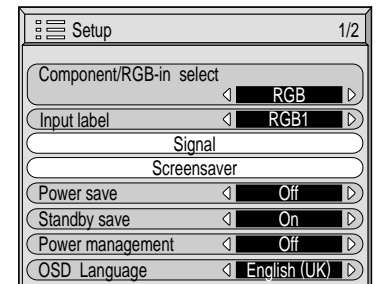

To Picture Pos./Size adjust menu (see page 17)

During "AV(S Video)" and "Component" input signal.

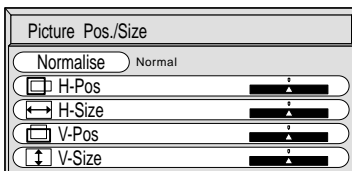

During "RGB" and "PC" input signal.

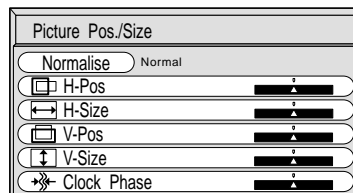

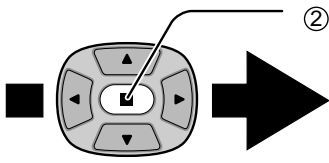

② Press to access each adjust screen.

[from the unit]

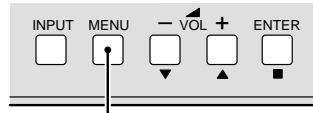

Press to return to previous menu screen.

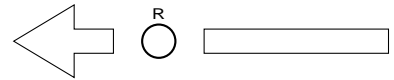

Press the R button to return to previous menu screen.

To Signal screen for AV(S Video)
(see page 30, 31)

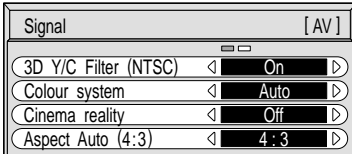

To Signal screen for Component
(see page 31)

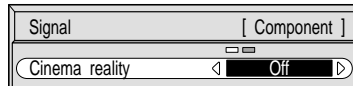

To Signal screen for RGB and PC
(see page 32)

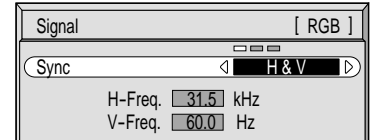

Note: "Signal" setup menu displays different setting condition for each input signals. (see page 13)

To setup Screensaver
(see page 24-26)

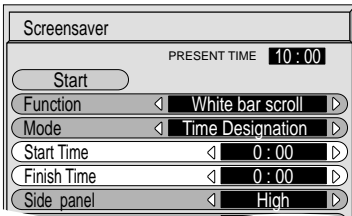

Press to select Start Time/ Finish Time
(When Time Designation is selected).
Press to select Periodic Time/ Operating Time
(When Interval is selected).

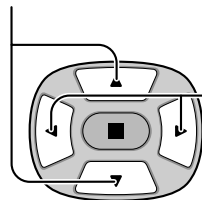

Press to Setup.

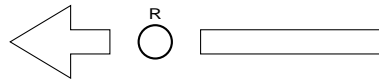

Press the R button to return to "Screensaver" menu.

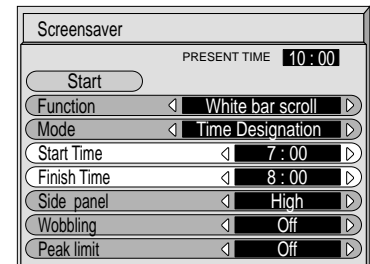

To setup Multidisplay screen
(see page 28)

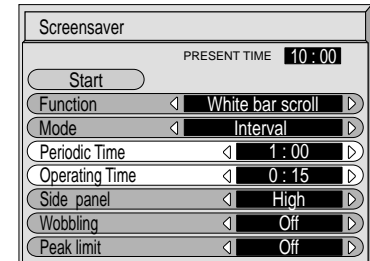
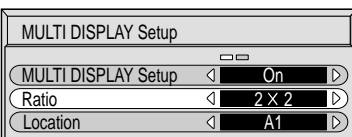

To Set up Timer selection
screen (see page 22, 23)

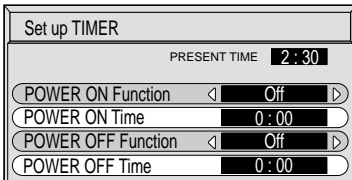

Press to select POWER ON
Time / POWER OFF Time.

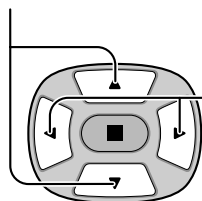

Press to Set up
POWER ON Time /
POWER OFF Time.

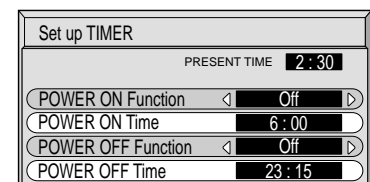

To PRESENT TIME Setup
(see page 22)

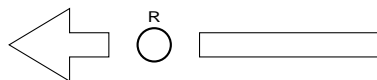
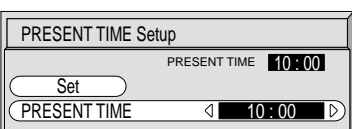

Press the R button to return
to "Set up TIMER" menu.

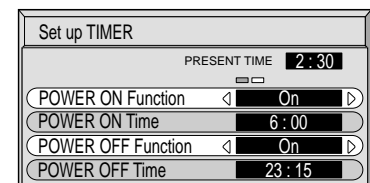

ASPECT Controls

The Plasma Display will allow you to enjoy viewing the picture at its maximum size, including wide screen cinema format picture.

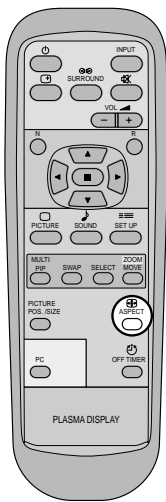

ASPECT button

The aspect mode changes each time the ASPECT button is pressed.

[from the unit]

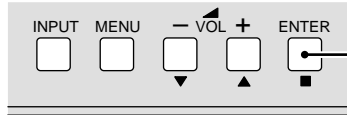

The aspect mode changes each time the ENTER button is pressed.

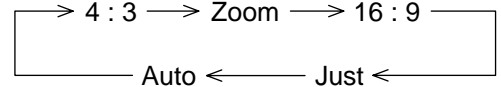

[During MULTI PIP Operations]

(1) Picture and Picture, Picture in Picture :



(2) Others

: Aspect switching is not possible.

Notes:

- For PC signal input, the mode switches between "4:3", "Zoom" and "16:9" only.
- For a 1125 (1080) / 60i · 50i · 24p · 24sF, 1250 (1080) / 50i, 750 (720) / 60p · 50p signal input during "Component" and "RGB" input signal, the mode is set to "16:9" mode, and switching is not possible. Auto can be selected only during Video signal input.
- The aspect mode is memorized separately for each input terminal (INPUT1, INPUT2, INPUT3 and PC IN).

Mode	Picture	Explanation
4 : 3		4:3 will display a 4:3 picture at its standard 4:3 size.
Zoom		Zoom mode magnifies the central section of the picture.
16 : 9		16:9 will display the picture at its maximum size but with slight elongation.
Just		Just mode will display a 4:3 picture at its maximum size but with aspect correction applied to the center of the screen so that elongation is only apparent at the left and right edges of the screen. The size of the picture will depend on the original signal.
Auto	<p>For an elongated image Image is expanded</p> <p>For a 4:3 image</p> <p>Changes in accordance with the Auto mode setting (see page 31).</p>	<p>The display will automatically become enlarged (depending on the picture source), allowing you to view the picture at its maximum size.</p> <p>Note: Auto mode is designed to automatically adjust the aspect ratio to handle a mix of 16:9 and 4:3 program material. Certain 4:3 program material, such as stock market data screens, may occasionally cause the image size to change unexpectedly. When viewing such programs, it is recommended that the ASPECT be set to 4:3.</p>

Notes: (1) Do not allow the picture to be displayed in 4:3 mode for an extended period, as this can cause a permanent after-image to remain on the Plasma Display Panel.

(2) Using this function to display a picture with the aspect ratio changed from the original for the purpose of public display or commercial gain may infringe on copyright laws.

Adjusting Picture Pos./Size

Adjusting screen

1 PICTURE POS./SIZE
 Press to display the Picture Pos./Size menu.

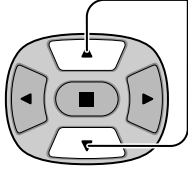
2  Press to select H-Pos/H-Size/V-Pos/V-Size/Clock Phase.

During "AV(S Video)" and "Component" input signal.

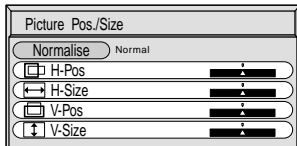

During "RGB" and "PC" input signal.

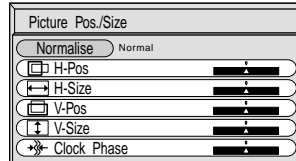

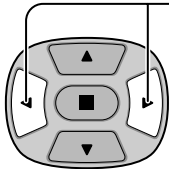
3  Press to adjust Pos./Size.

 Press to exit from adjust mode.

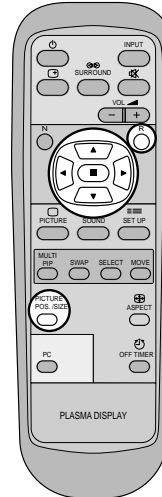

Notes:

(1) Adjustment details are memorized separately for different input signal formats (Adjustments for component signals are memorized for 525 (480) / 60i · 60p, 625 (575) / 50i · 50p, 1125 (1080) / 60i · 50i · 24p · 24sF, 1250 (1080) / 50i, 750 (720) / 60p · 50p each, and RGB signals are memorized for each frequency.)

(2) If a "Cue" or "Rew" signal from a VCR or DVD player is received, the picture position will shift up or down. This picture position movement cannot be controlled by the Picture Pos./Size function.

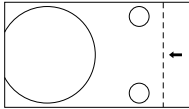
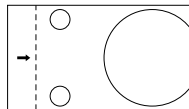
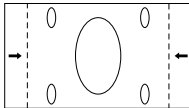
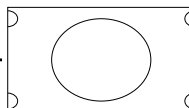
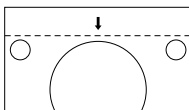
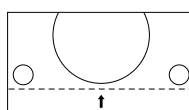
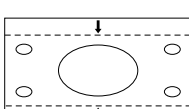
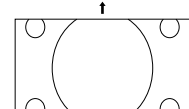
H-Pos	When the Position Left "◀" button is pressed. 	When the Position Right "▶" button is pressed. 
H-Size	When the Position Left "◀" button is pressed. 	When the Position Right "▶" button is pressed. 
V-Pos	When the Position Left "◀" button is pressed. 	When the Position Right "▶" button is pressed. 
V-Size	When the Position Left "◀" button is pressed. 	When the Position Right "▶" button is pressed. 
Clock Phase (RGB/PC in Mode)	Flickering and distortion can be eliminated by using the Position Left "◀" or Right "▶" button to carry out adjustment.	

Note: Using the size adjustment function to display a picture with the aspect ratio changed from the original for the purpose of the public display or commercial gain may infringe on copyright laws.

Helpful Hint (/ Normalisation)

While the Picture Pos./Size display is active, if either the N button on the remote control is pressed at any time or the  (ACTION button) is pressed during "Normalise", then all adjustment values are returned to the factory settings.

Picture Adjustments

1  Press to display the Picture menu.

2 Select to adjust each item.

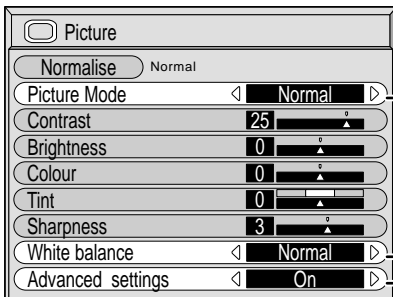
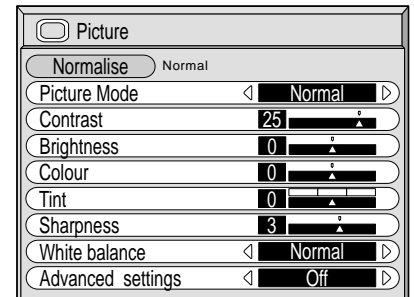
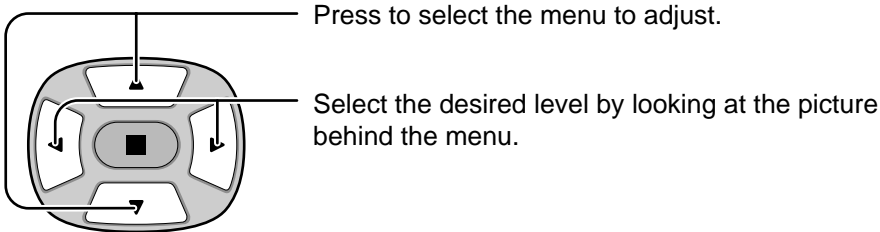

Press the left ◀ or right ▶ button to switch between modes.

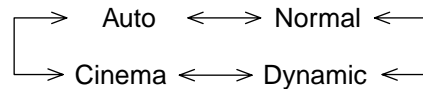

Auto

Automatically selects the mode that best suits the brightness of the environment.

Normal

For viewing in standard (evening lighting) environments.

This menu selects the normal levels of Brightness and Contrast.

Dynamic

For viewing in brighter environments.

This menu selects higher than normal levels of Brightness and Contrast.

Cinema

Ideal for movies.

Note:

If you would like to change the picture and colour of the selected Picture menu to something else, adjust using the items in the Picture menu. (see next page)

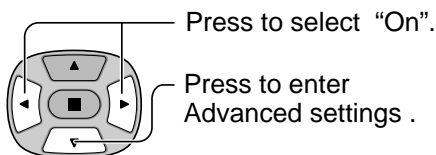



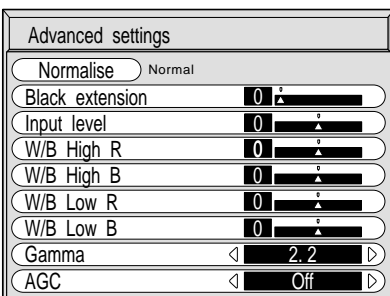

Advanced settings On
Enables fine picture adjustment at a professional level (see next page).

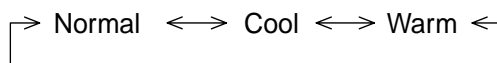

Advanced settings Off
Displays images with settings of the Picture menu.

Press the left ◀ or right ▶ button to switch between modes.



 **Helpful Hint** ( /  **Normalisation**)

While the "Picture" menu is displayed, if either the N button on the remote control is pressed at any time or the  (ACTION button) is pressed during "Normalise", then all adjustment values are returned to the factory settings.

Item	Effect	Adjustments
Contrast	◀ Less ▶ More	Selects the proper brightness and density for the room.
Brightness	◀ Darker ▶ Brighter	Adjusts for easier viewing of dark pictures such as night scenes and black hair.
Colour	◀ Less ▶ More	Adjusts colour saturation.
Tint (NTSC only)	◀ Reddish ▶ Greenish	Adjust for nice skin colour.
Sharpness	◀ Less ▶ More	Adjusts picture sharpness.

Notes:

- (1) "Colour" and "Tint" settings cannot be adjusted for "RGB" and "PC" input signal.
- (2) You can change the level of each function (Contrast, Brightness, Colour, Tint, Sharpness) for each Picture menu.
- (3) The setting details for normal, dynamic and cinema respectively are memorized separately for each input mode (INPUT1, INPUT2, INPUT3 and PC IN).
- (4) The "Tint" setting can be adjusted for NTSC signal only during "AV (S Video)" input signal.

Note:

In PICTURE, there is not a noticeable change even when contrast is increased with a bright picture or reduced with a dark picture.

Advanced settings

Item	Effect	Details
Black extension	◀ Less ▶ More	Adjusts the dark shades of the image in gradation. (This cannot be adjusted when the input signal is RGB or PC.)
Input level	◀ Less ▶ More	Adjustment of parts which are extremely bright and hard to see.
W/B High R	◀ Less ▶ More	Adjusts the white balance for light red areas.
W/B High B	◀ Less ▶ More	Adjusts the white balance for light blue areas.
W/B Low R	◀ Less ▶ More	Adjusts the white balance for dark red areas.
W/B Low B	◀ Less ▶ More	Adjusts the white balance for dark blue areas.
Gamma	◀ Down ▶ Up	S Curve ←→ 2.0 ←→ 2.2 ←→ 2.5
AGC	◀ Off ▶ On	Increases the brightness of dark signal automatically.

Notes:

- (1) Carry out "W/B" adjustment as follows.
 - Ⓐ Adjust the white balance of the bright sections using the "W/B High R" and "W/B High B" settings.
 - Ⓑ Adjust the white balance of the dark sections using the "W/B Low R" and "W/B Low B" settings.
 - Ⓒ Repeat steps Ⓐ and Ⓑ to adjust.

Steps Ⓐ and Ⓑ affect each other's settings, so repeat each step in turn to make the adjustment.
- (2) The adjustment values are memorized separately for each input mode (INPUT1, INPUT2, INPUT3 and PC IN).
- (3) The adjustment range values should be used as an adjustment reference.

Helpful Hint (/ Normalisation)

On the remote control unit, while the "Advanced settings" menu is displayed, if either the N button is pressed at any time or the  (ACTION button) is pressed during "Normalise", then all adjustment values are returned to the factory settings.

Sound Adjustment

1  Press to display the Sound menu.

2 Select to adjust each item.

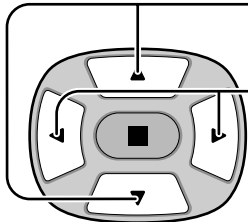
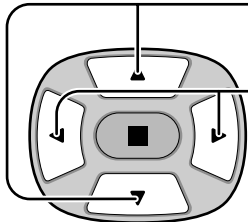
 Press to select the desired adjustment menu.
 Select the desired level by listening to the sound.

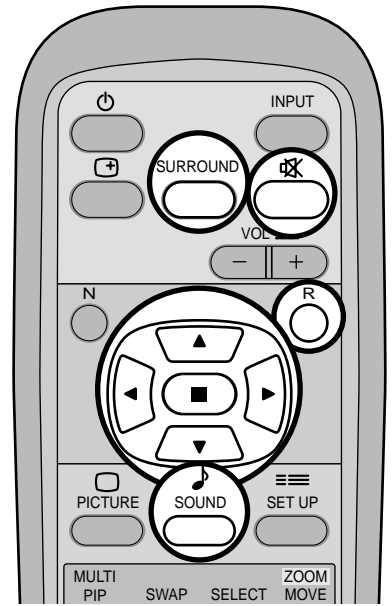

Bass
Adjusts low sounds

Treble
Adjusts high sounds

Balance
Adjusts left and right volumes

Surround
Select On or Off

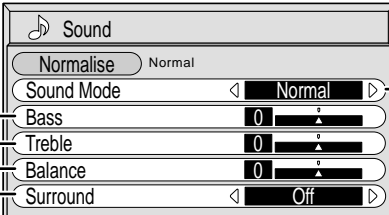

Normal Emits the original sound.

↕

Auto Automatically controls proper volume level.

• To end adjustments

 Press the R button

Note:

Press the SURROUND button to directly turn the surround effect On and Off. (see page 11)
 Bass, Treble and Surround settings are memorized separately for each Sound mode (Normal, Auto).

Helpful Hint (N / Normalise) **Normalisation**

While the "Sound" menu is displayed, if either the N button on the remote control is pressed at any time or the  (ACTION button) is pressed during "Normalise", then all adjustment values are returned to the factory settings.

Mute

Useful when answering the phone or receiving unexpected visitors.

 Press this button to mute the sound.
 Press again to reactivate sound. Sound is also reactivated when power is turned off or volume level is changed.

Digital Zoom

This displays an enlargement of the designated part of the displayed image.

1 Display the "Operation Guide".

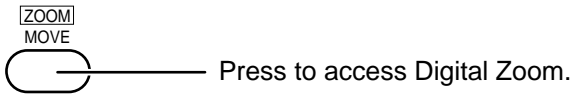

The "Operation Guide" will be displayed.

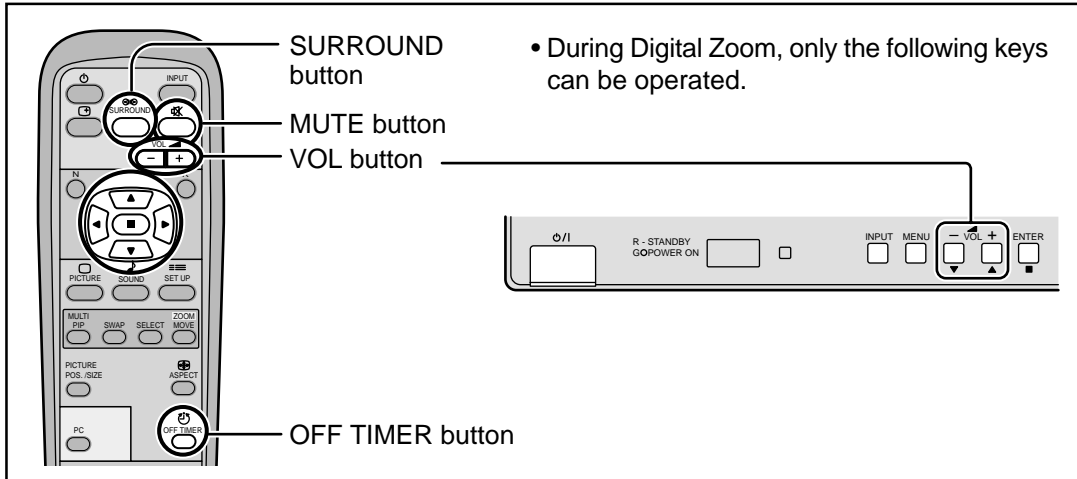
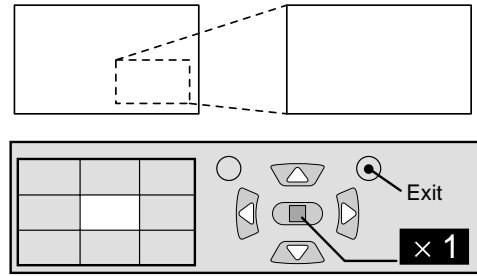

2 Select the area of the image to be enlarged.

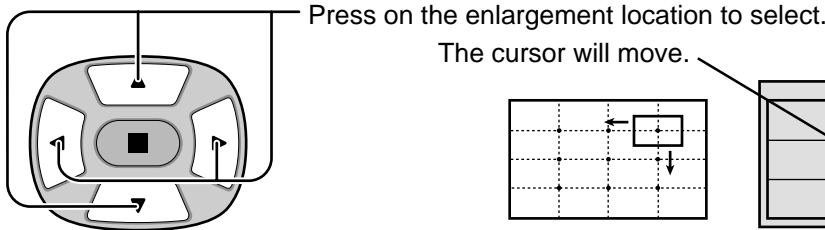

3 Select the magnification required for the enlarged display.

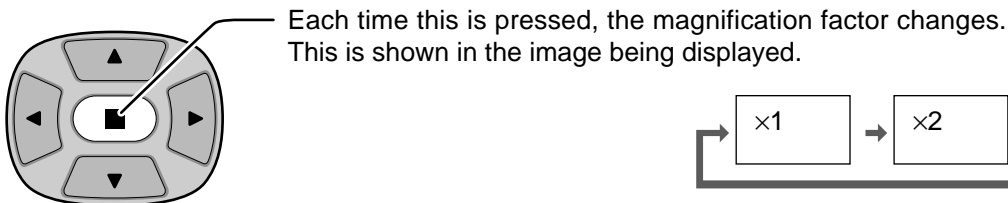

4 Return to normal display (quit Digital Zoom).

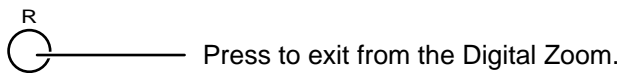

Notes:

- (1) When power goes OFF (including "Off Timer" operation), Digital Zoom terminates.
- (2) The Digital Zoom function cannot be selected while in the following operation states:
 - "Multi-screen" (MULTI DISPLAY). (see page 28)
 - "Multi-viewer" (Picture in Picture, Picture out Picture, Picture and Picture) operation. (see page 10)
- (3) While Digital Zoom is in operation, "Adjusting Picture Pos./Size" cannot be used.
- (4) For RGB/PC input signals, normal multi-display magnification is only available at the VGA, SVGA and XGA resolution.
- (5) The Digital Zoom capability is functional for the following component signals:
 - 525 (480) / 60i · 60p, 625 (575) / 50i · 50p, 1125 (1080) / 60i · 50i · 24sF, 750 (720) / 60p · 50p, 1250 (1080) / 50i
- (6) The Digital Zoom capability is functional for the following composite signals: NTSC, PAL, SECAM
- (7) Using this function to display an enlarged picture for the purpose of public display or commercial gain may infringe on copyright laws.

PRESENT TIME Setup / Set up TIMER

The timer can switch the Plasma Display On or Off.

Before attempting Timer Set, confirm the PRESENT TIME and adjust if necessary. Then set POWER ON Time / POWER OFF Time.

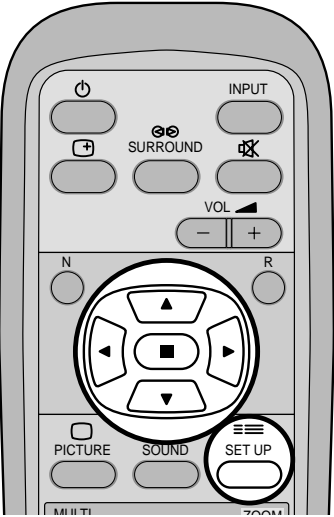

1  Press to display the Setup menu screen.

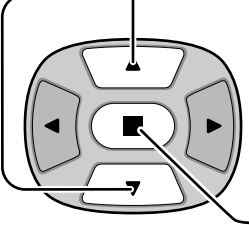
2  Press to select Set up TIMER or PRESENT TIME Setup.

 Press to display the Set up TIMER screen or PRESENT TIME Setup screen.

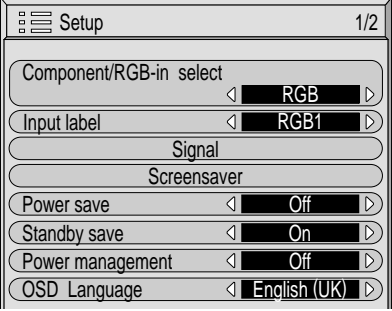

Setup	1/2
Component/RGB-in select	RGB
Input label	RGB1
Signal	
Screensaver	
Power save	Off
Standby save	On
Power management	Off
OSD Language	English (UK)

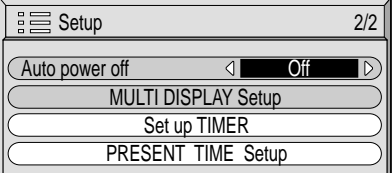

Setup	2/2
Auto power off	Off
MULTI DISPLAY Setup	
Set up TIMER	
PRESENT TIME Setup	

PRESENT TIME Setup

Display the PRESENT TIME Setup screen.

To set up PRESENT TIME, follow the procedure described below.

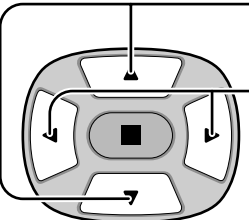
1  Press to select PRESENT TIME.

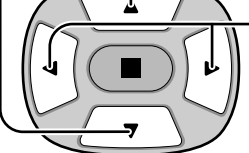
 Press to set up PRESENT TIME.
 ▶ button: Forward
 ◀ button: Back

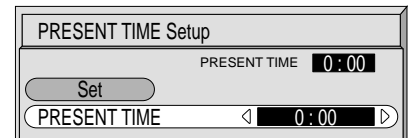

Notes:

- Pressing "◀" or "▶" button once changes PRESENT TIME 1minute.
- Pressing "◀" or "▶" button continuously changes PRESENT TIME by 15 minutes.

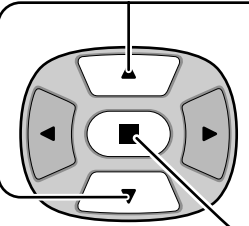
2  Press to select Set.

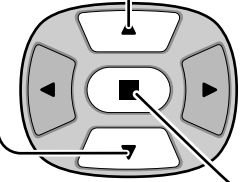
 Press to store PRESENT TIME Setup.

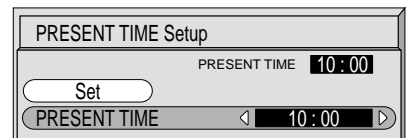

Note:

Set cannot be selected unless PRESENT TIME is set.

 Press to exit from PRESENT TIME Setup.

Set up TIMER

Display the Set up TIMER screen.

1

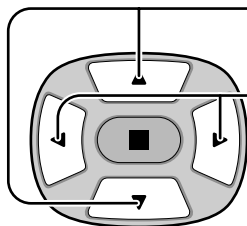

Press to select
POWER ON Time / POWER OFF Time.

Press to set up
POWER ON Time / POWER OFF Time.

▶ button: Forward

◀ button: Back

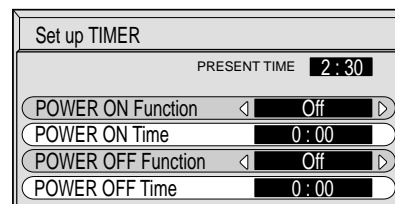

Notes:

- Pressing “◀” or “▶” button once changes POWER ON Time / POWER OFF Time 1minute.
- Pressing “◀” or “▶” button continuously changes POWER ON Time / POWER OFF Time by 15 minutes.

2

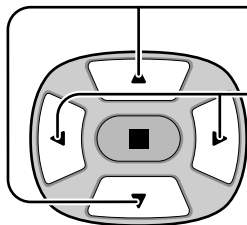

Press to select POWER ON Function/
POWER OFF Function.

Press to select On.

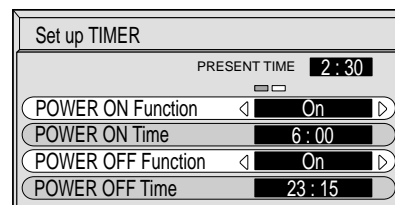

3



Press twice to exit from Setup.

Note:

Timer function will not work unless “PRESENT TIME” is set.

Screensaver (For preventing after-images)

Do not display a still picture, especially in 4:3 mode, for any length of time.
If the display must remain on, a Screensaver should be used.

1  Press to display the Setup menu screen.

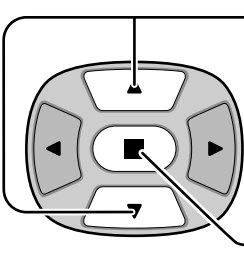
2  Press to select the Screensaver.
Press to select the Screensaver screen.

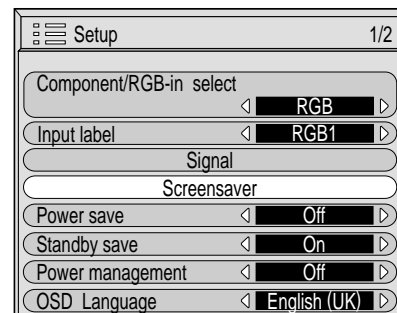

Reversal / Scroll selection

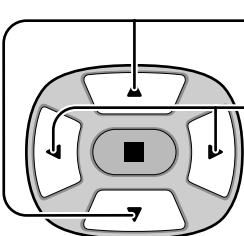
3  Press to select the Function.
Press to select the desired function.
White bar scroll ↔ Image Reversal

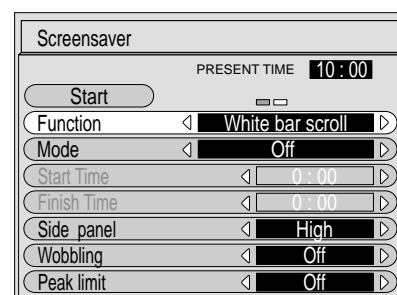

White bar scroll : The white bar will scroll from left to right.
Image Reversal : Negative image will be displayed on the screen.

Mode selection

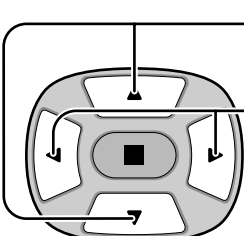
4  Press to select the Mode.
Press to select each mode items.

- Off
- ↕ Interval : Operates when Periodic Time and Operating Time are setup and those times arrive.
- ↕ Time Designation : Operates when Start Time and Finish Time are setup and those times arrive.
- On : Operates when Start is selected and the  (ACTION) is pressed.

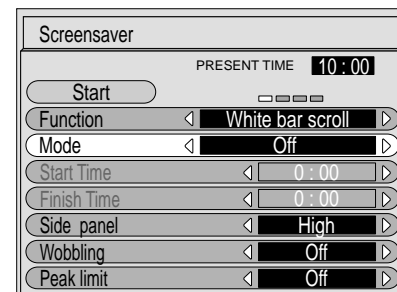

Start setting

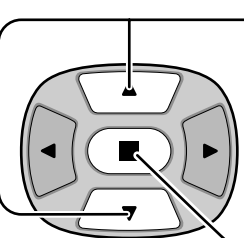
5  When the Mode is set to On, press to select Start.
Press to start Screensaver.

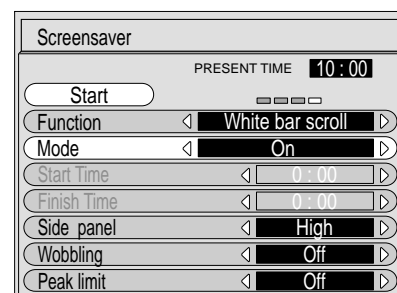

The menu screen will disappear and the Screensaver will be activated. **To stop the Screensaver under On, press the  button.**

Note: This function does not guarantee the complete prevention of permanent afterimages. The potential for the occurrence of permanent afterimages is merely decreased.

Setup of Screensaver Time

After selecting Time Designation or Interval, the relevant Time Setup will become available for selection and the Operating Time may be set. (Time cannot be set when "Mode" is "on" or "off.")

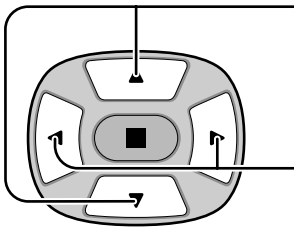
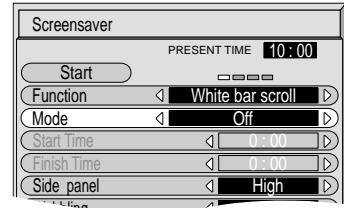
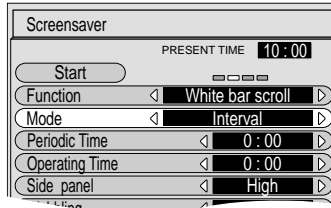
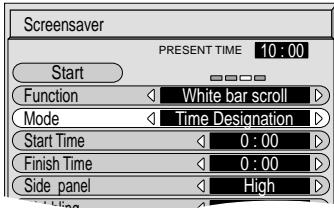

Press to select Start Time/ Finish Time
(When Time Designation is selected).
Press to select Periodic Time/ Operating Time
(When Interval is selected).

Press to setup.
▶ button: Forward
◀ button: Back

Notes:

- Pressing "◀" or "▶" button once changes the Time 1minutes.
[However, switching occurs every 15 minutes when Periodic Time is selected.]
- Pressing "◀" or "▶" button continuously changes the Time by 15 minutes.

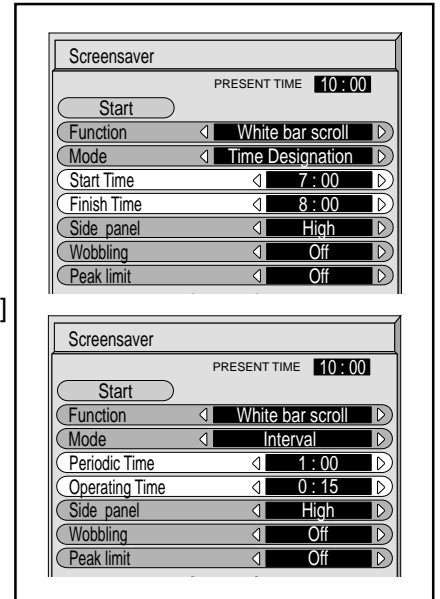
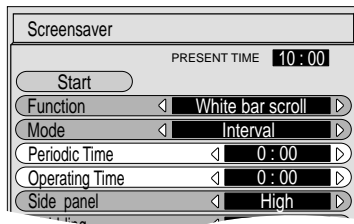
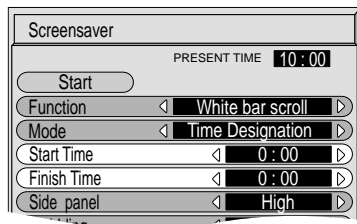

Note: Timer function will not work unless "PRESENT TIME" is set.

Reduces screen after-image

These functions prevent the occurrence of an "after image" on the display when turned ON.

Wobbling: Automatically shifts the display image at a dot level pitch (therefore unnoticeable to the eye) over time to prevent after image of sharper contour of image.

Peak Limit: Suppresses image contrast (peak brightness).

1



Press to display the Setup menu screen.

2

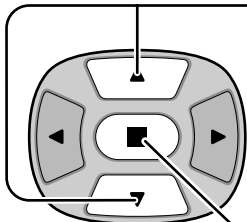

Press to select "Screensaver".

Press to display Screensaver menu.

3

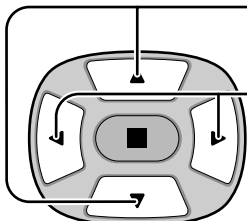

Press to select "Wobbling" or "Peak limit".

Press to select "On" or "Off".

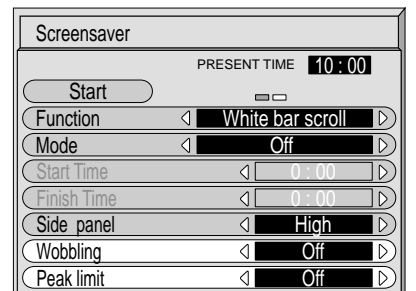
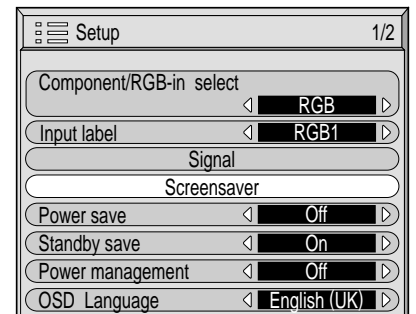

Side Panel Adjustment

Do not display a picture in 4:3 mode for an extended period, as this can cause an after-image to remain on the side panels either side of the display field.

To prevent the appearance of such an after-image, illuminate the side panels.

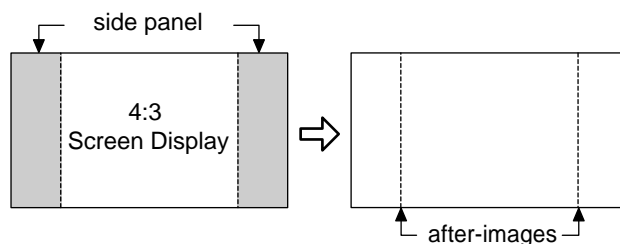

This function may be applicable to the non-picture area.

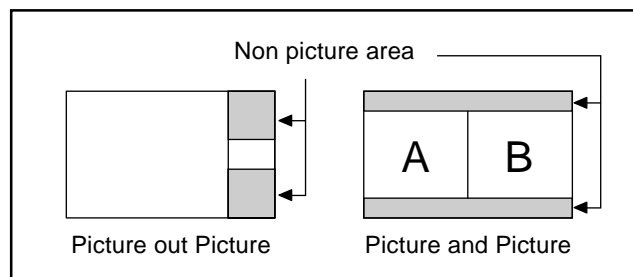

1 To display the Screensaver screen.
(Refer to the previous page, operation guide steps 1 and 2)

2

Press to select the Side panel.

Press to select Off, Low, Mid, High.

Off ↔ Low ↔ Mid ↔ High

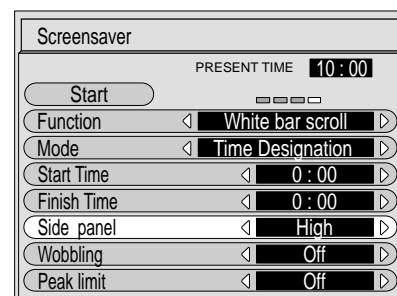

3

Press to exit from Screensaver.

Notes:

- Setting the side panel to High mode for an extended period may result in occurrence of after-images.
- The side panels may flash (alternate black/white) depending on the picture being shown on the screen. In such an occurrence, use the Cinema mode.

Reduces power consumption

- **Power save:** When this function is turned On, luminous level of the plasma display is suppressed, so power consumption is reduced.
- **Standby save:** When this function is turned On, power consumption of the microcomputer is reduced during power supply standby (see page 10, 11, 12), so standby power of the set is reduced.
- **Power management:** The unit power supply is turned On or Off depending on whether or not there is a signal during PC input mode. This function is enabled when it is turned On. (Only during input from PC (MiniD-sub) terminal)
- **Auto power off:** Equipment power supply is turned Off when there is no signal. When this is set to On, the power supply of the unit goes Off 10 minutes after the input signals stop. This function is effective for input signals except input from PC (Mini D-sub) terminal.

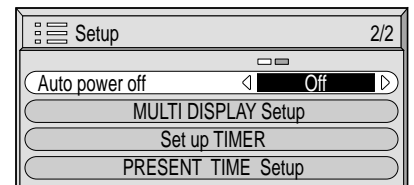
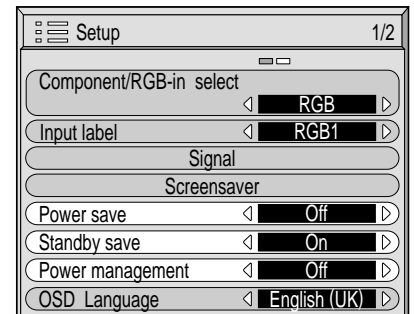
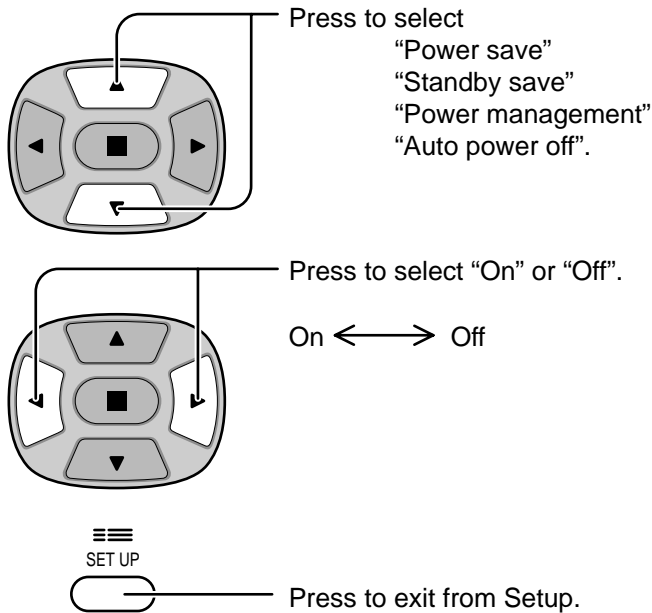

Note:

"Power management" and "Auto power off" are effective during normal viewing (one picture screen) only.

Customizing the Input labels

This function can change the label of the Input signal to be displayed.

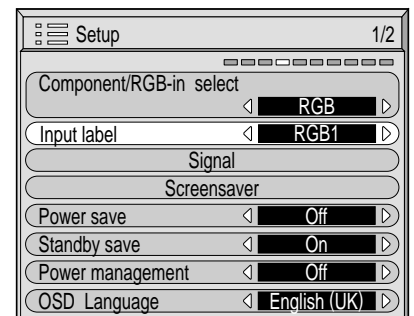
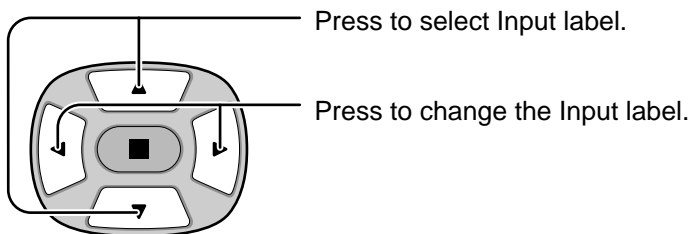

Notes:

While selecting an Input signal through Optional Terminal Board connected to Slot1 to Slot3, the Input label will depend on each Optional Terminal Board.

Input labels for Slot1 to Slot3 and miniD-sub:

- [Slot1 Input] INPUT1/VIDEO1/COMPONENT1/RGB1/RGB1(digital)/PC1/DVD1/CATV1/VCR1/STB1
- [Slot2 Input] INPUT2/VIDEO2/COMPONENT2/RGB2/RGB2(digital)/PC2/DVD2/CATV2/VCR2/STB2
- [Slot3 Input] INPUT3/VIDEO3/COMPONENT3/RGB3/PC3/DVD3/CATV3/VCR3/STB3
- [PC (MiniD-sub) input] PC/COMPONENT/RGB/DVD/STB

Setup for MULTI DISPLAY

- ① By lining up Plasma Displays in groups of 4 or 9 as illustrated below, an enlarged picture may be displayed across all screens.
- ② For this mode of operation, each plasma display has to be set up with a Display number to determine its location.

group of 4 (2x2)



group of 9 (3x3)



How to Setup MULTI DISPLAY

1



Press to display the Setup menu screen.

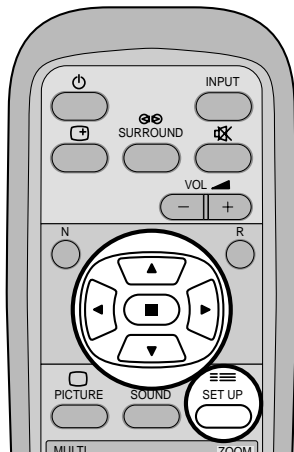

2

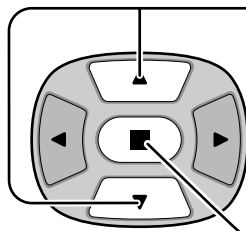

Press to select the MULTI DISPLAY Setup.

Press to display the "MULTI DISPLAY Setup" menu.

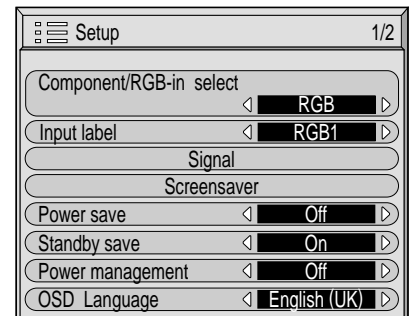

3

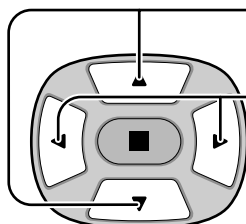

Press to select the MULTI DISPLAY Setup.

Press to select "On" or "Off".

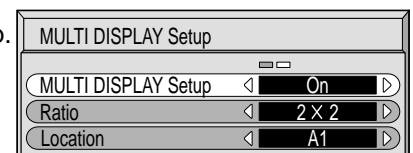
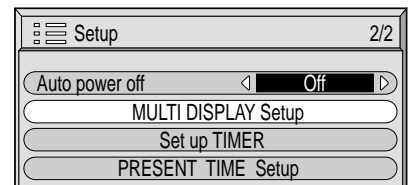

How to set the display location number for each Plasma Display

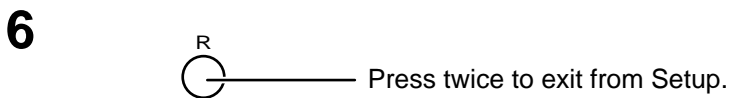
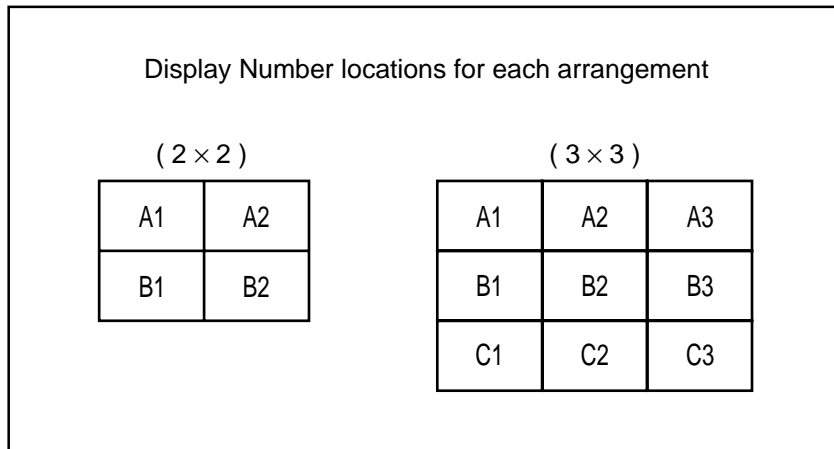
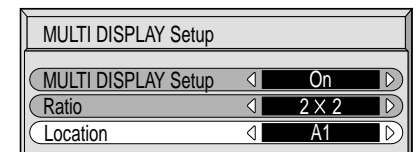
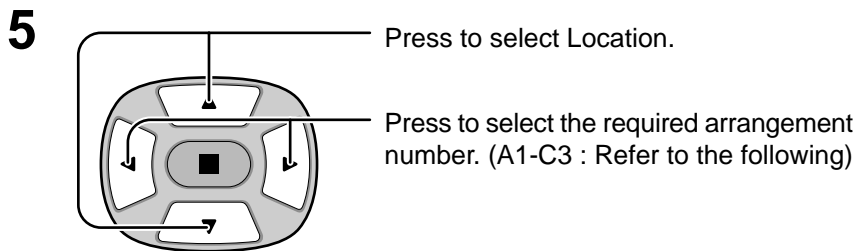
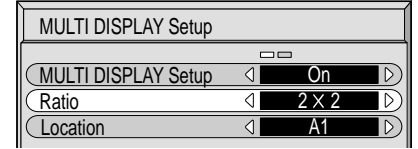
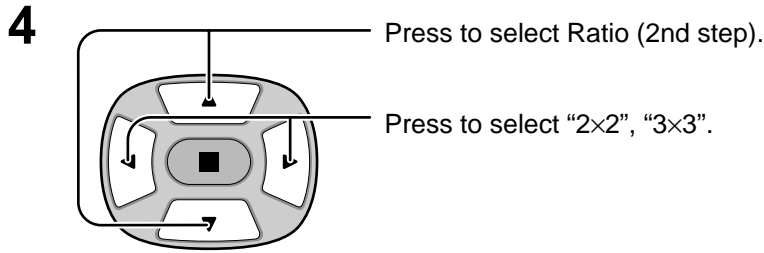

Notes:

- (1) For RGB/PC input signals, normal multi-display magnification is only available at the VGA, SVGA and XGA resolution.
- (2) The multi-display capability is functional for the following component signals:
525 (480) / 60i · 60p, 625 (575) / 50i · 50p, 1125 (1080) / 60i · 50i · 24sF, 750 (720) / 60p · 50p, 1250 (1080) / 50i
- (3) The multi-display capability is functional for the following composite signals:
NTSC, PAL, SECAM

Setup for Input Signals

Component/RGB-in Select

Select the input signals to be connected by installing the Optional Terminal Board.

(Refer to the Operating Instructions for the optional Terminal Board.)

Select to match the signals from the source connected to the Component/RGB input terminals.

Y, P_B, P_R signals ⇨ "Component"

R, G, B, HD, VD signals ⇨ "RGB"

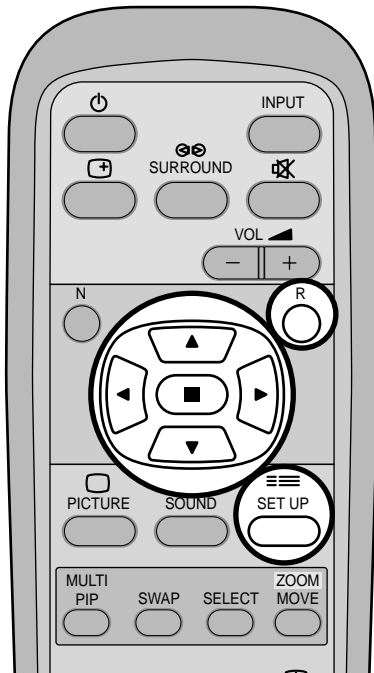

1



Press to display the Setup menu screen.

2

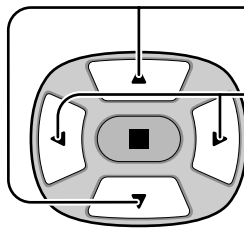

Press to select the "Component/RGB-in Select".

Press to select the desired input signal.

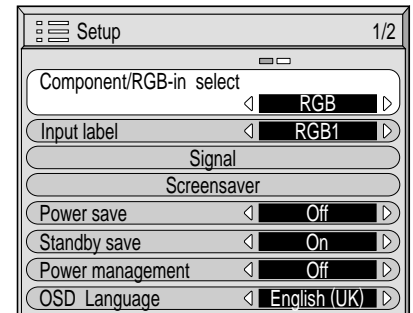

Component ↔ RGB



Press to exit from adjust mode.

Note:

Selection may not be possible, depending on which optional board is installed.

3D Y/C Filter – For NTSC AV images

Select "Signal" from the "Setup" menu during AV(S Video) input signal.

("Signal [AV]" menu is displayed.)

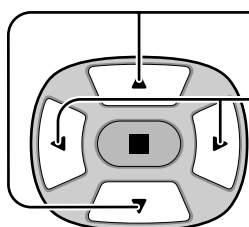

Press to select the "3D Y/C Filter (NTSC)".

Press to set On/Off.



Press to exit from adjust mode.

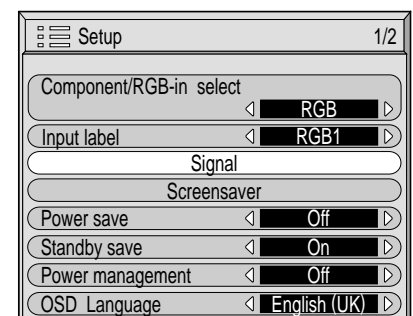

↓ Press (ACTION) button

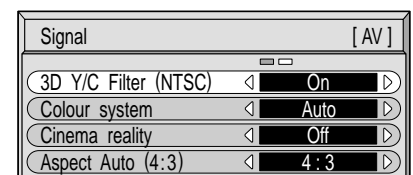

Note:

When On, this setting only affects NTSC input signals.

Colour system / Aspect Auto

Select Signal from the "Setup" menu during AV(S Video) input signal. ("Signal [AV]" menu is displayed.)

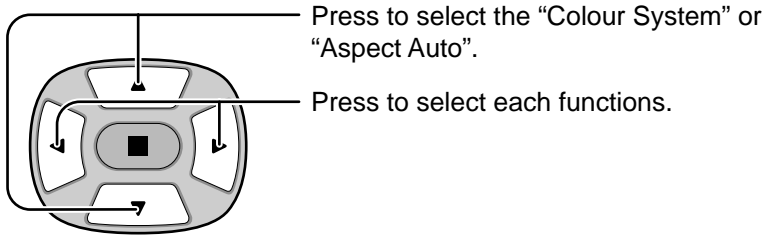

If the picture image becomes unstable:
With the system set on Auto, under conditions of low level or noisy input signals the image may in rare cases become unstable. Should this occur, set the system to match the format of the input signal.

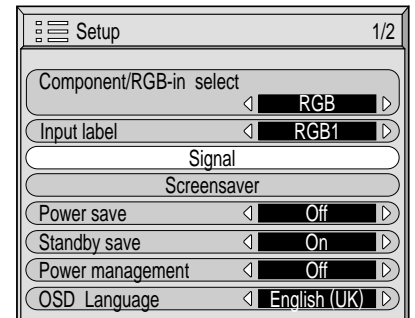

Press (ACTION) button

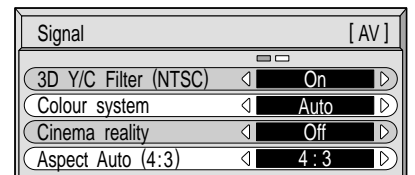

Mode	Function
Colour system	Set the colour system to match that of the input signal. If set to "Auto", the colour system is automatically selected from "PAL", "SECAM" and "NTSC", but not from "M-NTSC". To view M-NTSC format pictures, you must manually set to "M-NTSC". <div style="text-align: center;"> > Auto <-> PAL <-> SECAM <-> M.NTSC <-> NTSC < </div>
Aspect Auto (4:3)	Set to "4 : 3" to view 4:3 images in an unchanged format when Aspect Auto is selected. If you would like to view 4:3 images in Just format, set to "Just".

Cinema reality

When on, the display attempts to reproduce a more natural interpretation of sources such as movie pictures, which are recorded at 24 frames per second.

If the picture is not stable, turn the setting to off.

Select "Signal" from the "Setup" menu during AV(S Video) or Component input signal. ("Signal [AV]" or "Signal [Component]" menu is displayed.)

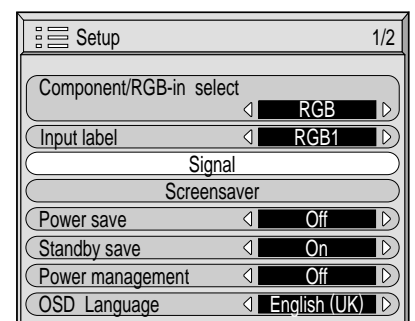
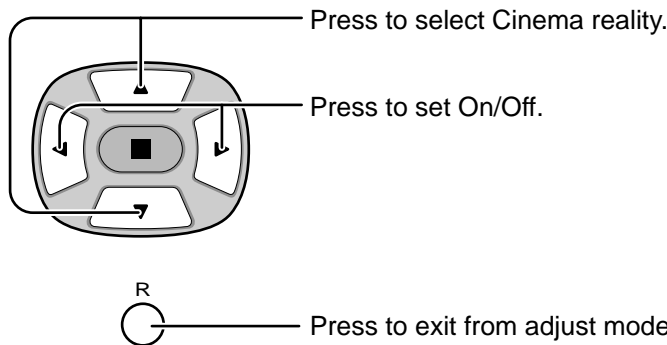

Press (ACTION) button

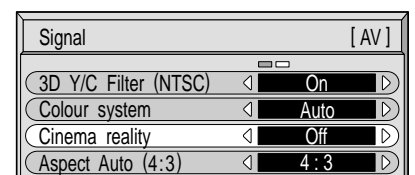

Note:

When On, this setting only affects the following signal input:

- NTSC / PAL signal input during "AV(S Video)" input signal.
- 525i(480i) 625i(575i) signal input during "Component" input signal.

Sync

Select Signal from the "Setup" menu during RGB input signal.

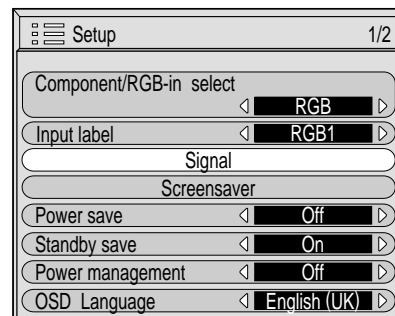
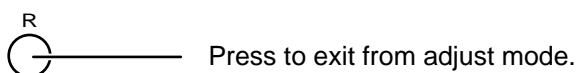
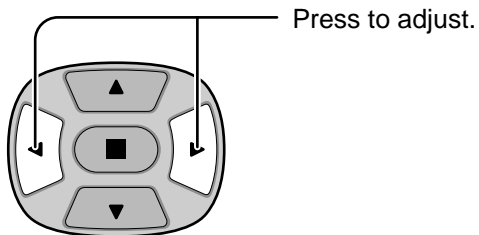

↓ Press (ACTION) button

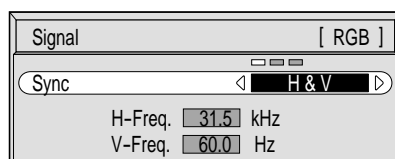

Setting RGB sync signal:

Confirm that the input is set to RGB input (this setting is valid only for RGB input signal).

- H & V: The H and V sync signals are input from the HD/VD connector.
- on G: Uses a synchronized signal on the Video G signal, which is input from the G connector.
- CS: Uses a synchronized signal of Composite Sync input.

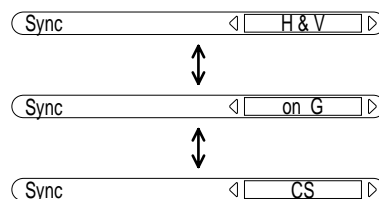

H-Freq. (kHz)/V-Freq. (Hz)

Displays the H (Horizontal)/V (Vertical) frequencies.

This display is valid only for RGB input and PC input signal.





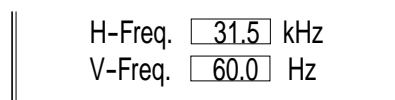

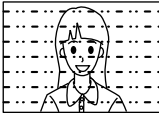

Display range:

- Horizontal 15 - 110 kHz
- Vertical 48 - 120 Hz

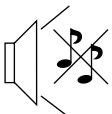

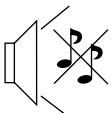
Troubleshooting

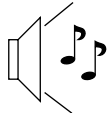
Before you call for service, determine the symptoms and make a few simple checks as shown below.

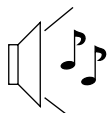
Symptoms		Checks
Picture	Sound	
 <p>Interference</p>	 <p>Noisy Sound</p>	Electrical Appliances Cars/Motorcycles Fluorescent light
 <p>Normal Picture</p>	 <p>No Sound</p>	Volume (Check whether the mute function has been activated on the remote control.)
 <p>No Picture</p>	 <p>No Sound</p>	Not plugged into AC outlet Not switched on Picture and Brightness/Volume setting (Check by pressing the power switch or stand-by button on the remote control.)
 <p>No Picture</p>	 <p>Normal Sound</p>	If a signal with a non-applicable colour system format, or frequency is input, only the input terminal indication is displayed.
 <p>No Colour</p>	 <p>Normal Sound</p>	Colour controls set at minimum level (see page 18, 19) Colour system (see page 31)

This Plasma Display uses special image processing. Hence a slight time lag may occur between image and audio, depending on the type of input signal. However, this is not a malfunction.

Plasma Display panel

Symptoms	Check
Some parts of the screen do not light up.	The plasma display panel is manufactured using an extremely high level of precision technology, however, sometimes some parts of the screen may be missing picture elements or have luminous spots. This is not a malfunction.
 <p>After-images appear</p>	Do not allow a still picture to be displayed for an extended period, as this can cause a permanent after-image to remain on the Plasma Display. Examples of still pictures include logos, video games, computer images, teletext and images displayed in 4:3 mode. Note: The permanent after-image on the Plasma Display resulting from fixed image use is not an operating defect and as such is not covered by the Warranty. This product is not designed to display fixed images for extended periods of time.
Whirring sounds can be heard from the display unit.	The display unit is fitted with a cooling fan to dissipate heat generated during normal use. The whirring sound is caused by rotation of the fan and is not a malfunction.

Input signal can be displayed

Applicable input signals for PC Input (Mini D-sub 15P) (* Mark)

	Signal name	Horizontal frequency (kHz)	Vertical frequency (Hz)	Component	RGB	When Multi Screen and Digital Zoom
1	525 (480) / 60i	15.73	59.94	*	*	*
2	525 (480) / 60p	31.47	59.94	*	*	*
3	625 (575) / 50i	15.63	50.00	*	*	*
4	625 (575) / 50p	31.25	50.00	*	*	*
5	750 (720) / 60p	45.00	60.00	*	*	*
6	750 (720) / 50p	37.50	50.00	*	*	*
7	1,125 (1,080) / 60i	33.75	59.94	*	*	*
8	1,125 (1,080) / 50i	28.13	50.00	*	*	*
9	1,125 (1,080) / 24p	27.00	24.00	*	*	
10	1,125 (1,080) / 24sF	27.00	48.00	*	*	*
11	1,250 (1,080) / 50i	31.25	50.00	*	*	*
12	640 × 400 @70 Hz	31.47	70.00		*	*
13	640 × 480 @60 Hz	31.47	59.94		*	*
14	Macintosh13" (640 × 480)	35.00	66.67		*	*
15	640 × 480 @75 Hz	37.50	75.00		*	*
16	800 × 600 @60 Hz	37.88	60.32		*	*
17	800 × 600 @75 Hz	46.88	75.00		*	*
18	800 × 600 @85 Hz	53.67	85.06		*	*
19	Macintosh16" (832 × 624)	49.73	74.55		*	*
20	1,024 × 768 @60 Hz	48.36	60.00		*	*
21	1,024 × 768 @70 Hz	56.48	70.07		*	*
22	1,024 × 768 @75 Hz	60.02	75.03		*	*
23	1,024 × 768 @85 Hz	68.68	85.00		*	*
24	Macintosh21" (1,152 × 870)	68.68	75.06		*	
25	1,280 × 1,024 @60 Hz	63.98	60.02		*	
26	1,280 × 1,024 @75 Hz	79.98	75.03		*	
27	1,280 × 1,024 @85 Hz	91.15	85.02		*	
28	1,600 × 1,200 @60 Hz	75.00	60.00		*	

Note:

Signals without above specification may not be displayed properly.

Specifications

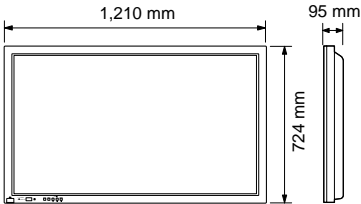
GD-V502PCE	
Power Source	220 - 240 V AC, 50Hz/60 Hz
Power Consumption	
Normal use	445 W
Stand-by condition	Save off 1.9 W, Save on 1.1 W
Power off condition	0.4 W
Plasma Display panel	Drive method : AC type 50-inch, 16:9 aspect ratio
Contrast Ratio	3000:1
Screen size	1,106 mm (W) × 622 mm (H) × 1,269 mm (diagonal)
(No.of pixels)	1,049,088 (1,366 (W) × 768 (H)) [4,098 × 768 dots]
Operating condition	
Temperatuer	0 °C - 40 °C
Humidity	20 % - 80 %
Applicable signals	
Colour System	NTSC, PAL, PAL60, SECAM, Modified NTSC
Scanning format	525 (480) / 60i · 60p, 625 (575) / 50i · 50p, 750 (720) / 60p · 50p, 1125 (1080) / 60i · 50i · 24p · 24sF SMPTE274M, 1250 (1080) / 50i
PC signals	XGA display VGA, SVGA, XGA SXGA, UXGA (compressed) Horizontal scanning frequency 15 - 110 kHz Vertical scanning frequency 48 - 120 Hz
Connection terminals	
PC	(HIGH-DENSITY MINI D-SUB 15PIN) R,G,B/0.7 Vp-p (75-ohm) Component Y : 1.0 Vp-p (75-ohm : include sync) P _B /C _B : ± 0.35 Vp-p (75-ohm) P _R /C _R : ± 0.35 Vp-p (75-ohm) HD, VD/1.0 - 5.0 Vp-p (high impedance) AUDIO IN (M3 JACK) 0.5 Vrms (high impedance)
SERIAL	EXTERNAL CONTROL TERMINAL (D-SUB 9PIN) RS-232C COMPATIBLE
SPEAKERS (6 Ω)	16W [8 W + 8 W] (10 % THD)
Accessories Supplied	
Remote Control Transmitter	EUR646532
Batteries	2 × R6 Size
Fixing bands	(TMME203 or TMME 187) × 2
Ferrite core	Small size × 1, Large size × 2
Dimensions (W × H × D)	1,210 mm × 724mm × 95mm 
Mass (weight)	
main unit only	approx. 43.5 kg net
with speakers	approx. 48.1 kg

Notes:

- (1) Design and specifications are subject to change without notice. Mass and dimensions shown are approximate.
- (2) This equipment complies with the EMC standards listed below.
EN55022, EN61000-3-2, EN61000-3-3, EN61000-6-2.



VICTOR COMPANY OF JAPAN, LIMITED

