

JVC

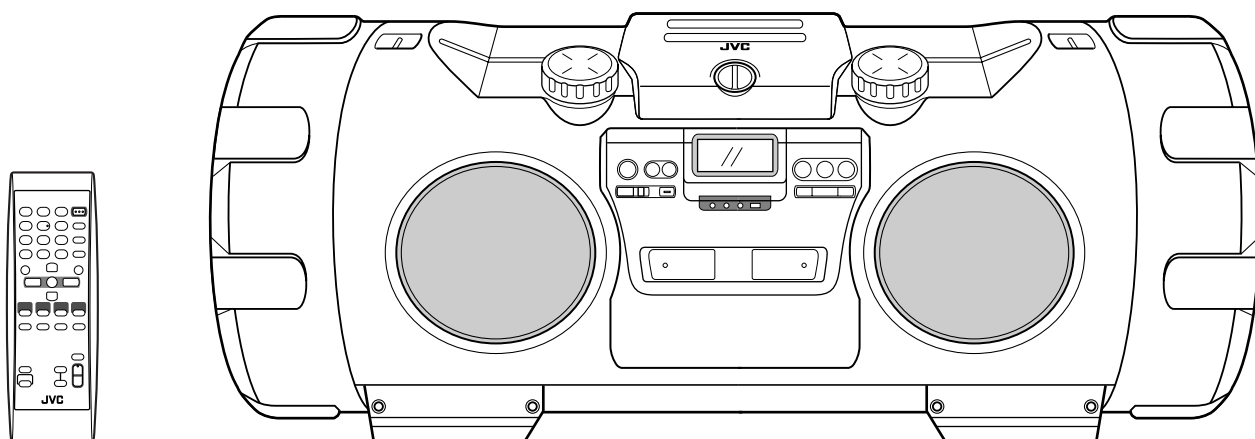

POWERED WOOFER CD SYSTEM

RV-NB20B/RV-NB20W



MP3
PLAYBACK

COMPACT
disc
DIGITAL AUDIO



INSTRUCTIONS

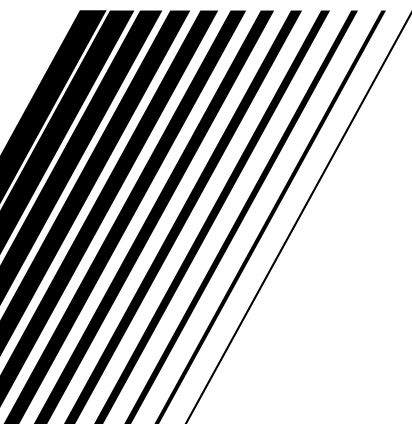

Warnings, Cautions and Others

IMPORTANT for the U.K.

DO NOT cut off the mains plug from this equipment. If the plug fitted is not suitable for the power points in your home or the cable is too short to reach a power point, then obtain an appropriate safety approved extension lead or consult your dealer.

BE SURE to replace the fuse only with an identical approved type, as originally fitted.

If nonetheless the mains plug is cut off ensure to remove the fuse and dispose of the plug immediately, to avoid a possible shock hazard by inadvertent connection to the mains supply.

If this product is not supplied fitted with a mains plug then follow the instructions given below:

IMPORTANT:

DO NOT make any connection to the terminal which is marked with the letter E or by the safety earth symbol or coloured green or green-and-yellow.

The wires in the mains lead on this product are coloured in accordance with the following code:

Blue: Neutral
Brown: Live

As these colours may not correspond with the coloured markings identifying the terminals in your plug proceed as follows:

The wire which is coloured blue must be connected to the terminal which is marked with the letter N or coloured black.

The wire which is coloured brown must be connected to the terminal which is marked with the letter L or coloured red.

IF IN DOUBT - CONSULT A COMPETENT ELECTRICIAN.

CAUTION— ON/STANDBY button!

Disconnect the mains plug to shut the power off completely (the STANDBY lamp goes off). When installing the apparatus, ensure that the plug is easily accessible. The  ON/STANDBY button in any position does not disconnect the mains line.

- When the unit is on standby, the STANDBY lamp lights red.
- When the unit is turned on, the STANDBY lamp goes off.

The power can be remote controlled.

CAUTION

To reduce the risk of electrical shocks, fire, etc.:

1. Do not remove screws, covers or cabinet.
2. Do not expose this appliance to rain or moisture.

Caution: Proper Ventilation

To avoid risk of electric shock and fire, and to prevent damage, locate the apparatus as follow:

1 Front:

No obstructions and open spacing.

2 Sides/ Top/ Back:

No obstructions should be placed in the areas shown by the dimensions below.

3 Bottom:

Place on the level surface. Maintain an adequate air path for ventilation by placing on a stand with a height of 10 cm or more.

Front View

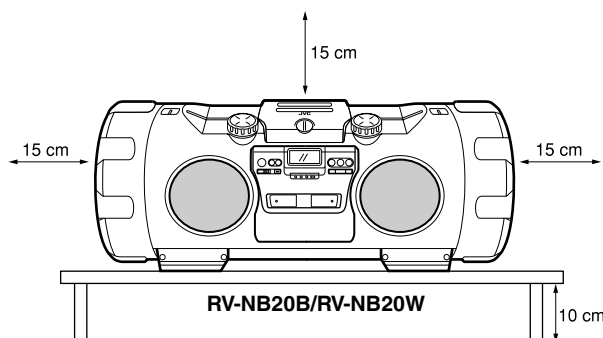

Side View

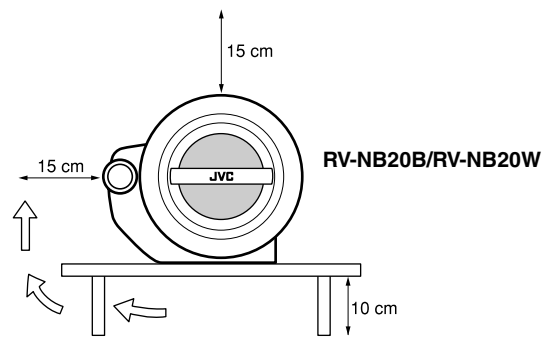

IMPORTANT FOR LASER PRODUCTS

1. CLASS 1 LASER PRODUCT

2. **CAUTION:** Do not open the top cover. There are no user serviceable parts inside the unit; leave all servicing to qualified service personnel.

3. **CAUTION:** Visible and/or invisible class 1M laser radiation when open. Do not view directly with optical instruments.

4. REPRODUCTION OF LABEL: CAUTION LABEL, PLACED INSIDE THE UNIT.

CAUTION VISIBLE AND/OR INVISIBLE CLASS 1M LASER RADIATION WHEN OPEN. DO NOT VIEW DIRECTLY WITH OPTICAL INSTRUMENTS. IEC60825-1:2001 (ENG)	ATTENTION RAYONNEMENT LASER VISIBLE ET/OU INVISIBLE DE CLASSE 1M UNE FOIS OUVERT. NE PAS REGARDER DIRECTEMENT AVEC DES INSTRUMENTS OPTIQUES. (FRA)	AVISO RADIACION LASER DE CLASE 1M VISIBLE Y/O INVISIBLE CUANDO ESTA ABIERTO. NO MIRAR DIRECTAMENTE CON INSTRUMENTAL OPTICO. (ESP)	VARNING SYNLIG OCH/ELLER OSYNLIG LASERSTRÅLNING. KLASS 1M, NÅR DENNA DEL ÄR ÖPPNAD. RETRAKTA EJA STRÅLEN MED OPTISKA INSTRUMENT. (SWE)	注意 ここを開くと有害 及び/または不可視 のクラス1M レーザー放射が 出ます。 光学顕微鏡で直接 見ないでください。 (JPN)	CAUTION VISIBLE AND/OR INVISIBLE CLASS I LASER RADIATION WHEN OPEN. DO NOT STARE INTO BEAM. FDA 21 CFR (ENG) LV44603-003A
--	--	---	--	---	--

CAUTION:

- Do not block the ventilation openings or holes. (If the ventilation openings or holes are blocked by a newspaper or cloth, etc., the heat may not be able to get out.)
- Do not place any naked flame sources, such as lighted candles, on the apparatus.
- When discarding batteries, environmental problems must be considered and local rules or laws governing the disposal of these batteries must be followed strictly.
- Do not expose this apparatus to rain, moisture, dripping or splashing and that no objects filled with liquids, such as vases, shall be placed on the apparatus.

Dear Customer,

This apparatus is in conformance with the valid European directives and standards regarding electromagnetic compatibility and electrical safety.

European representative of Victor Company of Japan, Limited is:
JVC Technology Centre Europe GmbH
Postfach 10 05 52
61145 Friedberg
Germany

SAFETY INSTRUCTIONS

“SOME DOS AND DON'TS ON THE SAFE USE OF EQUIPMENT”

This equipment has been designed and manufactured to meet international safety standards but, like any electrical equipment, care must be taken if you are to obtain the best results and safety is to be assured.

Do read the operating instructions before you attempt to use the equipment.

Do ensure that all electrical connections (including the mains plug, extension leads and interconnections between pieces of equipment) are properly made in accordance with the manufacturer's instructions. Switch off and withdraw the mains plug when making or changing connections.

Do consult your dealer if you are ever in doubt about the installation, operation or safety of your equipment.

Do be careful with glass panels or doors on equipment.

DON'T continue to operate the equipment if you are in any doubt about it working normally, or if it is damaged in any way—switch off, withdraw the mains plug and consult your dealer.

DON'T remove any fixed cover as this may expose dangerous voltages.

DON'T leave equipment switched on when it is unattended unless it is specifically stated that it is designed for unattended operation or has standby mode.

Switch off using the switch on the equipment and make sure that your family know how to do this.

Special arrangements may need to be made for infirm or handicapped people.

DON'T use equipment such as personal stereos or radios so that you are distracted from the requirements of traffic safety. It is illegal to watch television whilst driving.

DON'T listen to headphones at high volume as such use can permanently damage your hearing.

DON'T obstruct the ventilation of the equipment, for example with curtains or soft furnishings.

Overheating will cause damage and shorten the life of the equipment.

DON'T use makeshift stands and NEVER fix legs with wood screws—to ensure complete safety always fit the manufacturer's approved stand or legs with the fixings provided according to the instructions.

DON'T allow electrical equipment to be exposed to rain or moisture.

ABOVE ALL

— NEVER let anyone, especially children, push anything into holes, slots or any other opening in the case—this could result in a fatal electrical shock.

— NEVER guess or take chances with electrical equipment of any kind—it is better to be safe than sorry!

Information for Users on Disposal of Old Equipment

[European union]

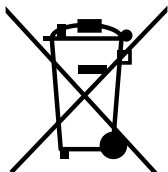

This symbol indicates that the electrical and electronic equipment should not be disposed of as general household waste at its end-of-life. Instead, the product should be handed over to the applicable collection point for the recycling of electrical and electronic equipment for proper treatment, recovery and recycling in accordance with your national legislation.

By disposing of this product correctly, you will help to conserve natural resources and will help prevent potential negative effects on the environment and human health which could otherwise be caused by inappropriate waste handling of this product. For more information about collection point and recycling of this product, please contact your local municipal office, your household waste disposal service or the shop where you purchased the product.

Penalties may be applicable for incorrect disposal of this waste, in accordance with national legislation.

Attention:

This symbol is only valid in the European Union.

(Business users)

If you wish to dispose of this product, please visit our web page www.jvc-europe.com to obtain information about the take-back of the product.

[Other Countries outside the European Union]

If you wish to dispose of this product, please do so in accordance with applicable national legislation or other rules in your country for the treatment of old electrical and electronic equipment.

Thank you for purchasing the JVC Powered Woofer CD System.

Before operating this system, read this manual carefully and thoroughly to obtain the best possible performance from your system, and retain this manual for future reference.

Features

Here are some of the things that make your system both powerful and simple to use.

- **General**
 - With JVC's **COMPU PLAY** you can turn on the system and start playing the iPod connected to the iPod jack with a single touch, as well as the radio and disc player. (Only when AC power is used.)
 - Shoulder strap with carrying case for the iPod and carrying handle
 - Active Clear Sound (ACS) circuit for enhancing sound reproduction
 - Super woofer volume control that provides powerful bass
 - Sound mode control—reproducing various sound fields
 - Remote control unit that operates the disc, tuner, and iPod functions
 - Locking mechanism for disc door
 - Microphone/guitar input
- With Quick Portable Link (QP Link) function, the system automatically switches the source to AUX when the connected auxiliary equipment starts to play.
- Disc playback mode includes Skip Play, Search Play, Repeat Play, Random Play, and Program Play.
- A 45-station preset capability (30 stations in FM band and 15 stations in AM band) in addition to auto-seek and manual tuning.
- Clock/timer functions, timer on/off with preset volume function, and sleep timer.



iPod is a trademark of Apple Computer, Inc., registered in the U.S. and other countries.

IMPORTANT CAUTIONS

1. Where to place the system

- Select a place which is level, dry and neither too hot nor too cold (between 5°C and 35°C).
- Leave sufficient distance between the system and a TV.
- Do not use the system in a place subject to vibrations.

2. Power cord

- Do not handle the power cord with wet hands!
- Some power is always consumed as long as the power cord is connected to the wall outlet.
- When unplugging the system from the wall outlet, always pull the plug, not the power cord.

3. When carrying the system

- Remove a disc from the system.
- Disconnect all the cords from the system.

4. Malfunctions, etc.

- There are no user serviceable parts inside. In case of system failure, unplug the power cord and consult your dealer.
- Do not insert any foreign object into the system.
- The system is not waterproof or dust proof.

Table of contents

Features	1	Listening to the iPod	13
IMPORTANT CAUTIONS	1	Listening to auxiliary equipment	14
Index of parts and controls	2	Using the microphone/guitar	15
Getting started	3	Using the timer	15
Basic operations	7	Care and maintenance	17
Listening to the radio	9	Troubleshooting	17
Playing back discs	10	Specifications	18

Index of parts and controls

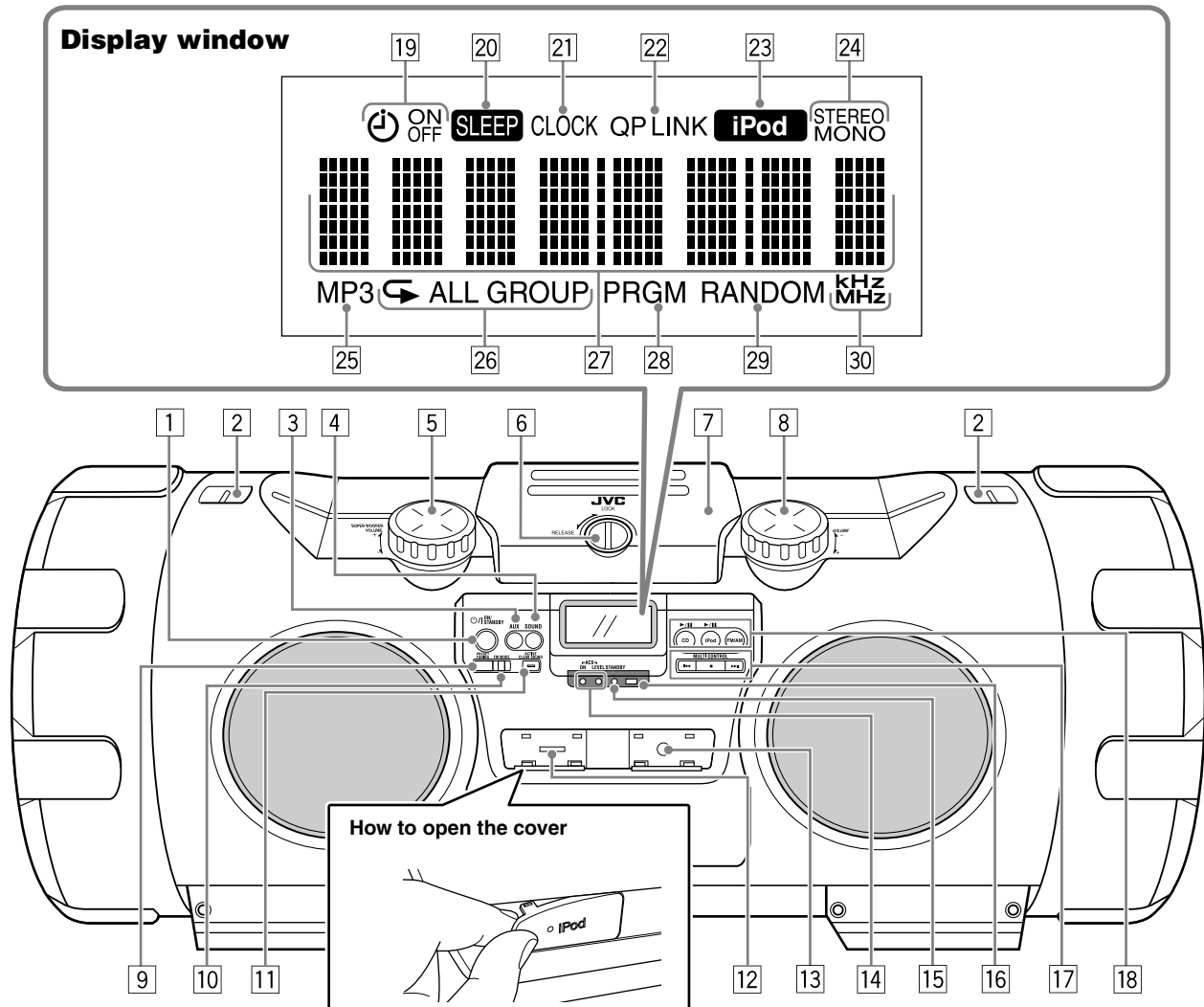

See pages in parentheses for details.

- 1 $\text{\textcircled{I}}$ /ION/STANDBY button (7)
- 2 Shoulder strap hooks (4)
- 3 AUX button (3, 14)
 - Pressing this button also turns on the system.
- 4 SOUND button (8)
- 5 SUPER WOOFER VOLUME +/- control knob (8)
- 6 LOCK/RELEASE knob (10)
- 7 Disc compartment door (10)
- 8 VOLUME +/- control knob (7)
- 9 PRESET TUNING button (9)
- 10 FM MODE button (9)
- 11 ACTIVE CLEAR SOUND button (8)
- 12 iPod jack (6)
- 13 AUX jack (6)
- 14 ACS (Active Clear Sound) indicators (8)
 - ON, LEVEL
- 15 STANDBY lamp (7)
- 16 Remote sensor (4)
- 17 MULTI CONTROL buttons (9 – 13)
 - \blacktriangleleft (reverse skip), \blacksquare , \blacktriangleright (forward skip)
- 18 Source and play mode buttons (3, 9 – 13)
 - CD \blacktriangleright /II, iPod \blacktriangleright /II, FM/AM
 - Pressing one of these buttons also turns on the system.

Display window

- 19 Timer indicators (16)
 - $\text{\textcircled{I}}$ (timer), ON, OFF
- 20 SLEEP indicator (15)
- 21 CLOCK indicator (8, 15)
- 22 QP LINK indicator (14)
- 23 iPod indicator (13)
- 24 FM mode indicators (9)
 - STEREO, MONO
- 25 MP3 indicator (11)
- 26 Repeat indicators (12)
 - $\text{\textcircled{C}}$, ALL, GROUP
- 27 Main display
- 28 PRGM (program) indicator (12)
- 29 RANDOM indicator (12)
- 30 Frequency unit indicators (8, 9)
 - kHz, MHz

Remote control

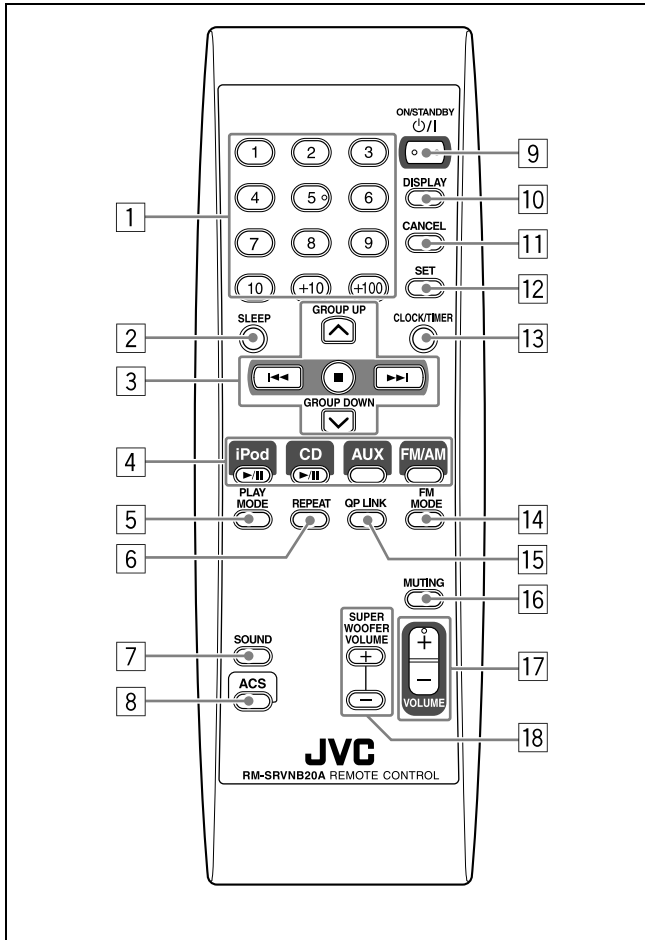

See pages in parentheses for details.

- 1 Number buttons (9, 11)
- 2 SLEEP button (15)
- 3 Multi control buttons (9, 11, 15, 16)
 - ^ GROUP UP, v GROUP DOWN
 - ◀◀, ■, ▶▶
- 4 Source buttons (3, 9 – 14)
 - iPod ▶/||, CD ▶/||, AUX, FM/AM
 Pressing one of these buttons also turns on the system.
- 5 PLAY MODE button (12)
- 6 REPEAT button (12)
- 7 SOUND button (8)
- 8 ACS (Active Clear Sound) button (8)
- 9 ON/STANDBY button (7, 15, 16)
- 10 DISPLAY button (8)
- 11 CANCEL button (12, 15, 16)
- 12 SET button (10, 15, 16)
- 13 CLOCK/TIMER button (15, 16)
- 14 FM MODE button (9)
- 15 QP LINK button (14)
- 16 MUTING button (8)
- 17 VOLUME +/- button (7)
- 18 SUPER WOOFER VOLUME +/- buttons (8)

COMPU PLAY — One Touch Operation

With One Touch Operation you can play a disc, an iPod, or turn on the radio with a single press of the play button for that function. The system turns on and starts playing the source if it is ready.

The COMPU PLAY buttons are: **On the system and remote control**

- iPod ▶/|| button
- CD ▶/|| button
- AUX button
- FM/AM button

Note: The COMPU PLAY feature is not effective when the system is operated on batteries or car battery (DC12V).

Getting started

Accessories

Check that you have all the following items, which are supplied for the system.

- Power cord (1)
- Remote control (1)
- Batteries—R6(SUM-3)/AA(15F) (2)
- Shoulder strap with carrying case for the iPod (1)
- iPod cable (1)
- iPod stand (1)

If any of these items are missing, contact your dealer immediately.

Carrying the system

■ Using the carrying handles

Be sure to hold both handles when you carry the system.

If you carry the system by only one handle, because of the length of the system, the end may drag on the ground and be damaged as a result.

Do not lift the system by the woofer ducts, and do not insert any foreign objects into them.

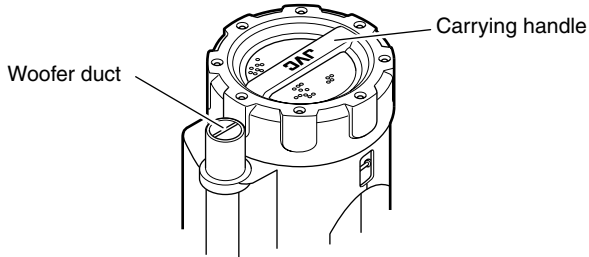

■ Using the shoulder strap

Attach the supplied shoulder strap (adjustable in length) to each end of the system as illustrated.

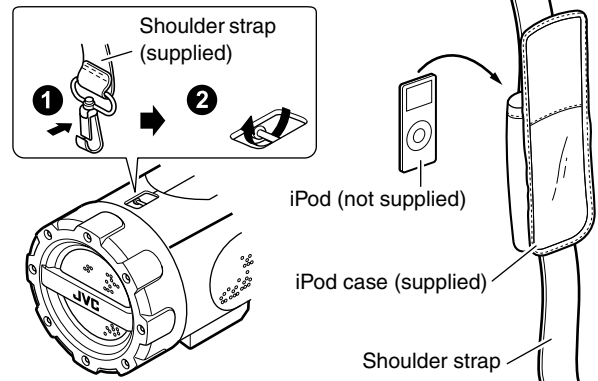

To detach the shoulder strap, press in the metal fitting and unhook it from the shaft.

Using the remote control — RM-SRVNB20A

■ Installing the batteries

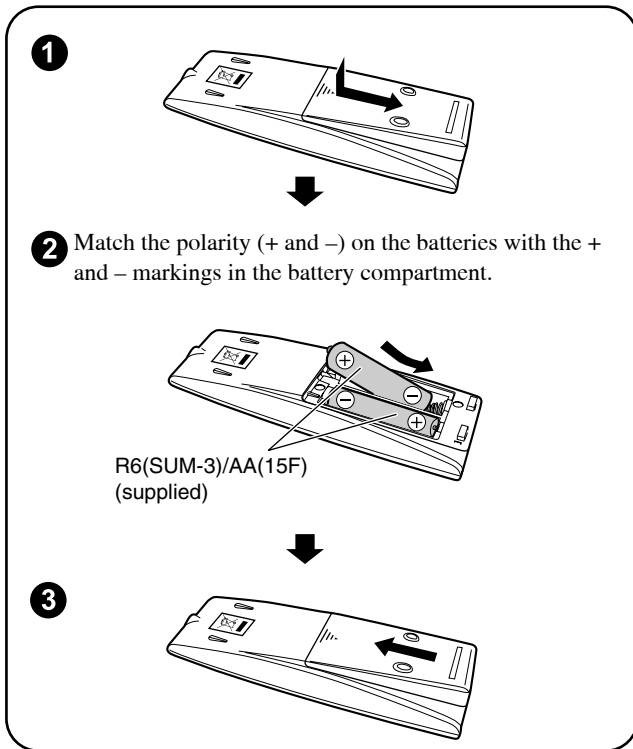

CAUTION:

To avoid battery leakage or explosion:

- Remove batteries when the remote control is not in use for an extended period of time.
- When you need to replace the batteries, replace both batteries at the same time with new ones.
- Do not use different types of batteries together.

Point the remote control at the remote sensor on the system's control panel (from a distance of up to 7 m). If you point the remote control from the slant direction, the distance will be shortened.

- Do not expose the remote sensor to strong direct sunlight or artificial lighting.
- Make sure there are no obstacles between the remote sensor and the remote control.

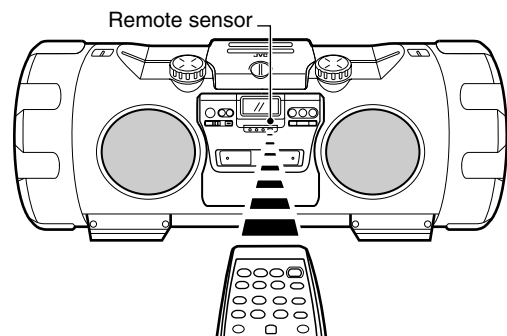

Checking the type of your iPod

This system has been designed to operate an iPod (see page 13).

Compatible iPod types:

iPod nano 1G/2G/4G
iPod mini
iPod (4th Generation) 20G/40G
iPod photo (4th Generation) 20G/30G/40G/60G
iPod video (5th Generation) 30G/60G

If the iPod does not play correctly, please update your iPod Software to the latest version.

- For details about updating your iPod, check on the Apple web site <<http://www.apple.com>>.

Connections

CAUTION: Make all connection before plugging the system into an AC power outlet.

■ **Connecting the microphone/guitar**
(See page 15.)

(Not supplied)

(Not supplied)

■ **Connecting the headphones** (See page 7.)

(Not supplied)

Stereo mini plug

■ **Connecting to the car battery**

Car adapter (not supplied)

② To car's cigarette lighter socket (DC12V)

①

CAUTIONS:

- Be sure to use the car adapter (not supplied) with the same polarity design as the one equipped with this system to prevent mishaps or damage.
- For safety, stop the car before performing operations.
- Be sure to start the engine when you use the car adapter; otherwise, the car battery will be exhausted.
- During transport, stabilize the system in a box, etc.
- To prevent malfunctions, do not leave the system in a car for a long time.
- If the power is supplied through the car battery, the display will be blank with the system turned off (at standby).

Unplug the AC power cord from the system to supply the power through the car battery; otherwise, the system does not work.

■ **Connecting the AC power cord**

Power cord

CAUTIONS:

- **ONLY USE THE JVC POWER CORD PROVIDED FOR THIS SYSTEM TO AVOID MALFUNCTION OR DAMAGE TO THE SYSTEM.**
- **BE SURE TO UNPLUG THE POWER CORD FROM THE OUTLET WHEN GOING OUT OR WHEN THE SYSTEM IS NOT IN USE FOR AN EXTENDED PERIOD OF TIME.**

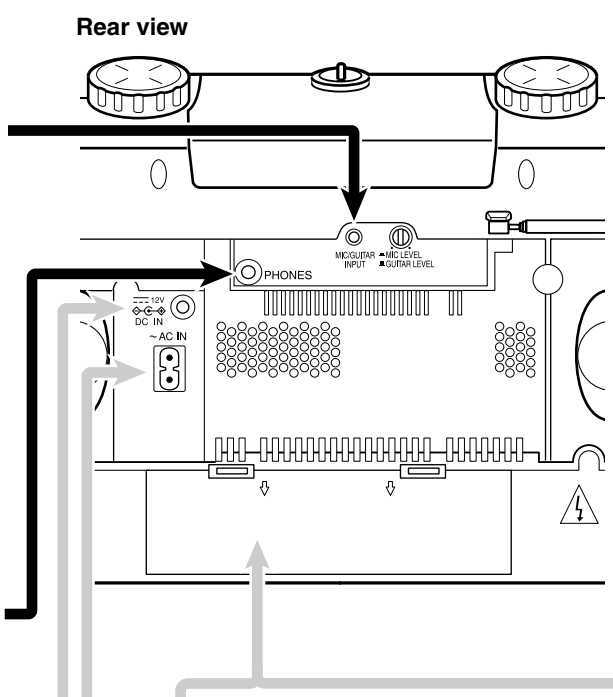

■ **Memory backup batteries**

- Battery cover
- Match the polarity (+ and -) on the batteries with the + and - markings in the battery compartment.

"R6(SUM-3)/AA(15F)" size batteries (not supplied)
-

■ Connecting the iPod (See page 13.)

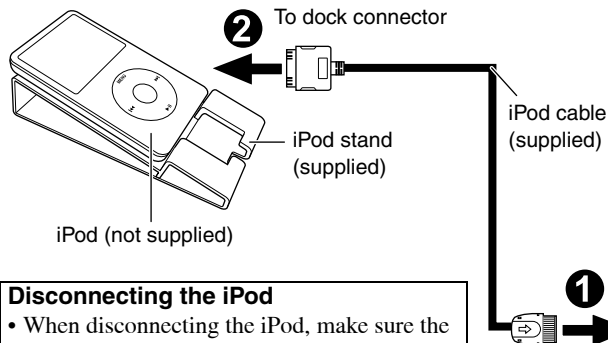

Disconnecting the iPod

- When disconnecting the iPod, make sure the system is turned off.
- To remove the iPod cable from the iPod, hold the buttons on the sides and pull.

■ Connecting the auxiliary equipment (See page 14.)

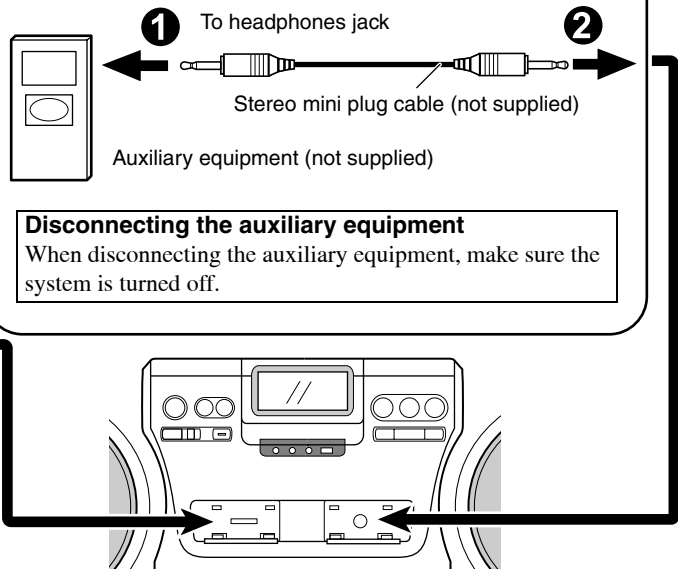

Disconnecting the auxiliary equipment

When disconnecting the auxiliary equipment, make sure the system is turned off.

Front view

To remove the batteries, remove battery “3” first.

Notes:

- The memory backup batteries will not be consumed as long as the power is supplied from an AC outlet, loaded 10 batteries, or car battery (DC12V). However, if no power is supplied to the system, the memory backup batteries should be replaced with new ones approximately every 12 months to securely maintain the contents of the memory.
- Before replacing the memory backup batteries, always connect the AC power cord to the system to prevent the contents of memory from being erased.
- When a power failure occurs, the time indication disappears from the display to save the battery power of the memory backup batteries.

CAUTION:

- To avoid battery leakage or explosion:
- When you need to replace the batteries, replace all batteries at the same time with new ones. Before replacing, you need to supply AC power to the system.
 - Do not use an old battery with new ones.
 - Do not use different types of batteries together.

■ Operating the system on batteries

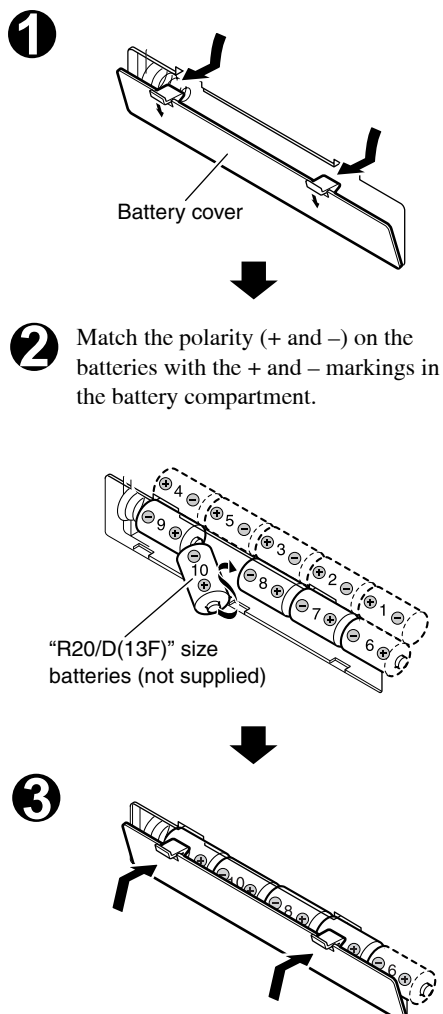

To remove the batteries, remove battery “10” first.

Notes:

- When you operate the system on mains (AC) power or on car battery (DC12V), the power source automatically switches from batteries to AC or DC12V. However, you should remove the 10 batteries when operating on AC power or car battery (DC12V).
- When the batteries are exhausted, the following symptoms will occur:
 - Mistracking occurs during disc playback.
 - “DC OFF” flashes on the display, then the power goes off.
 If this happens, replace the batteries.

CAUTION:

To avoid battery leakage or explosion:

- Remove the 10 batteries when the system is not in use for an extended period of time.
- When you need to replace the batteries, replace all batteries at the same time with new ones.
- Do not use different types of batteries together.
- If the power is supplied through the batteries, the display will be blank with the system turned off (at standby).

Unplug the AC power cord from the system to supply the power through the batteries; otherwise, the system does not work.

Basic operations

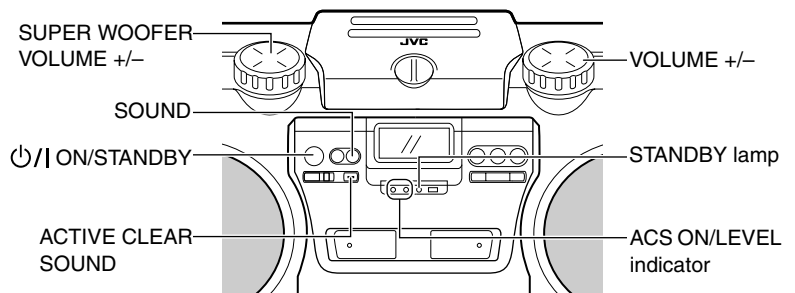
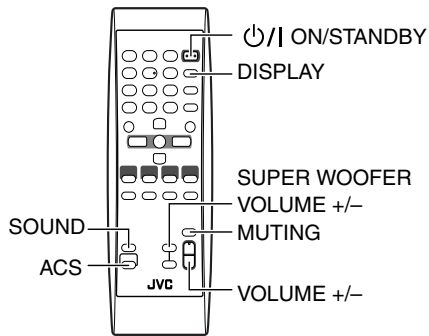

Turning the power on and off

Note: The lighting condition for the STANDBY lamp and for the display differs depending on the power source.

Power source	STANDBY lamp/display
<ul style="list-style-type: none"> AC power 	<ul style="list-style-type: none"> The STANDBY lamp lights when power is turned off. Backlighting of the display is illuminated when power is turned on.
<ul style="list-style-type: none"> Batteries or car battery (DC12V)* 	<ul style="list-style-type: none"> The STANDBY lamp does not light. Backlighting of the display is not illuminated. With the system turned off (at standby), no indication is shown on the display.

* If no source is playing and no operation is done for about 4 minutes, "DC OFF" starts flashing on the display for about one minute before the system turns off automatically (except when the source is FM/AM or AUX, or when the microphone/guitar is used).

Turning on the system

Press ON/STANDBY.

- When the system is operated on batteries or car battery (DC12V), press ON/STANDBY on the system. The STANDBY lamp goes off when the system is operated on AC power. The display comes on and the system is ready to continue in the mode it was in when the power was last turned off.

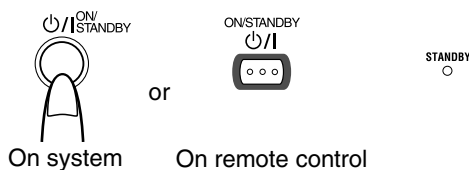

Turning off the system

Press ON/STANDBY again.

The STANDBY lamp lights up when the system is operated on AC power.

- When the AC power is used, the CLOCK indicator and the time are displayed without backlighting.

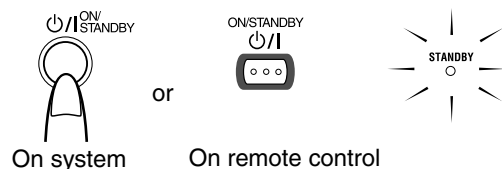

- Some power is always consumed even though power is turned off (called standby mode).
- To disconnect the system from mains (AC) supply completely, unplug the AC power cord from the AC outlet. When you unplug the AC power cord, the clock will be reset to "0:00" if no memory backup batteries are installed.

Adjusting the volume

You can adjust the volume level between 0 and 50.

Using the system

Turn the VOLUME +/- control clockwise to increase the volume or turn it counterclockwise to decrease the volume.

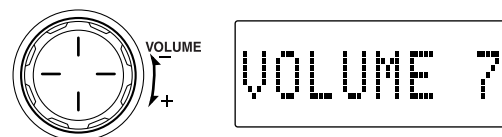

Using the remote control

Press VOLUME + to increase the volume or press VOLUME - to decrease it.

When you press and hold VOLUME + or -, the volume changes rapidly.

CAUTION:

DO NOT start playing any source without setting the volume to minimum first, as a sudden blast of sound can damage your hearing, speakers and/or headphones.

For private listening

Connect a pair of headphones to the PHONES jack on the rear of the system (see page 5). No sound comes out of the speakers. Be sure to turn down the volume before connecting or putting on the headphones.

Turning off the sound temporarily

Using the remote control only

Press **MUTING**.

“MUTING” appears on the display.



On remote control

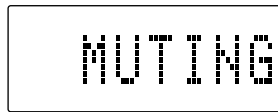

To restore the sound, press MUTING again or adjust the volume (see page 7).

Adjusting the super woofer volume

During play, you can adjust the bass level between BASS 1 (minimum) and BASS 6 (maximum).

Using the system

Turn the **SUPER WOOFER VOLUME +/-** control clockwise to increase the bass level or turn it counterclockwise to decrease the bass level.

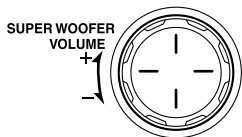

Using the remote control

Press **SUPER WOOFER VOLUME +** to increase the bass level or press **SUPER WOOFER VOLUME -** to decrease it.

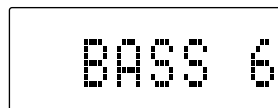
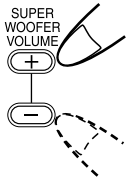

Note: This function is not effective when the headphones are in use.

Activating clear sound

The Active Clear Sound (ACS) circuit emphasizes high-frequency sound without lowering the signal-noise ratio, while adjusting its output according to the input signal level. This results in a better balance between the high-frequency sound and the low-frequency heavy bass.

Press **ACS (active clear sound)** to turn it on or off.

When it is turned on, the ACS ON indicator lights in red.



On system

or



On remote control

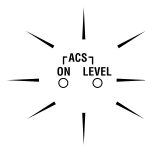

• The ACS LEVEL indicator flashes in green according to the input signal level.

Selecting the sound mode

Sound modes can be selected to enhance the type of music being played.

Press **SOUND** to select the sound mode.

Each time you press the button, the sound mode changes as follows:

FLAT → BEAT → POP → CLEAR

SOUND



On system

or



On remote control

Sound mode selection:

BEAT:

Set to this position for music with a heavy beat, such as rock and disco music.

POP:

Set to this position for light music including popular and vocal music.

CLEAR:

Set to this position for crisp and clear sounding music with transparent highs.

FLAT (no effect): Set to this position not to apply any sound mode.

Showing the time

While the power is turned on, you can see the current time (clock) at any time, as follows.

Using the remote control only

Press **DISPLAY**.

Each time you press the button, the display changes as follows:

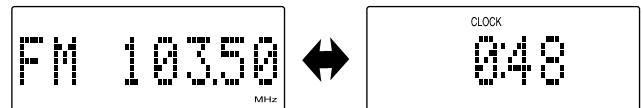

Current sound source (e.g. FM103.50 MHz) ↔ (clock)

Note: To let the clock work, you need to set the clock first. (See “Setting the clock” on page 15.)

Listening to the radio

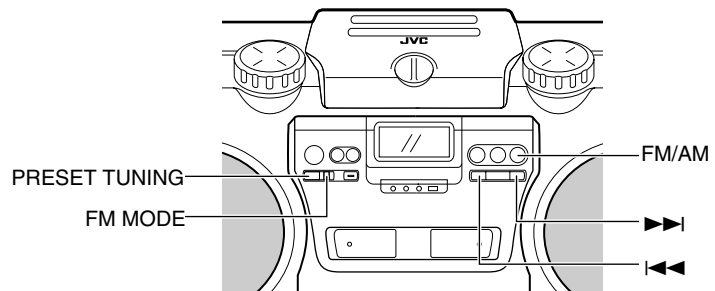
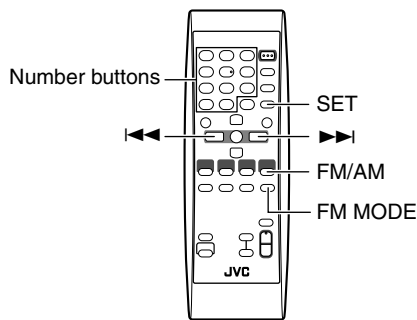

You can listen to FM and AM stations. Stations can be tuned in manually, automatically, or from preset memory storage.

■ Before listening to the radio, fully extend the FM telescopic antenna.

Tuning in to a station

1. Press FM/AM repeatedly to select either FM or AM.

Each time you press FM/AM, the band changes between FM and AM.

The system tunes in to the last tuned station. The following information appears on the display.

– When “Manual Tuning” or “Auto Tuning” was used to tune in to the last tuned station (see below), the band frequency appears.

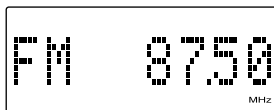

– When “Preset Tuning” was used to tune in to the last tuned station (see the right column), the preset number (displayed as “P-XX” on the display) and then the band frequency appear.

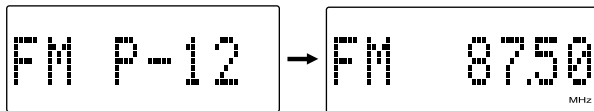

(After one second)

2. Select a station using one of the following methods.

• When you tune in to an FM stereo broadcast, the STEREO indicator lights up and you can hear stereo effect.

If an FM stereo broadcast is hard to receive or noisy, press FM MODE. The MONO indicator lights up and the sound becomes monaural, but the reception improves.

When you tune in to another station, the MONO indicator goes off and stereo effect restores automatically.

Note: AM broadcasts are monaural.

■ Manual Tuning

Press ◀◀ or ▶▶ repeatedly to move from frequency to frequency until you find the station you want.

OR

■ Auto Tuning

Press and hold ◀◀ or ▶▶ for one second or more.

The frequency changes automatically until a station frequency is found.

OR

■ Preset Tuning (possible only after presetting stations)

Select the desired preset number using PRESET TUNING on the system or the number buttons on the remote control. The preset number and then the band frequency appear on the display.

PRESET TUNING button: Each time you press the button, the preset number increases.

Number buttons: To select P-5, press 5.
To select P-15, press +10 then 5.
To select P-20, press +10 once then press 10.

Notice: To adjust the reception condition

For FM: Adjust the FM telescopic antenna’s length, angle and direction until the best reception is obtained.

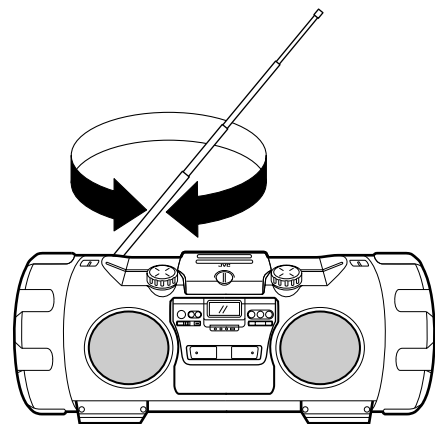

For AM: Change the direction of the system to obtain the best reception.

Placing the system near the window, for example, will improve AM reception.

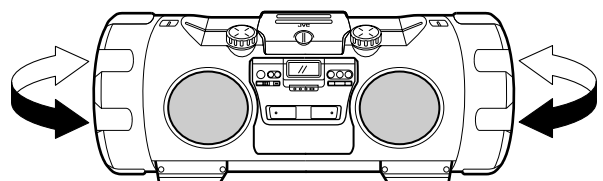

Presetting stations

You can preset up to 30 FM stations and 15 AM stations.

Note: Preset numbers may have been set to factory test frequencies prior to shipment. This is not a malfunction. You can preset the stations you want into memory as follows:

Using the remote control only

There is a time limit in doing the following steps. If the setting is canceled before you finish, start again from step 3.

1. Press **FM/AM** repeatedly to select either **FM** or **AM**.
2. Press **◀◀** or **▶▶** to tune in to a station.
3. Press **SET**.

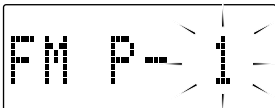

4. Press the number buttons to select the preset number you want.

- To select 5, press 5.
- To select 15, press +10 then 5.
- To select 20, press +10 once then press 10.

5. Press **SET**.

“STORED” appears on the display and the station is stored.

6. Repeat above steps 1. to 5. for each station you want to store into memory with a preset number.

To change the preset stations, repeat the same steps as above to overwrite a new station.

CAUTION:

To prevent the preset stations from being erased because of a power failure, etc., install memory backup batteries in the system. (See pages 5 and 6.)

Playing back discs

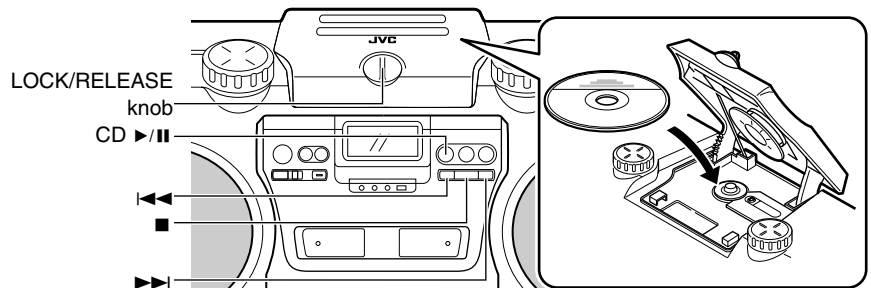
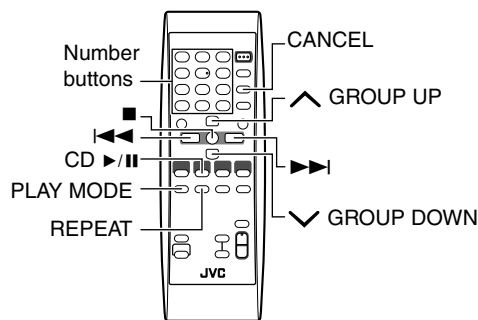

This system has been designed to play back the following discs—CD, finalized CD-R/CD-RW (recorded in audio CD format) and CD-R/CD-RW (in MP3 format).

- This system is not compatible with the other discs such as DVD, DVD-R, and DVD-RW.

Notes on MP3:

- The system can only recognize files (tracks) with “MP3” or “mp3” as the extensions, which can be in any combination of upper and lower case.
- It is recommended that you record your material at a 44.1 kHz sampling rate, using the 128 kbps data transfer rate.
- You can play back the discs containing the tracks in music CD format or MP3 files in ISO 9660 format.
- Some MP3 tracks or discs may not be played back because of their characteristics or recording conditions.
- MP3 discs require a longer readout time than normal discs.

- This system recognizes up to 999 tracks on a disc (or less depending on the recording condition of a disc).

Setting a disc

1. Turn the **LOCK/RELEASE** knob counterclockwise to open the disc compartment door.

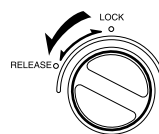

2. Place a disc, with its label side up as shown above.

3. Close the disc compartment door and turn the knob to “**LOCK**” position.

To remove the disc, open the disc compartment door in stop mode.

- You can place an 8 cm disc without an adapter.
- If the disc cannot be read correctly (because it is scratched, for example), “NO PLAY” or “NO DISC” appears on the display.
- You can place a disc while listening to the other source.

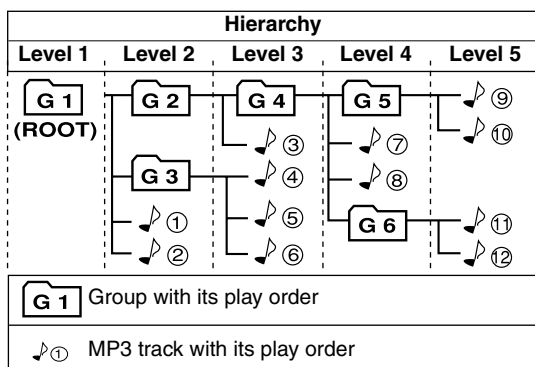

Using the disc player—Normal Play

To play a disc

1. Set a disc.

2. Press CD ►/II.

The first track of the disc starts playing.

For CDs:

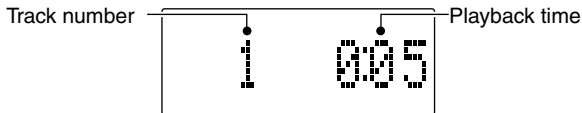

For MP3 discs:

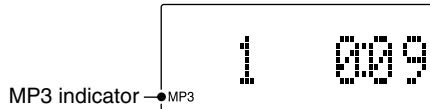

- When playing an MP3 disc, the file name (then ID3 Tag if any) is displayed at the beginning of each track.
- If no disc is inserted, “NO DISC” appears on the display and the system remains in stop mode.
- The system automatically stops when the last track of the disc has finished playing.

To stop playing the disc, press ■.

The following information for the disc is displayed.

For CDs:

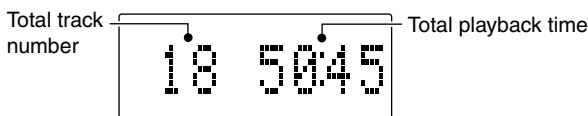

For MP3 discs:

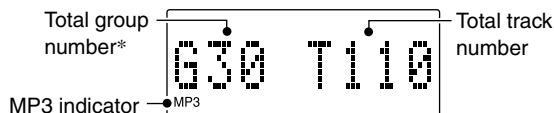

* If a disc includes more than 99 groups, “G –” will appear on the display.

To pause, press CD ►/II. The playback time flashes on the display.

To cancel pause, press the same button again. Playback continues from the point where it was paused.

Note: Do not turn the LOCK/RELEASE knob during playback.

Skip Play

Press ◀◀ or ▶▶ to select the track you want to play during playback.

- Press ▶▶ once to skip to the beginning of the next track.
- Press ◀◀ to skip to the beginning of the track being played. Press ◀◀ twice quickly to skip to the beginning of the previous track.

You can also select a track in stop mode with the same buttons.

For CD: Selected track and its playback time are shown on the display.

For MP3: Group and track numbers (then ID3 Tag if any) are shown on the display.

To start playback, press CD ►/II.

Search Play

Press and hold ◀◀ or ▶▶ to fast forward/reverse the disc during playback.

You can quickly find a particular passage in the track you are listening to. During search play, you can hear the sound of approx. one forth level.

To locate a track directly

Using the remote control only _____

Press the number buttons to directly play a track.

- To directly play track 5, press 5.
- To directly play track 15, press +10 then 5.
- To directly play track 20, press +10 once then press 10.

(Only for MP3 discs)

- To directly play track 109, press +100 once then press 9.
- To directly play track 125, press +100, +10, +10 then 5.

To select a group (for MP3 disc)

Using the remote control only _____

Press ^ GROUP UP or v GROUP DOWN to select the group you want to play during playing the MP3 disc.

- Press ^ GROUP UP to skip to the next group.
- Press v GROUP DOWN to skip to the previous group.

You can also select a group in stop mode with the same buttons.

To play the group after selection, press CD ►/II.

Programming the playing order of the tracks

Using the remote control only

- You can program up to 50 tracks in any desired order including the same tracks.
- You can only make a program when the system is stopped.
- While making a program, you cannot specify a group number to select a track.

1. Set a disc.

2. Press CD ►/II.

3. Press ■ to stop the disc.

4. Press PLAY MODE repeatedly to select "PROGRAM."

The system enters the programming mode and the PRGM indicator lights up.

5. Press the number buttons to select the track to program.

- For detailed operations, see "To locate a track directly" on page 11.

Example: For track 7, press 7.

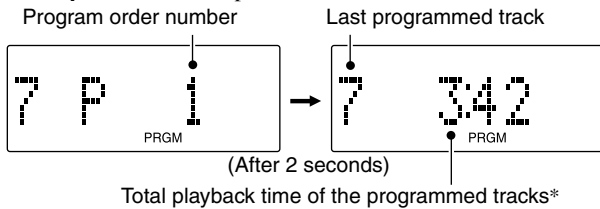

*Total playback time will not appear while making a program using an MP3 disc.

6. Repeat step 5. to select other tracks for the program.

- To cancel the last track programmed, press CANCEL once.

7. Press CD ►/II.

The system plays the tracks in the same order as you have programmed them.

- You can skip to a particular programmed track by pressing ◀◀ or ▶▶ during program play.

While stopped:

- **To confirm the programmed tracks**, press ◀◀ or ▶▶ repeatedly; the tracks making up the program will successively be displayed in the programmed order.
 - To add a track to the end of the program, simply press the number buttons.
- **To delete the tracks in the program**, press CANCEL repeatedly. Each time you press the button, the last track will be erased.
- **To delete the entire program**, press and hold CANCEL until "CLEAR!" appears on the display.
 - Turning off the power will clear the program.
- **To exit from program mode**, press PLAY MODE repeatedly until the PRGM indicator goes off. Each time you press the button, the play mode changes as follows:

Normal play → PROGRAM → RANDOM → (back to the beginning)

Note:

(For CDs) If the total playback time of the programmed tracks exceeds 99 minutes 59 seconds, "-- : --" will appear on the display.

Random play

The tracks will play in no special order when you use this mode.

Using the remote control only

1. Set a disc.

2. Press CD ►/II.

3. Press ■ to stop the disc.

4. Press PLAY MODE repeatedly to select "RANDOM."

The RANDOM indicator lights up on the display.

5. Press CD ►/II.

The tracks are played in random order once.

To skip a track during playback, press ▶▶ to skip to another track in the random sequence. The ◀◀ button works only to go back to the beginning of the current track.

While stopped:

- **To exit from random mode**, press PLAY MODE repeatedly until the RANDOM indicator goes off. Each time you press the button, the play mode changes as follows:

Normal play → PROGRAM → RANDOM → (back to the beginning)

Repeating tracks

You can repeat the tracks or individual track as many times as you like.

Using the remote control only

Press REPEAT.

Each time you press the button, repeat indicator changes as follows:

For CDs:

- ◀ → ALL → ◀ → canceled → (back to the beginning)
- ◀ ALL: Repeats all the tracks on the disc.
- ◀ : Repeats the current track.

For MP3 discs:

- ◀ → ALL → ◀ → GROUP → ◀ → canceled → (back to the beginning)
- ◀ ALL: Repeats all the tracks on the disc.
- ◀ GROUP: In normal play mode, repeats all the tracks in a group. In program and random play modes, group repeat cannot be selected.
- ◀ : Repeats the current track.

- Repeat mode (except "◀ GROUP") remains in effect even when you change the play mode.

To exit from repeat mode, press REPEAT repeatedly until the repeat indicator on the display goes off.

Listening to the iPod

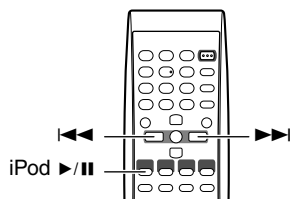

You can operate an iPod through the system.

- Before connecting your iPod to the system, check its type and software version (see page 4).
- Remember you cannot send any data to your iPod from the system.
- You can also operate the iPod directly even while it is connected to the system. For details of the operation, refer to the instructions of your iPod.

CAUTIONS:

- The iPod battery is charged while the system is turned on. See the iPod instruction manual about charging times.
- Sound distortion may occur when playing back audio sources with high recording levels. Adjusting the iPod's equalizer to "Flat" is recommended. For information on operating the iPod, see the iPod instruction manual.
- JVC is not responsible for any loss of or damage to iPod that might result from the use of this product.
- When you connect your iPod to the cable, make sure it connects all the way in.
- Do not carry the system with iPod connected. You might drop it down or it might cause damages to the connector part.
- Do not touch or hit the iPod terminal pins or the connector pins directly. It might cause damages to the connector part.
- Remove the iPod from the cable when you do not use.

Playing the iPod

To play the iPod

1. Set the volume level to minimum.

2. Press iPod ►/||.

The iPod is turned on and starts playing.

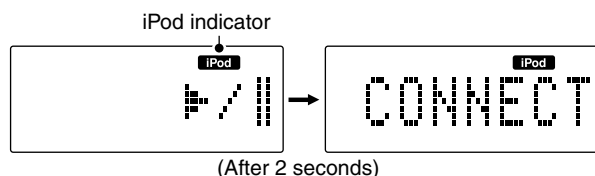

3. Adjust the volume to the desired listening level.

To pause, press iPod ►/||.

To cancel pause, press the same button again. Playback continues from the point where it was paused.

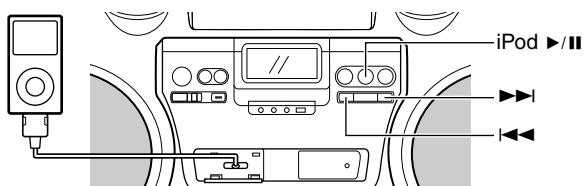

Skip Play

Press ◀◀ or ▶▶ to select the track you want to play during playback.

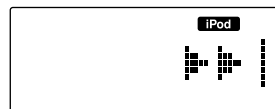

- Press ▶▶ once to skip to the beginning of the next track.
- Press ◀◀ to skip to the beginning of the track being played. Press ◀◀ twice quickly to skip to the beginning of the previous track.

You can also select a track with the same buttons while the iPod is paused.

To start playback, press iPod ►/||.

Search Play

Press and hold ◀◀ or ▶▶ to fast forward/reverse the track during playback.



You can quickly find a particular passage in the track you are listening to. During search play, you can hear the sound of approx. one forth level.

NOTE:

When iPod is selected as the source...

- "CONNECT" appears on the display with the iPod connected.
- "NO CONNECT" scrolls on the display without the iPod connected.

Turning off the iPod

Press and hold iPod ►/|| for about 2 seconds.

- Turning off the system* or changing iPod to another source also turns off the iPod.

*Turning off the system may not turn off the iPod depending on the current source.

About the battery charge of the iPod

- When the system is operated on the AC power:
The iPod battery is always charged except while FM/AM is selected as the source.
- When the system is operated on the batteries or the car battery (DC12V):
The iPod battery is charged only while the system is turned on without FM/AM selected as the source.
 - The iPod battery will not be charged while "DC OFF" is flashing on the display (see page 6).

Listening to auxiliary equipment

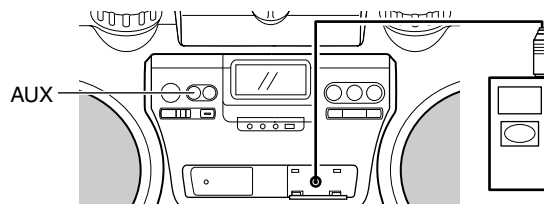
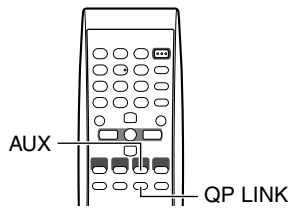

You can listen to auxiliary equipment.

First make sure that the auxiliary equipment is properly connected to the system. (See pages 5 and 6.)

Note: For operation of the auxiliary equipment, refer to its instructions.

Listening to auxiliary equipment

1. Set the volume level to minimum.

2. Press AUX.

“AUX” appears on the display.

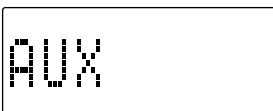

- To listen to the auxiliary equipment, start playing the auxiliary equipment.

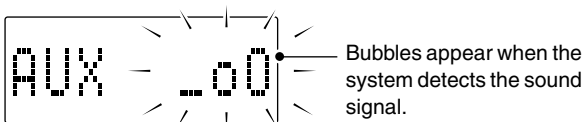

3. Adjust the volume to the desired listening level.

4. Apply sound effects, if you wish.

- Adjust the super woofer volume to reinforce the bass sound.

Switching to AUX automatically—QP Link

Quick Portable Link (QP Link) automatically switches the source to AUX as the auxiliary equipment connected to the AUX jack starts playback.

Using the remote control only

To activate QP Link

Press QP LINK repeatedly to show “QPL ON” on the display.

- The QP LINK indicator appears on the display in the following cases to inform you that QP Link is ready to work:
- When an auxiliary equipment is connected to the AUX jack.
 - When AUX is selected as the source.

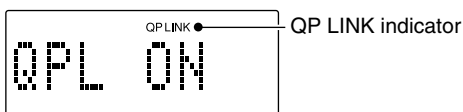

To cancel, press QP LINK repeatedly to show “QPL OFF” on the display.

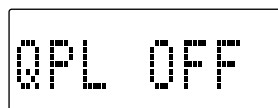

■ How does QP Link work?

While QP Link is activated, starting playback performs the following:

- While listening to another source, Changes the source to AUX.
- When the power is supplied through the AC outlet and the system is turned off, Turns on the system and selects AUX as the source.

NOTES:

- When the sound signal from the auxiliary equipment is too weak, QP Link may not function correctly. In this case, turn up the volume of the auxiliary equipment so that the system can detect the sound signal properly.
- If you change the source from AUX with QP Link turned on, QP Link will be deactivated temporarily. In this case, the following reactivate QP Link:
 - When the auxiliary equipment is unplugged from the AUX jack, then plugged in again.
 - When the sound signal from AUX jack stops or becomes very weak for about 30 seconds.
- If the system is turned off while QP Link is working, QP Link will be deactivated temporarily. In this case, QP Link is reactivated when the sound signal from AUX jack stops or becomes very weak for about 30 seconds after the system is turned off.
- While QP Link is activated, QP Link may start working when you just connect the auxiliary equipment to the AUX jack or unplug it. This is not a malfunction.

Changing the AUX jack sensitivity

You can change the AUX jack sensitivity when QP Link mistakenly works with detecting non-playback signals from the auxiliary equipment, such as its switching noise.

Using the remote control only

Press and hold QP LINK.

Each time you press and hold QP LINK, the sensitivity level changes between QPL LV1 and QPL LV2.

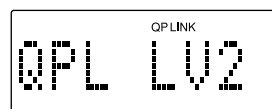

QPL LV1: Normally select this (initial setting).

QPL LV2: Select this when QP Link works mistakenly.

Using the microphone/guitar

Microphone/guitar mixing

Using a microphone or a guitar (not supplied), you can mix its sound with a source sound.

1. Make sure the MIC/GUITAR LEVEL control on the rear of the system is properly set.

- When using a microphone, make sure the knob is pressed in (■).
- When using a guitar, make sure the knob is released (□).

2. Set the MIC/GUITAR LEVEL control to MIN by turning it fully counterclockwise.

3. Connect a microphone or a guitar into the MIC/GUITAR INPUT jack on the rear of the system.

4. Start a source: disc, tuner, iPod, or auxiliary equipment.

5. Adjust the VOLUME +/- control and the MIC/GUITAR LEVEL control, as you play the microphone or the guitar.

CAUTION:

DO NOT connect a bass guitar to the MIC/GUITAR INPUT jack, as it may damage the system.

Using the timer

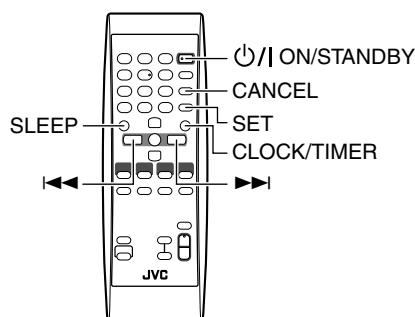

The timers let you control the listening functions automatically.

Setting the clock

When the power is first supplied, the CLOCK indicator and “0:00” flash on the display. Set the clock.

Note:

The clock must be correctly set for the timers to work.

Using the remote control only

1. Press ON/STANDBY.

2. Press CLOCK/TIMER repeatedly until the CLOCK indicator lights up.

The hour digit flashes on the display.

3. Press >>> or <<< to select the hour.

- When you press and hold the button, the hour digit changes continuously.

4. Press SET to set the hour.

The minutes digits start flashing on the display.

5. Press >>> or <<< to select the minute.

- When you press and hold the button, the minute digit changes continuously.
- If you want to change the hour setting, press CANCEL.

6. Press SET to finish setting the clock.

CAUTION:

If memory backup batteries are exhausted or not installed, and the AC power cord is plugged in again after being disconnected, or power is restored after a power failure, the CLOCK indicator will flash on the display. Set the current time (clock) again.

Setting the sleep timer

Use the sleep timer to turn the system off after a certain number of minutes when it is playing. By setting the sleep timer, you can fall asleep to the music and know that your system will turn off by itself rather than playing all night.

- You can set the sleep timer only when the system is turned on.

Using the remote control only

1. Press SLEEP.

The SLEEP indicator lights up on the display.



2. Set the length of time you want the source to play before shutting off.

Each time you press the button, it changes the number of minutes shown on the display in this sequence:

10 → 20 → 30 → 60 → 90 → 120 → OFF → (back to the beginning)

After setting the number of minutes for the sleep timer, the indication will stop flashing and go off.

The system is now set to turn off after the number of minutes you set.

To confirm the sleep time:

When SLEEP is pressed, the remaining sleep time is displayed. Wait until the display returns to the original display.

To cancel the sleep timer:

Press SLEEP repeatedly to select "OFF." Turning off the system also cancels the sleep timer.

Setting the daily timer

Once the timer has been set, it will be activated at the same time everyday until the timer is turned off.

- While the timer is being set, the timer indicator (⏻) lights up.
- After the timer has been set, the timer indicator (⏻) also lights up if the power is supplied through the AC outlet.
- While the timer is working, the timer indicator (⏻) flashes.

Using the remote control only

1. Press ⏻/I ON/STANDBY.

2. Press CLOCK/TIMER.

"TIMERON?" appears.

- Press SET to activate the timer setting you have made before.
- Press CANCEL to cancel the timer.
- Go to the next step to set the timer first time (or reset the timer).

3. Press CLOCK/TIMER again, so that the timer indicator (⏻) and ON indicator light up.

The hour digit of the current ON time flashes on the display.

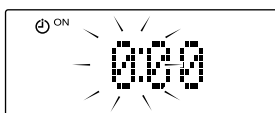

4. Set the on-time you want the system to turn on.

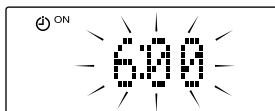

- (1) Press ►► or ◀◀ to select the hour, then press SET.
- (2) Press ►► or ◀◀ to select the minute, then press SET.
The OFF indicator lights up.
 - Press and hold the button to change the time rapidly.
 - If you want to change the time setting, press CANCEL.

5. Set the OFF time (example: 8:30).

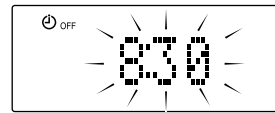

- (1) Press ►► or ◀◀ to select the hour, then press SET.
- (2) Press ►► or ◀◀ to select the minute, then press SET.
 - Press and hold the button to change the time rapidly.
 - If you want to change the time setting, press CANCEL.

6. Press ►► or ◀◀ to select the music source you want to listen to, then press SET.

Each time you press the button, the display changes as shown below:

TUNER → CD → iPod → (back to the beginning)

7. Press ►► or ◀◀ to select the volume level, then press SET.

--: The current volume level will be used.

0 to 50: When the timer is turned on, the volume will be automatically set to the selected level.



- The current timer setting appears for confirmation.

8. Before turning off the system, prepare the music source selected in step 6.

TUNER: Tune in to the desired frequency (FM/AM).

CD: Set a disc.

iPod: Connect an iPod to the iPod jack.

9. Press ⏻/I ON/STANDBY to turn off the system.

- When the timer turns on, the volume level gradually increases from 0 (zero) to the preset level in step 7.

However, if the volume has been set to "--", the volume level will be set to the last level directly.

To cancel the operation, press CLOCK/TIMER until the display returns to the original one.

To cancel the timer, press CLOCK/TIMER once, then press CANCEL. ("TIMEROFF" appears, only when power is on.)

To reactivate (or confirm) the canceled timer, press CLOCK/TIMER once, then press SET. (The current timer setting appears for confirmation.)

Notes:

- The timer cannot be set if on-time and off-time are the same.
- The timer does not work if the system is not in the standby mode (the system needs to be in standby mode at least one minute before the on-time).

CAUTION:

If memory backup batteries are exhausted or not installed, and the AC power cord is disconnected or there is a power failure, time settings will be erased from memory. If this happens, set the current time (clock) and perform the timer setting again.

Care and maintenance

Handle your discs carefully, and they will last a long time.

Compact discs



- This system can play back the following discs:
 - Audio CD
 - Finalized CD-R/CD-RW recorded in audio CD format or MP3 format

However, continued use of irregular shape discs (heart-shape, octagonal, etc.) can damage the system.

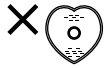

- Remove the disc from its case by holding it at the edges while pressing the case's center hole lightly.

- Do not touch the shiny surface of the disc, or bend the disc.

- Put the disc back in its case after use to prevent warping.

- Be careful not to scratch the surface of the disc when placing it back in the case.

- Avoid exposure to direct sunlight, temperature extremes, and moisture.

- A dirty disc may not play correctly. If a disc does become dirty, wipe it with a soft cloth in a straight line from center to edge.



CAUTION:

Do not use any solvent (for example, conventional record cleaner, spray thinner, benzene, etc.) to clean a disc.

General notes

In general, you will have the best performance by keeping your discs and the mechanism clean.

- Store discs in their cases, and keep them in cabinets or on shelves.
- Keep the disc compartment door closed when not in use.

Cleaning the lens

If the lens in the pickup is dirty, dropout, etc., could degrade sound. Open the disc compartment door and clean the lens as shown.

- Use a blower (available at camera stores) to blow dust off the lens.

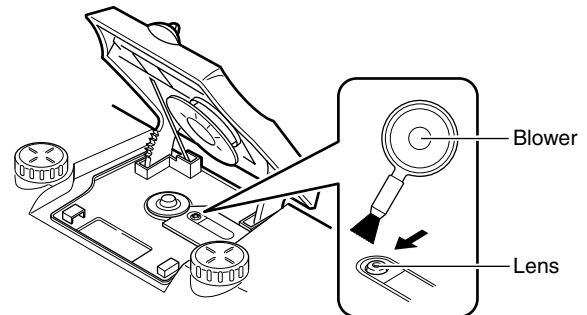

- If there are fingerprints, etc. on the lens, gently wipe clean with a cotton swab.

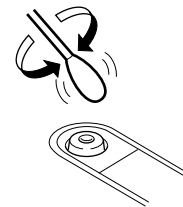

Moisture condensation



Moisture may condense on the lens inside the system in the following cases:

- After turning on heating in the room.
- In a damp room.
- If the system is brought directly from a cold to a warm place.

Should this occur, the system may malfunction. In this case, leave the system turned on for a few hours until the moisture evaporates, unplug the AC power cord, and then plug it in again.

Troubleshooting

- If you are having a problem with your system, check this list for a possible solution before calling for service.
- If you cannot solve the problem from the hints given here, or the system has been physically damaged, call a qualified person, such as your dealer, for service.

Symptom	Possible cause	Action
• Power does not come on.	• The power cord is not connected to an AC outlet.	• Insert the plug into the socket.
• No sound is heard.	• Connections are incorrect, or loose. • Headphones are connected. • MP3 disc is recorded with "packet writing."	• Check all connections and make corrections. (See pages 5 and 6.) • Disconnect the headphones. • It cannot be played. Replace the disc.
• Poor FM reception.	• The FM telescopic antenna is not properly extended and positioned.	• Fully extend the FM telescopic antenna and turn it for the best reception.

Symptom	Possible cause	Action
<ul style="list-style-type: none"> The track skips. 	<ul style="list-style-type: none"> The disc is dirty or scratched. 	<ul style="list-style-type: none"> Clean or replace the disc.
<ul style="list-style-type: none"> The disc does not play (“NO PLAY” or “NO DISC” appears). 	<ul style="list-style-type: none"> The disc is upside down. The disc is dirty or scratched. 	<ul style="list-style-type: none"> Put the disc in with the label side up. Change the disc.
<ul style="list-style-type: none"> Specific files (tracks) on an MP3 disc are not played. 	<ul style="list-style-type: none"> Files other than MP3 are included in the disc. 	<ul style="list-style-type: none"> They cannot be played.
<ul style="list-style-type: none"> iPod is not turned on. 	<ul style="list-style-type: none"> Connection is not firmly made. 	<ul style="list-style-type: none"> Check the connection. (See page 6.)
<ul style="list-style-type: none"> iPod does not play though “CONNECT” appears on the display. 	<ul style="list-style-type: none"> The battery of the iPod is empty. 	<ul style="list-style-type: none"> Leave the iPod connected for more than approximately ten minutes.
<ul style="list-style-type: none"> iPod is not charged. 	<ul style="list-style-type: none"> FM/AM is selected as the source. The system is in a standby mode when the system is operated on the batteries or the car battery (DC12V). 	<ul style="list-style-type: none"> Select any source other than FM/AM. Turn on the system.
<ul style="list-style-type: none"> Unable to operate the remote control. 	<ul style="list-style-type: none"> The path between the remote control and the sensor on the system is blocked. The batteries have lost their charge. 	<ul style="list-style-type: none"> Remove the obstruction.
<ul style="list-style-type: none"> Operations are disabled. 	<ul style="list-style-type: none"> The built-in microprocessor has malfunctioned due to external electrical interference. 	<ul style="list-style-type: none"> Replace the batteries.
<ul style="list-style-type: none"> Indicators and the display do not light up while in standby mode. 	<ul style="list-style-type: none"> Batteries or DC power is used to supply the power. 	<ul style="list-style-type: none"> Unplug the system then plug it back in after a few minutes.

Specifications

Amplifier

Output Power (Max.)	20 W (10W + 10W) at 4 Ω (full range), 40 W (20W + 20W) at 4 Ω, 60 Hz (woofer)
(10% THD)	10 W (5W + 5W) at 4 Ω (full range), 30 W (15W + 15W) at 4 Ω, 60 Hz (woofer)
Input Sensitivity/Impedance (1 kHz)	
AUX	300 mV/47 kΩ
MIC/GUITAR INPUT:	Switchable
MIC	200 Ω – 2 kΩ (6.3 mm dia. plug)
GUITAR	100 kΩ – 1 MΩ (6.3 mm dia. plug)
Output Sensitivity/Impedance (1 kHz)	
PHONES	16 Ω – 1 kΩ 0 – 12 mW/ch output into 32 Ω

Disc Player

Dynamic range	90 dB
Signal-to-noise ratio	95 dB
Wow and Flutter	Unmeasurable

Tuner

FM Tuner	
Tuning Range	87.50 MHz – 108.00 MHz
AM Tuner	
Tuning Range	522 – 1 629 kHz
Antenna	FM telescopic antenna Ferrite core antenna for AM

Speakers

Full range	8 cm × 2, 4 Ω
Super woofer	16 cm × 2, 4 Ω

General

Dimensions	690 mm × 239 mm × 293 mm (W/H/D)
Mass	9.2 kg (without batteries) 10.3 kg (with batteries)

Power Specifications

Power Requirements	AC 230 V ~ , 50 Hz DC 15 V (“R20/D(13F)” batteries [10]) External DC 12 V (car battery via optional car adapter)
Power Supply to iPod	5 V/500 mA
Power Consumption	
AC 230 V ~ , 50 Hz	43 W (power on mode) 1.2 W (in standby mode)
External DC 12 V	2 A (power on mode)

Design and specifications are subject to change without notice.

RV-NB20B/RV-NB20W

POWERED WOOFER CD SYSTEM

JVC