



ENGLISH

DEUTSCH

FRANÇAIS

ITALIANO

ESPAÑOL

РУССКИЙ

中文

VIDEO INPUT CARD

BEDIENUNGSANLEITUNG: VIDEO-EINGANGSKARTE
MANUEL D'INSTRUCTIONS: CARTE D'ENTRÉE VIDÉO
ISTRUZIONI: SCHEDA DI INGRESSO VIDEO
MANUAL DE INSTRUCCIONES: TARJETA DE ENTRADA VIDEO COMPUESTO
ИНСТРУКЦИЯ ПО ЭКСПЛУАТАЦИИ:

МОДУЛЬ VIDEO ВХОДОВ

使用说明书:

视频输入卡

IF-CF01PNG

INSTRUCTIONS

JVC

ENGLISH

VIDEO INPUT CARD

IF-CF01PNG

INSTRUCTIONS

Thank you for purchasing this JVC Input Card. In order to take full advantage of the card's capabilities, please read and follow all instructions carefully before installing and using the card. Retain this booklet for future reference.

Precautions



Before installing this Input Card in your monitor, please read the Safety Precautions included in your monitor's user manual.

FCC NOTICE (U.S.A. only)

CAUTION: Changes or modifications not approved by JVC could void the user's authority to operate the equipment.

NOTE: This equipment has been tested and found to comply with the limits for a Class A digital device, pursuant to Part 15 of the FCC Rules. These limits are designed to provide reasonable protection against harmful interference when the equipment is operated in a commercial environment. This equipment generates, uses, and can radiate radio frequency energy and, if not installed and used in accordance with the instruction manual, may cause harmful interference to radio communications. Operation of this equipment in a residential area is likely to cause harmful interference in which case the user will be required to correct the interference at his own expense.

EUROPE EMC STANDARD NOTICE (Europe only)

Warning: This is a class A product. In a domestic environment this product may cause radio interference in which case the user may be required to take adequate measure.

EMC Supplement (Europe only)

This equipment is in conformity with the provisions and protection requirements of the corresponding European Directives. This equipment is designed for professional video appliances and can be used in the following environments:

- Controlled EMC environment (for example purpose built broadcasting or recording studio), and the rural outdoors environment (far away from railways, transmitters, overhead power lines, etc.)

These input cards are only for use with specific monitors.

Consult your dealer for the compatible monitors.

Information for Users on Disposal of Old Equipment



[European Union]

This symbol indicates that the electrical and electronic equipment should not be disposed as general household waste at its end-of-life. Instead, the product should be handed over to the applicable collection point for the recycling of electrical and electronic equipment for proper treatment, recovery and recycling in accordance with your national legislation.

Attention:

This symbol is only valid in the European Union.

By disposing of this product correctly, you will help to conserve natural resources and will help prevent potential negative effects on the environment and human health which could otherwise be caused by inappropriate waste handling of this product. For more information about collection point and recycling of this product, please contact your local municipal office, your household waste disposal service or the shop where you purchased the product.

Penalties may be applicable for incorrect disposal of this waste, in accordance with national legislation.

(Business users)

If you wish to dispose of this product, please visit our web page www.jvc-europe.com to obtain information about the take-back of the product.

[Other Countries outside the European Union]

If you wish to dispose of this product, please do so in accordance with applicable national legislation or other rules in your country for the treatment of old electrical and electronic equipment.

Before Installation

■ Accessories

- Label (x 1): For placing to the rear panel and the remote control of the monitor after installing the Input Card.
- Slot cover (x 1): For covering the blank slot.

■ Preparation

- Wear gloves to protect your hands from metal parts on the Input Card's board.
- You will need a 6 mm Phillips screwdriver.
- Turn off the monitor's main power and unplug the power cable from the AC outlet.
- Place the monitor with its LCD panel side down on a soft cloth so as not to damage the LCD panel.

■ Cautions

- Do not touch the terminals or board pattern of the Input Card to keep it from being damaged by static electricity.
- Do not damage the Input Card's connection terminal.
- Do not put anything into the Input Card's holes or intakes.
- Do not force the Input Card into the monitor's slot.
- Attach the slot cover on the monitor's slot in which no Input Card is installed.
- Attach the Input Card before mounting the monitor on the stand or wall mounting unit.

Installation

■ Installation procedure

- 1. Remove the slot cover from the slot on the bottom side of the monitor.**

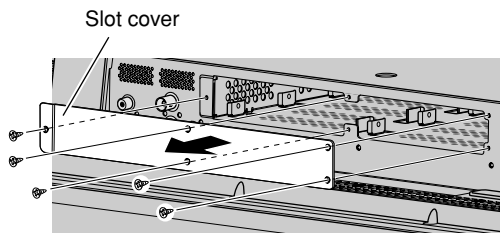

The monitor in the illustration is GM-H40L2.

Installation (continued)

2. Insert the Input Card into the slot, fitting into the guides inside the slot, so that its panel touches the bottom of the monitor.

You can install the Input Card(s) into either left or right slot. When installing, follow the procedure below.

• When installing two Input Cards:

Install either of Input Cards into the left slot first.

• When installing only one Input Card:

You need to attach the supplied slot cover to the blank slot.

Install either Input Card or the supplied slot cover into the left slot first as illustrated on the right.

Ex.: When installing only one Input Card
Insert ①, then ②.

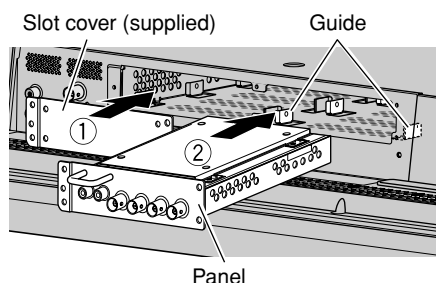
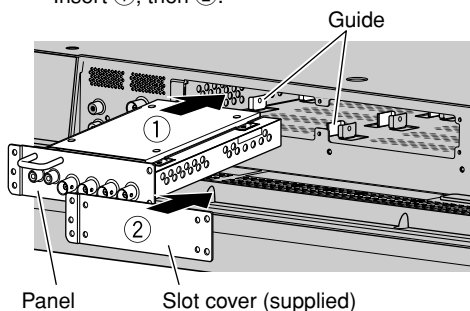

3. Secure the Input Card by using the screws removed in Step 1 on the previous page.

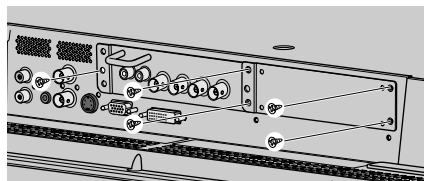

After installation

- Place the supplied labels on the rear panel and the remote control of the monitor as illustrated on the right.
 - **On the rear panel:** Place the label on the name of the slot into which you have installed the Input Card.
 - **On the remote control:** Place the label on the printing of the corresponding input select buttons.
- Make sure the Input Card is correctly recognized by “INPUT CONFIGURATION” (“INPUT C” – “INPUT F”) on the main menu of the monitor.

On the rear panel

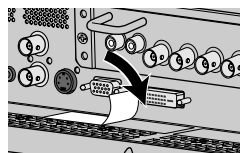

On the remote control



Controls and Features

Front view

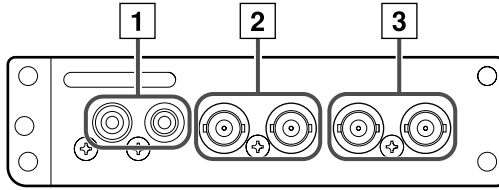

Label

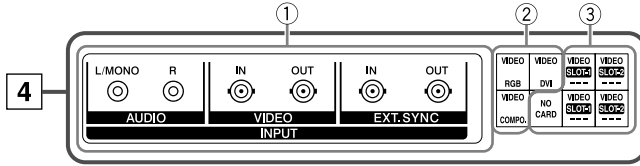

Rear view

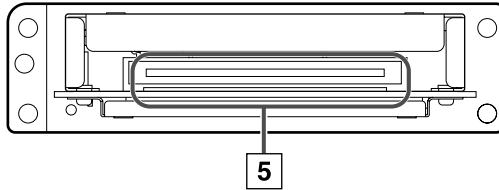

1 Audio signal input terminals

Accepts analog audio signals.

Connect only the L/MONO terminal for monaural sound.

2 Composite signal input/output terminals

Accepts composite signals.

See page 8 for the signal formats compatible with this input card.

Select input by using the button on the monitor.

Input select: INPUT C (SLOT-1)/E (SLOT-2)

➔ NTSC and PAL are switched by setting “COLOR SYSTEM” on the monitor. Refer to your monitor instruction manual for more information.

NOTE:

- The IN and OUT terminals are bridge-connected (auto termination).

3 Synchronized signal input/output terminals

Accepts the synchronized signals (Black burst signals).

➔ When using these terminals, set “SYNC SELECT” to “EXT.” on the monitor. Refer to your monitor instruction manual for more information.

NOTE:

- The IN and OUT terminals are bridge-connected (auto termination).

4 Label (see page 5)

- ① **On the rear panel:** Place the label on the name of the slot into which you have installed the Input Card.
- ② **On the remote control:** When the input signal type for input B is fixed (RGB, COMPO., or DVI), place the corresponding label on the printing of the input select buttons A and B.
- ③ **On the remote control:** Place the label on the printing of the input select buttons (C/D or E/F) for the slot into which you have installed the Input Card. (“NO CARD” is for a blank slot.)

5 Connection terminal (on the rear side)

Attach to the connection terminal in the slot of your monitor.

Specifications

Model name:	IF-CF01PNG
Type:	Video Input Card
Target monitors:	Consult your dealer.
Inputs/Outputs:	Composite signal input/output: VIDEO: 1 line, BNC x 2, 1.0 V(p-p), 75 Ω <ul style="list-style-type: none">• The IN and OUT terminals are bridge-connected (auto termination). Synchronized signal (Black burst signal) input/output: EXT. SYNC: 1 line, BNC x 2, 0.3 V(p-p), 75 Ω <ul style="list-style-type: none">• The IN and OUT terminals are bridge-connected (auto termination). Audio signal input: AUDIO (L/MONO, R): 1 line, RCA x 2, 0.5 V(rms)
Compliant signal format:	NTSC, PAL, SECAM, PAL60, NTSC4.43, PAL M, PAL N, BW (50 Hz/60 Hz)
Required slots:	1
Weight:	0.4 kg (0.9 lbs)
Dimensions (W x H x D):	133 mm x 34.5 mm x 185 mm (5 1/4 inch x 1 3/8 inch x 7 3/8 inch)

■ Dimensions

Unit: mm (inch)

Front View (Terminal Side)

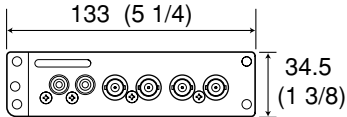

Top View

