

JVC



DVD PLAYER

XV-M555BK

| | |
|------------------------|----|
| Introduction | 1 |
| Preliminary knowledge | 4 |
| Getting started | 12 |
| Basic operations | 17 |
| Advanced operations | 20 |
| Initial settings | 35 |
| Additional information | 41 |

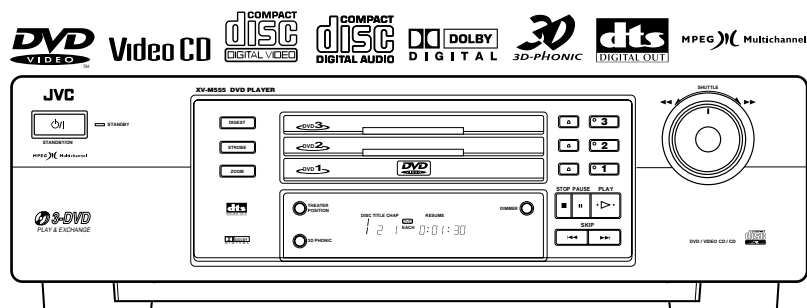
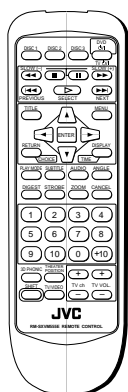

INSTRUCTIONS

For Customer Use:

Enter below the Model No. and Serial No. which are located on the rear, bottom or side of the cabinet. Retain this information for future reference.

Model No. _____

Serial No. _____

LVT0391-003A
[B, E, EV]

Warnings, Cautions and Others

IMPORTANT for the U.K.

DO NOT cut off the mains plug from this equipment. If the plug fitted is not suitable for the power points in your home or the cable is too short to reach a power point, then obtain an appropriate safety approved extension lead or consult your dealer.

BE SURE to replace the fuse only with an identical approved type, as originally fitted.

If nonetheless the mains plug is cut off ensure to remove the fuse and dispose of the plug immediately, to avoid a possible shock hazard by inadvertent connection to the mains supply.

If this product is not supplied fitted with a mains plug then follow the instructions given below:

IMPORTANT.

DO NOT make any connection to the terminal which is marked with the letter E or by the safety earth symbol or coloured green or green-and-yellow.

The wires in the mains lead on this product are coloured in accordance with the following code:

Blue : Neutral
Brown : Live

As these colours may not correspond with the coloured markings identifying the terminals in your plug proceed as follows:

The wire which is coloured blue must be connected to the terminal which is marked with the letter N or coloured black.

The wire which is coloured brown must be connected to the terminal which is marked with the letter L or coloured red.

IF IN DOUBT - CONSULT A COMPETENT ELECTRICIAN.

Caution —  button!

Disconnect the mains plug to shut the power off completely. The  button in any position do not disconnect the mains line. The power can be remote controlled.

CAUTION

To reduce the risk of electrical shocks, fire, etc.:

1. Do not remove screws, covers or cabinet.
2. Do not expose this appliance to rain or moisture.

Caution: Proper Ventilation

To avoid risk of electric shock and fire and to protect from damage.

Locate the apparatus as follows:

- Front: No obstructions open spacing.
Sides: No obstructions in 3 cm from the sides.
Top: No obstructions in 5 cm from the top.
Back: No obstructions in 15 cm from the back
Bottom: No obstructions, place on the level surface.

IMPORTANT FOR LASER PRODUCTS

REPRODUCTION OF LABELS

① CLASSIFICATION LABEL, PLACED ON REAR ENCLOSURE

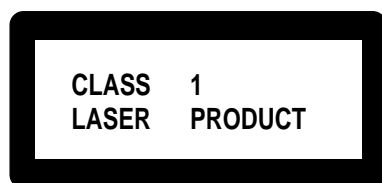

1. CLASS 1 LASER PRODUCT
2. **DANGER:** Visible laser radiation when open and interlock failed or defeated. Avoid direct exposure to beam.
3. **CAUTION:** Do not open the top cover. There are no user serviceable parts inside the Unit; leave all servicing to qualified service personnel.

② WARNING LABEL, PLACED INSIDE THE UNIT

| | |
|-----------|--|
| CAUTION | - LASER RADIATION WHEN OPEN. DO NOT STARE INTO BEAM. |
| ATTENTION | - RAYONNEMENT LASER EN CAS D'OUVERTURE. NE PAS REGARDER DANS LE FAISCEAU. |
| VORSICHT | - LASERSTRAHLUNG, WENN ABDECKUNG GEÖFFNET. NICHT IN DEN STRAHL BLICKEN. |
| ADVARSEL | - LASERSTRÅLING VED ÅBNING. SE IKKE IND I STRÅLEN. |
| ADVARSEL | - LASERSTRÅLING NÅR DEKSEL ÅPNES. STIRR IKKE INN I STRÅLEN. |
| VARNING | - LASERSTRÅLING NÅR DENNA DEL ÄR ÖPPNAD. STRÅR EJ IN I STRÅLEN. |
| VARO! | - AVATTAESSA OLET ALLTIINA LASERSÄTELYLLE. ÄLÄ TUJUJOTA SÄTEESEEN. |
| 注意 | - 当打开这里会出现激光, 请不要直视激光。 |
| 注意 | - ここを開くとレーザー光が出ます。 レーザー光をのぞき込まないでください。 |

Features

Picture functions

- **Strobe function**
The unit can display nine continuous still pictures on the TV screen.
- **Digest function**
You can select the desired title from the opening scenes displayed on the TV screen.
- **Angle function***
You can select a desired angle from multiple camera angles recorded on the DVD disc.
- **Zoom function**
You can view scenes close-up.
- **Parental lock***
You can restrict the playback of DVD discs with scenes which you do not want children to see, such as adult or violent films.
- **Theater position**
You can select the picture character according to the lighting of your room.

Audio functions

- **High quality digital sound**
You can enjoy high quality sound with Dolby Digital, MPEG Audio or Linear-PCM.
- **Surround function***
The unit is compatible with Dolby Digital surround, DTS surround and MPEG multichannel. (DTS surround and MPEG multichannel are available for digital output only.)
- **3D Phonic function**
You can enjoy surround sound with your 2-channel system.

Other functions

- **Triple disc trays**
You can insert up to three discs in the unit and can playback them continuously.
- **Multi-language subtitles and sound***
You can select a subtitle or sound language from those recorded on the DVD disc.
- **Multi-disc playback**
You can enjoy Audio CD discs and Video CD discs, as well as DVD discs.
- **Operation from the on-screen display**
User-friendly on-screen displays allow you to operate the unit easily.

Functions with (*) mark only work on a DVD disc that is compatible with each function.

Supplied accessories

- Audio/video cable (x 1)



- S-video cable (x 1)



- Remote Control Unit (x 1)

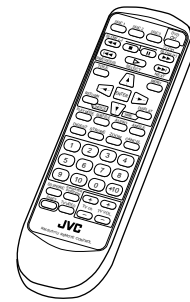

- R6P(SUM-3)/AA(15F) batteries (x 2)

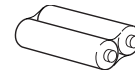

- Instruction manual(s)
(You may have more than one manual with different languages.)

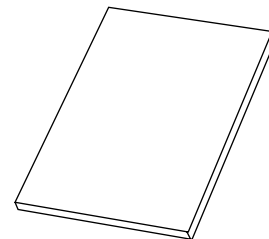

- AC power cord (x 1)

About this instruction manual

This instruction manual basically explains operations as follows:

Advanced operations

To playback titles or tracks in random order [RANDOM]



You can play titles or tracks on the discs inserted in random order by using the Random function.

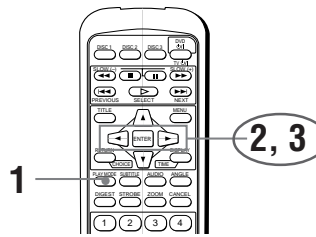

■ While stopped

1 Press PLAY MODE.
The play mode menu appears on the TV screen.

2 Use CURSOR ◀▶ to move  to [RANDOM].

REPEAT PROGRAM **RANDOM**

3 Press **ENTER**.

The unit starts random playback of the selected disc.
When all titles/tracks of the disc have been played once, the unit starts random playback of the next disc (if inserted). After playing all titles/tracks of the second disc, the unit starts random playback of the third disc (if inserted). After playing all titles/tracks of all the discs, random playback ends.

 **Hints**

The same title or track will not be played back more than once during random play.

- **To stop/quit random playback in the middle**
Press ■ to stop playback. The unit is still in random playback mode, so pressing ▷ starts random playback again.
To quit random playback, press ■ again while stopped.

NOTE

Some DVD discs may not be played back correctly in random mode.

These symbols indicate the types of discs which the operation can be used for.

The number indicates the following procedural step(s) in which the button(s) is(are) used.
You may also use the corresponding buttons on the front panel of the unit if available.

The names of buttons on the remote control unit (or on the front panel of the unit) are all given in uppercase letters.

The number indicates the procedural step.

Other convenient procedures, etc.

Additional supplemental remarks

Notes on handling

Important cautions

Installation of the unit

- Select a place which is level, dry and neither too hot nor too cold (between 5°C and 35°C, 41°F and 95°F).
- Leave sufficient distance between the unit and the TV.
- Do not use the player in a place subject to vibrations.

Power cord

- Do not handle the power cord with wet hands!
- A small amount of power (3.8 watts) is always consumed while the power cord is connected to the wall outlet.
- When unplugging the player from the wall outlet, always pull the plug, not the power cord.

To prevent malfunction of the unit

- There are no user-serviceable parts inside. If anything goes wrong, unplug the power cord and consult your dealer.
- Do not insert any metallic object into the unit.
- Do not use any non-standard shape disc available on the market, because it may damage the unit.
- Do not use a disc with tape, seals, or paste on it, because damage to the unit may result.

Note about copyright laws

- Please check the copyright laws in your country before recording from DVD VIDEO, Audio CD, and Video CD discs. Recording of copyrighted material may infringe copyright laws.

Note about the copyguard system

- The DVD VIDEO disc is protected by the copyguard system. When you connect the unit to your VCR directly, the copyguard system activates and the picture may not be played back correctly.

Safety precautions

Avoid moisture, water and dust

Do not place your player in moist or dusty places.

Avoid high temperatures

Do not expose the unit to direct sunlight or place it near a heating device.

When you're away

When away on travel or otherwise for an extended period of time, remove the plug from the wall outlet.

Do not insert foreign objects into the unit

Do not insert wires, hairpins, coins, etc. into the unit.

Do not block the vents

Blocking the vents may damage the unit.

Care of the cabinet

When cleaning the unit, use a soft cloth and follow the relevant instructions on the use of chemically-coated cloths. Do not use benzene, thinner or other organic solvents and disinfectants. These may cause deformation or discoloring.

If water gets inside the unit

Turn off the power switch and remove the plug from the wall outlet, then call the store where you made your purchase. Using the unit in this state may cause a fire or electrical shock.

This product incorporates copyright protection technology that is protected by method claims of certain U.S. patents and other intellectual property rights owned by Macrovision Corporation and other rights owners. Use of this copyright protection technology must be authorized by Macrovision Corporation, and is intended for home and other limited viewing uses only unless otherwise authorized by Macrovision Corporation. Reverse engineering or disassembly is prohibited.

Manufactured under license from Dolby Laboratories. "Dolby" and double-D symbol are trademarks of Dolby Laboratories.

Confidential Unpublished Works.

© 1992-1997 Dolby Laboratories, Inc. All rights reserved.

Manufactured under license from Digital Theater Systems, Inc. US Pat. No. 5,451,942 and other world-wide patents issued and pending. "DTS", "DTS Digital Surround", are trademarks of Digital Theater System, Inc.

© 1996 Digital Theater Systems, Inc. All Rights Reserved.

Names of parts and controls

Refer to the corresponding pages indicated in () for details.

Front panel

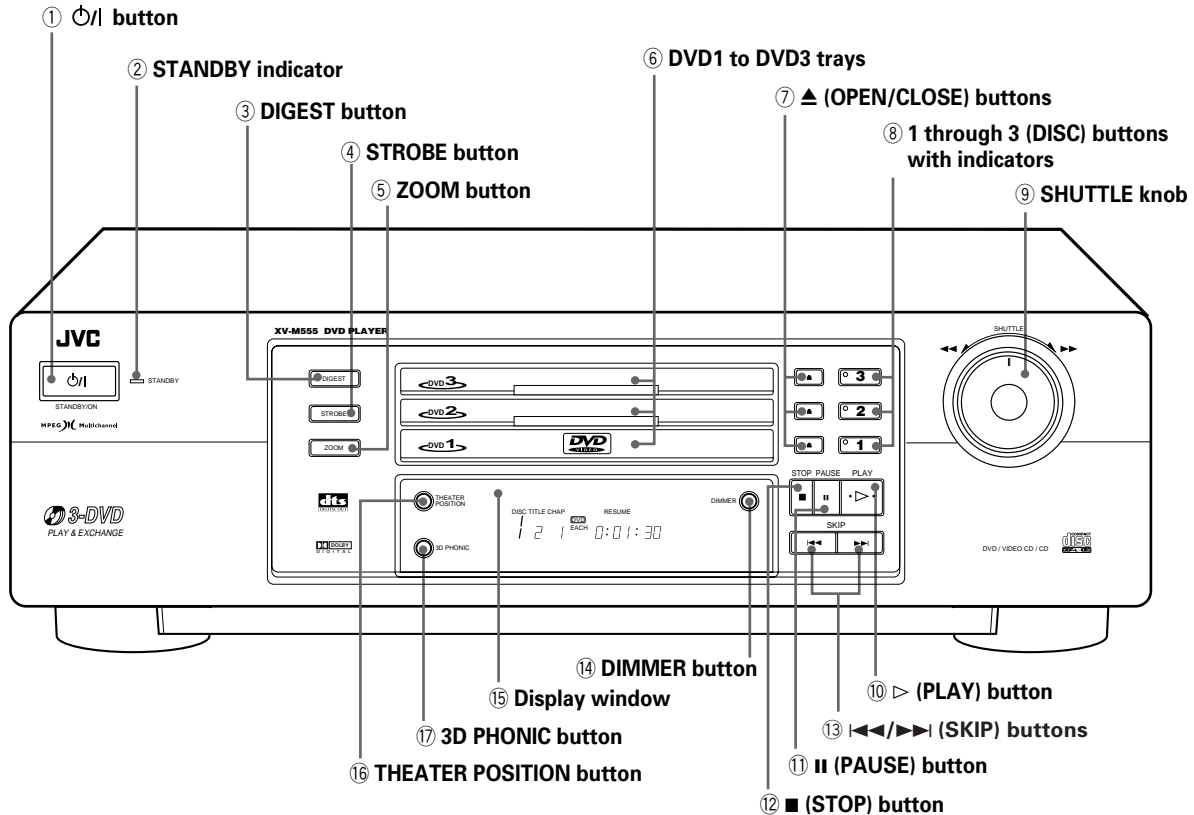

① ⏻ button (17)

Turns the unit on or off (standby).

② STANDBY indicator

Lights when the power cord is connected and the unit is on standby. When the unit is turned on, the STANDBY indicator goes off.

③ DIGEST button (for DVD/Video CD) (23)

Displays beginning scenes of each title, chapter, or track on the TV screen.

④ STROBE button (for DVD/Video CD) (24)

Displays nine continuous still pictures.

⑤ ZOOM button (for DVD/Video CD) (25)

Zoom-in for a close-up view of the scene.

⑥ DVD 1 to DVD 3 trays (17)

Used to load discs. To insert/remove discs, press the ▲ (OPEN/CLOSE) button located on the right of the tray corresponding to disc number.

⑦ ▲ (OPEN/CLOSE) buttons (17)

Used to open and close disc trays 1 to 3 respectively. When, after opening the DVD1 tray, another ▲ (OPEN/CLOSE) button is pressed, the DVD1 tray is first closed, then the other DVD tray selected is opened.

⑧ 1 through 3 (DISC) buttons with indicators (18)

Used to start playback of the disc in the tray corresponding with the number indicated on the button (these functions the same as the DISC 1 through 3 buttons on the remote control unit). While playing, the corresponding indicator blinks.

In this manual, they are sometimes called "DISC" buttons.

⑨ SHUTTLE knob (19, 25)

Performs rapid advance/reverse playback operations. Also used for slow-motion playback of a picture (for DVD/Video CD).

⑩ ▷ (PLAY) button (18)

Starts playback. Also, used as a SELECT button for the PBC of Video CDs.

Functions the same as the ▷ (SELECT) button on the remote control unit.

⑪ || (PAUSE) button (18)

Pauses playback

⑫ ■ (STOP) button (18)

Stops playback.

⑬ ◀▶ (SKIP) buttons (19)

Used to skip a chapter, title or track. Also, used for the page selection of a menu screen (for Video CD).

⑭ DIMMER button

Dims the display window.

⑮ Display window

Indicates the current status of the unit.

⑯ THEATER POSITION button (31)

Selects a picture character from 4 settings.

⑰ 3D PHONIC button (32)

Produces a simulated surround effect.

Remote control unit

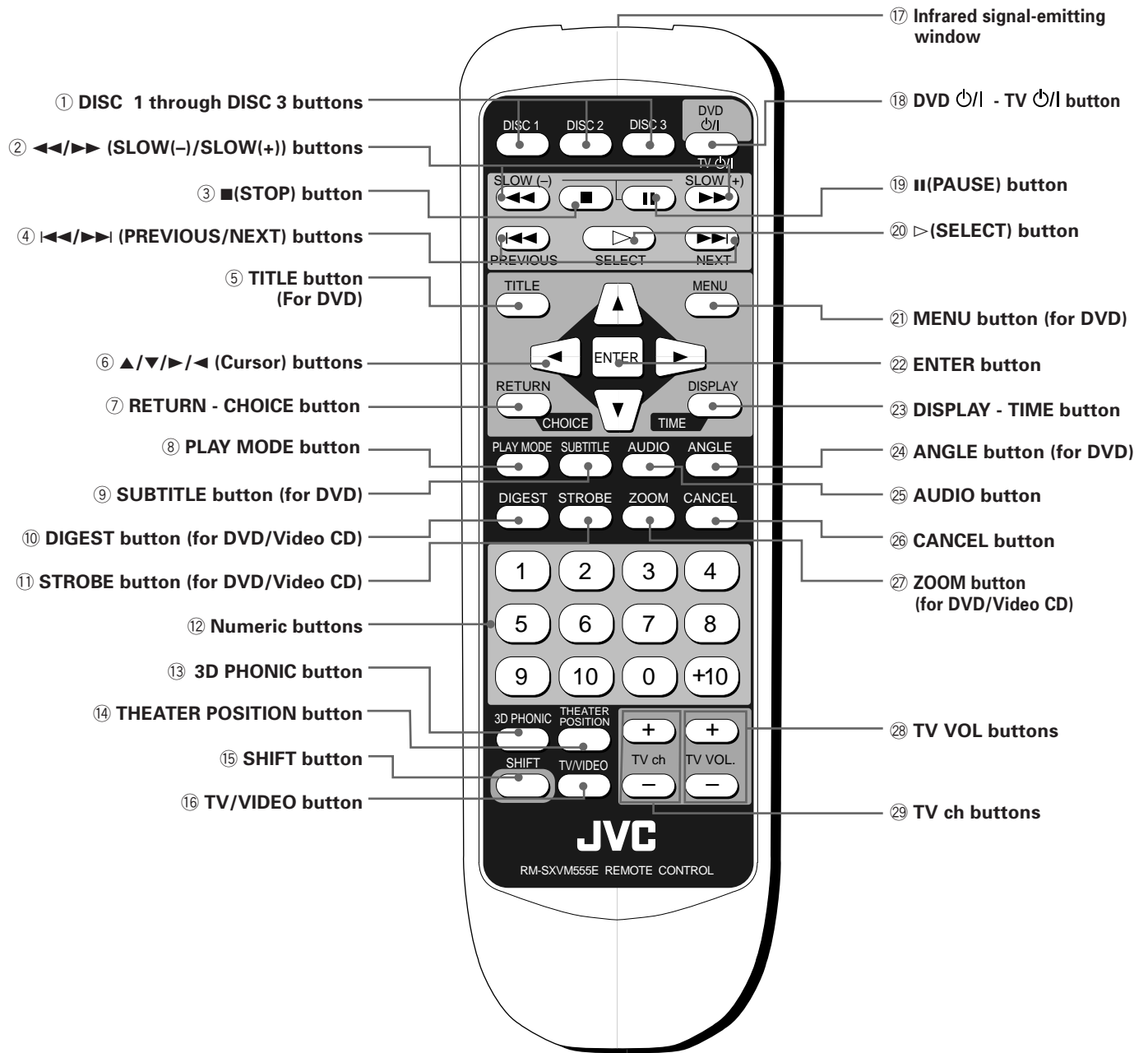

Preliminary Knowledge

- ① **DISC 1 through DISC 3 buttons (18)**
Used to start playback of the disc in the corresponding tray. Function the same as the 1 through 3 buttons on the front panel.
- ② **◀◀/▶▶ (SLOW(-)/SLOW(+)) buttons (19, 25)**
Perform rapid advance/reverse playback operations. Also used for slow-motion playback of a picture (for DVD/Video CD).
- ③ **■ (STOP) button (18)**
Stops playback.
Also used to erase all the programmed tracks for program play.
- ④ **◀◀/▶▶ (PREVIOUS/NEXT) buttons (19)**
Perform skipping a chapter, title or track.
Also used for the page selection of a menu screen (for DVD/Video CD).
- ⑤ **TITLE button (for DVD) (20)**
Displays a DVD title menu on the TV screen or monitor.
- ⑥ **▲/▼/▶/◀ (CURSOR) buttons**
Used to select an item from a menu or on-screen display, or to change the setting of an item in the on-screen display.
- ⑦ **RETURN - CHOICE button (20, 35)**
Returns to the previous menu (for DVD/Video CD). When pressed while holding down the SHIFT button, the Preference on-screen display appears on the TV screen.
- ⑧ **PLAY MODE button**
Displays an on-screen display for controlling the advanced playback functions.
- ⑨ **SUBTITLE button (for DVD) (30)**
Used to display the subtitle selection display on the TV screen, as well as used to turn the subtitle on or off.
- ⑩ **DIGEST button (for DVD/Video CD) (23)**
Displays beginning scenes of each title, chapter, or track on the TV screen.
- ⑪ **STROBE button (for DVD/Video CD) (24)**
Displays nine continuous still pictures.
- ⑫ **Numeric buttons (10)**
Mainly used to select a title/track number, or a TV channel. Also used to enter a time for the Time search and a chapter number for the Chapter search.
- ⑬ **3D PHONIC button (32)**
Produces a simulated surround effect.
- ⑭ **THEATER POSITION button (31)**
Selects a picture character from 4 settings.
- ⑮ **SHIFT button (16, 33, 35, 38)**
Used together with other keys for activating their second functions.
- ⑯ **TV/VIDEO button (16)**
Switches the TV input mode.
- ⑰ **Infrared signal-emitting window**
Point this window toward the remote sensor on the front panel when pressing buttons.
- ⑱ **DVD ⏻ - TV ⏻ button (16, 17)**
Turns the unit on or off (standby). Pressing this button while holding down the SHIFT button turns the TV on or off.
- ⑲ **⏸ (PAUSE) button (18)**
Pauses playback.
- ⑳ **▷ (SELECT) button (18)**
Starts playback. Also used as a SELECT button for PBC of Video CDs.
Functions the same as the ▷ (PLAY) button on the front panel.
- ㉑ **MENU button (for DVD) (20)**
Displays a DVD menu on the TV screen or monitor.
- ㉒ **ENTER button**
Executes the selected item in a menu or on-screen display when pressing the button.
- ㉓ **DISPLAY - TIME button (33)**
Displays the status information (only for DVD) or the time information (for all types of discs). When the time information appears, pressing this button while holding down the SHIFT button changes the time mode.
- ㉔ **ANGLE button (for DVD) (29)**
Changes camera angles during playback of a DVD containing multiple camera angles.
- ㉕ **AUDIO button (31)**
Selects the audio (for DVD/Video CD).
- ㉖ **CANCEL button (26)**
Cancels the previous settings.
- ㉗ **ZOOM button (for DVD/Video CD) (25)**
Zoom-in for a close-up view of the scene.
- ㉘ **TV VOL buttons (16)**
Adjust the TV volume.
- ㉙ **TV ch buttons (16)**
Change the TV channels.

Display window

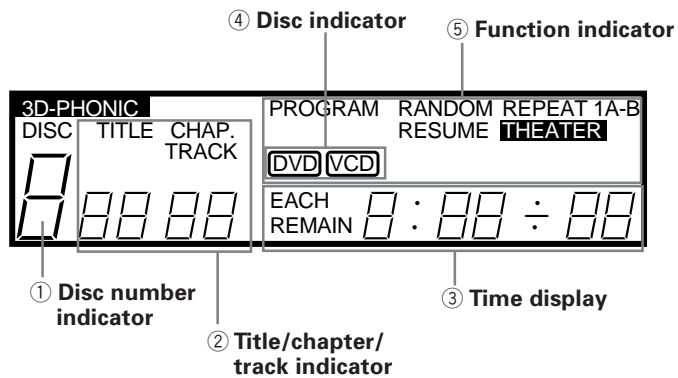

- ① **Disc number indicator**
Shows the disc number being selected.
- ② **Title/chapter/track indicator**
Displays title/chapter, or track number.
- ③ **Time display**
Shows the cumulative or remaining time of the track or disc, or the total disc time.
- ④ **Disc indicator**
Indicates the type of the disc set in the selected tray. When a DVD or Video CD disc is set, "DVD" or "VCD" is indicated. When an Audio CD is set, there is no indication.
- ⑤ **Function indicator**
Activated function indicators light up.

Rear panel

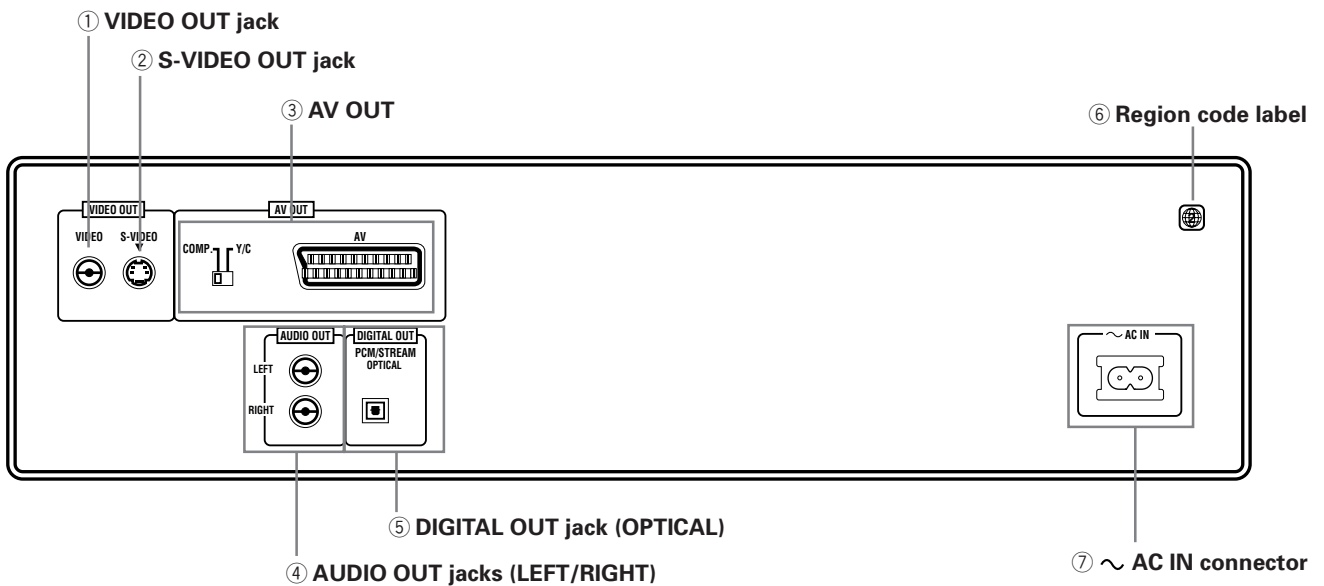

- ① **VIDEO OUT jack (12)**
Outputs a composite video signal.
- ② **S-VIDEO OUT jack (12)**
Outputs an S-video signal.
- ③ **AV OUT (13)**
Standard 21-pin SCART connector feeds the video and audio signal. The video output signal is selected from composite (COMP) and Y/C by the COMP-Y/C switch. The audio signal is same as AUDIO OUT.
- ④ **AUDIO OUT jacks (LEFT/RIGHT) (12)**
Outputs stereo analog audio signals.
- ⑤ **DIGITAL OUT jack (OPTICAL) (14)**
Outputs digital audio signals. Only an optical connector is provided.
- ⑥ **Region Code label (11)**
Shows Region Code number.
- ⑦ **~ AC IN connector (14)**
Connects to the wall outlet using the supplied AC power cord.

Operational Principles

On-screen displays

The unit provides several on-screen displays. With some displays, you can set or select preferences or functions, while the others are display-only.

Opening displays

The Opening display appears automatically in some conditions. At the bottom, the following information are indicated depending on the unit's status.

- NOW READING: The unit is now reading the disc information (TOC).
- REGION CODE ERROR!: The DVD disc loaded cannot be played because the region code of the disc does not match the unit.
- CHANGE → DISC 1: The unit is now changing the disc tray to DISC 1.
- OPEN: The selected tray is now opening.
- CLOSE: The selected tray is now closing.

Preference displays

When the unit is stopped, pressing the RETURN-CHOICE button while holding the SHIFT button accesses the preference display for setting the preferences. There are four pages: LANGUAGE, AUDIO, DISPLAY and SYSTEM as shown in the right. See page 35 for detailed information.

Opening display



LANGUAGE

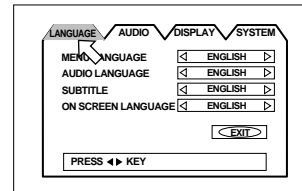

AUDIO

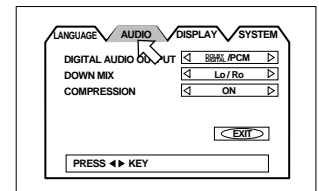

DISPLAY

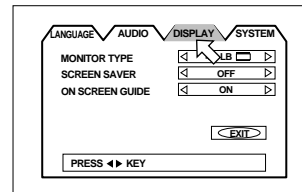

SYSTEM

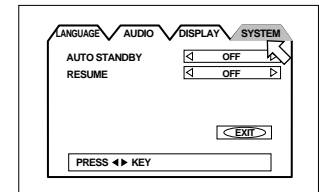

PARENTAL LOCK displays

When no disc is inserted or a DVD disc is stopped in the selected disc tray, pressing the ENTER button while holding down the SHIFT button accesses the PARENTAL LOCK display in which you can set the level for limiting playback. See page 39 for detailed information.

PARENTAL LOCK

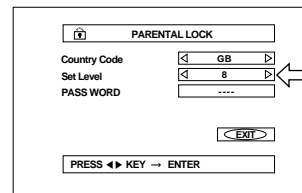

Play mode displays

Pressing the PLAY MODE button accesses the play mode display in which you can control playback functions. Different displays appear depending on the disc type and the unit's status.

While stopped

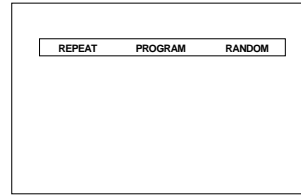

During DVD playback

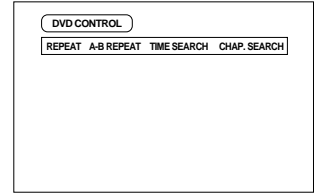

During Audio CD playback

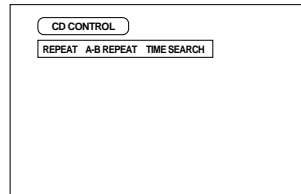

During Video CD playback

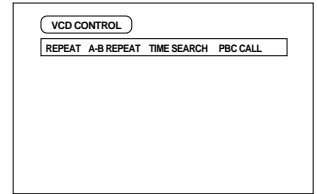

Status displays

Pressing the DISPLAY-TIME button during playback accesses the status display.

For a DVD disc, pressing the DISPLAY-TIME button toggles between the DVD function status display, and the disc/time display and off.

For a Video CD or Audio CD disc, pressing the DISPLAY-TIME button switches the disc/time display on and off.

DVD function status

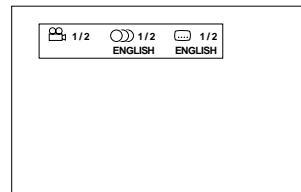

Disc/time (DVD)

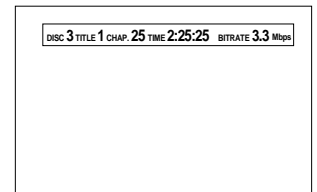

Disc time (Audio CD/Video CD without PBC)

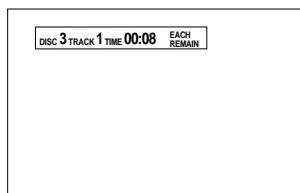

Disc time (Video CD with PBC)

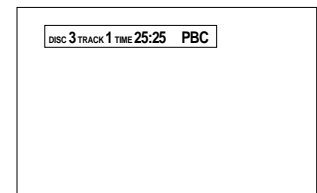

To prevent the monitor from burning out [SCREEN SAVER]

A television monitor screen may be burned out if a static picture is displayed for a long time. To prevent this, the unit automatically activates the screen saver function if a static picture, such as an on-screen display or menu, is displayed for over 5 minutes.

- Pressing any button on the unit or the remote control unit will release the screen saver function and return to the previous display.
- You can select one of several screen saver modes available (see page 38).
- The screen saver function is not activated during Audio CD playback or after stopping Audio CD playback.

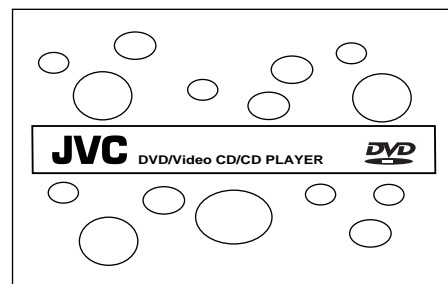

On-screen guide icons

During DVD playback, you may see icons displayed over the picture. These have the following meanings.



: Displayed at the beginning of a scene recorded from multiple angles. (See page 29.)





: Displayed at the beginning of a scene recorded with multiple audio languages. (See page 31.)



: Displayed at the beginning of a scene recorded with multiple subtitle languages. (See page 30.)

You can set the unit not to display on-screen icons above via the preference settings described on page 38.

About invalid operation icon

When you press a button, if the unit does not accept its operation,  appears on your television screen. Operations are occasionally unacceptable even if  is not displayed.

Note that some operations may not be accepted. For example, some discs may not allow rapid advance/reverse or slow-motion playback.

How to use numeric buttons

To select a track/title number

- **To select a number between 1 and 10**
Press the corresponding button for the number.
- **To select a number higher than 10**
Use the +10 button.

Examples:

To select 13 +10 → 3

To select 34 +10 → +10 → +10 → 4

To select 40 +10 → +10 → +10 → 10

To enter a time or chapter number

The method for entering a time for Time search or chapter number for Chapter search is different from above. See the corresponding sections in this manual for the details.

To select a TV channel.

Press the corresponding numeric buttons (between 0 and 9) while holding down the SHIFT button.

About discs

Playable disc types

Playable and non-playable disc types are as follows:

Playable discs

| DVD VIDEO | Video CD | Audio CD |
|---|---|--|
|  |   |  |

The DVD Logo is a trademark.

- DVD players and DVD discs have their own Region Code numbers. This unit only can play back DVD discs whose Region Code numbers include "2".

Examples of playable DVD discs:



This unit accommodates discs for the PAL system.

Non-playable discs

DVD-ROM, DVD-RAM, DVD Audio, DVD-R, DVD-RW, CD-R, CD-ROM, PHOTO CD, CD-RW, CD-EXTRA, CD-G, CD-TEXT

- Playing back discs listed as "Non-playable discs" in the table above may generate noise and damage speakers.
- This unit can play back audio recorded in CD-G, CD-EXTRA and CD-TEXT discs.

NOTE

- With some DVD and Video CD discs, you may not be able to control them according to the instructions described in this manual, because of the contents of the disc.

Disc structure

A DVD disc is comprised of "titles," while an Audio CD, Video CD is comprised of "tracks." Each title may be divided into some "chapters." For example, if a DVD disc contains some movies, each movie may have its own title number, and each movie may be divided into some chapters. In a DVD karaoke disc, each song usually has its own title number and does not have chapters. In general, each title has independent content, while each chapter in the same title has continuity.

(Example: DVD disc)

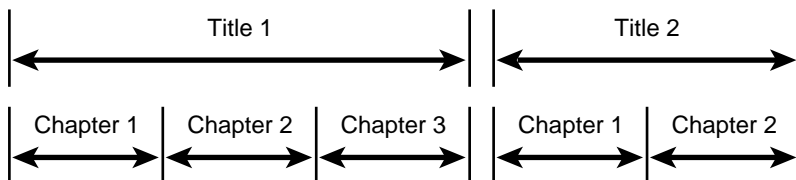

(Example: Audio CD/Video CD)

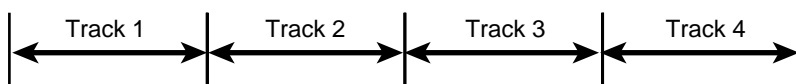

Connections

*In the following description, "TV" may be substituted with "monitor" or "projector."

*Before using the unit, you have to connect the unit to a TV and/or amplifier.

Before making any connections

- Do not connect the AC power cord until all other connections have been made.
- Since different components often have different terminal names, carefully read the instructions supplied with the component you are going to connect.

To connect to a TV

You can enjoy using the unit by simply connecting it to a TV. To improve audio sound quality, connect the audio outputs to your separate audio equipment. (See the following pages.)

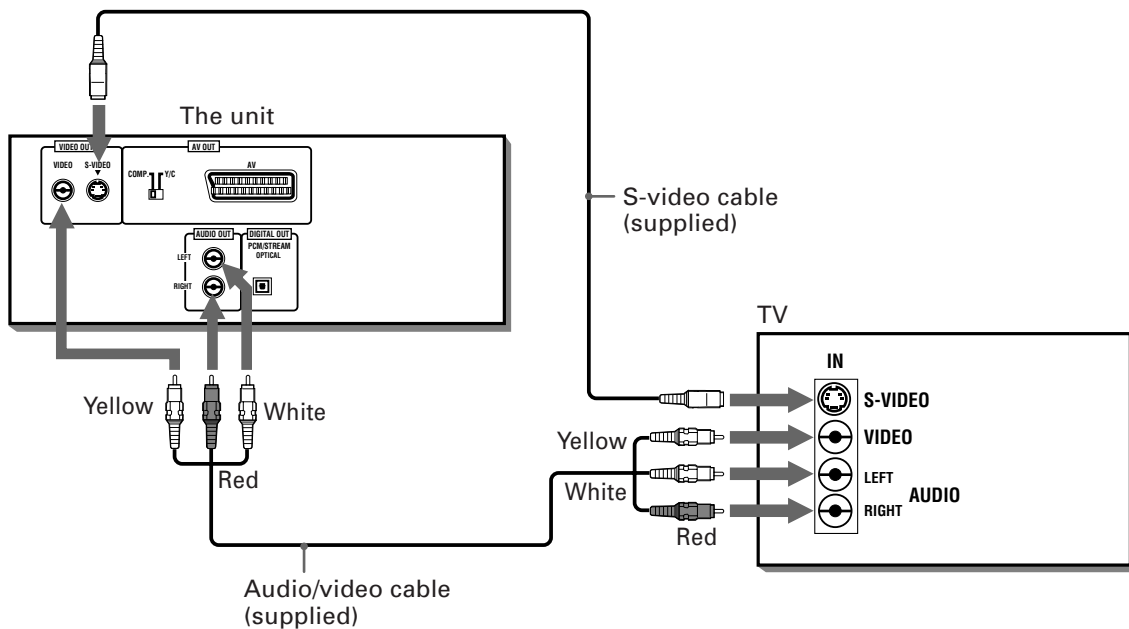

Connect the unit to a TV equipped with stereo audio input and video input jacks using the supplied audio/video cables.

- If your TV has a monaural audio input instead of stereo, you need to use an optional audio cable which converts stereo audio output to monaural.
- If your TV has an S-video input, you should connect it with the S-VIDEO output of the unit using the supplied S-video cable in addition to the (standard) video connection to get better picture quality.

NOTES

- Connect VIDEO OUT of the unit directly to the video input of your TV. Connecting VIDEO OUT of the unit to a TV via a VCR may cause a monitor problem when playing back a copy-protected disc.
- Do not connect the unit to an NTSC television. Connect it to a PAL television.

To connect to a TV with the SCART connector

You can enjoy using the unit by simply connecting it to your television set with a 21-pin SCART cable. To hear audio sound with better quality, connect the audio output to your audio equipment. (See below.)

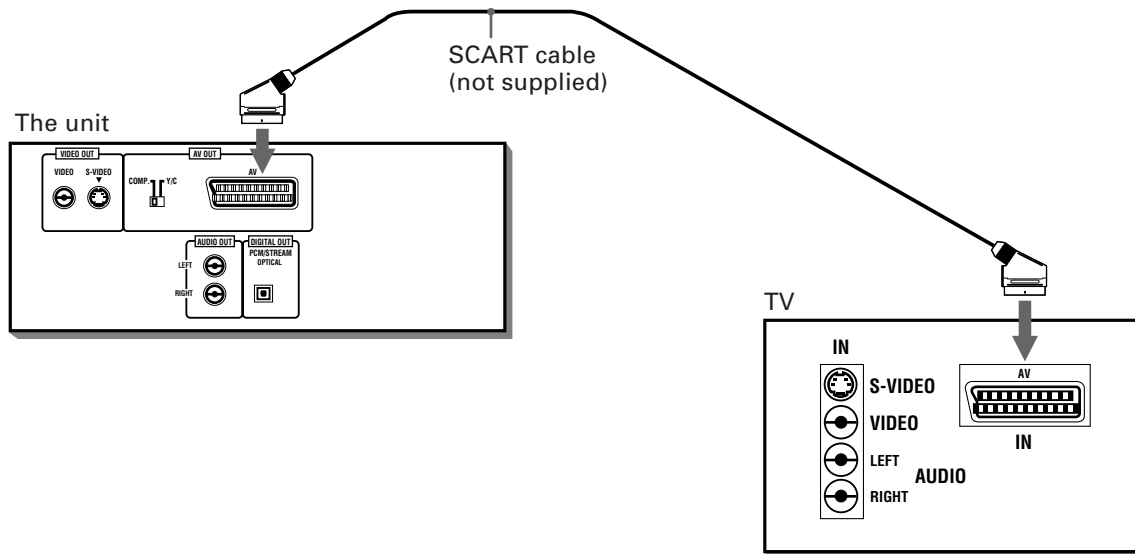

Connect the unit's AV OUT connector with your TV's SCART connector using an optional SCART cable.

- If your TV's SCART connector is compatible only with the regular video signal, set the COMP.-Y/C switch to "COMP.".
- If your TV's SCART connector is compatible with the Y/C signal, set this switch to "Y/C". You will enjoy better-quality pictures.

NOTE

- Do not connect the unit to a NTSC television. Connect it to a PAL television.

To connect to an audio amplifier or receiver

You can enjoy high-quality audio by connecting the unit's audio output to your amplifier or receiver.

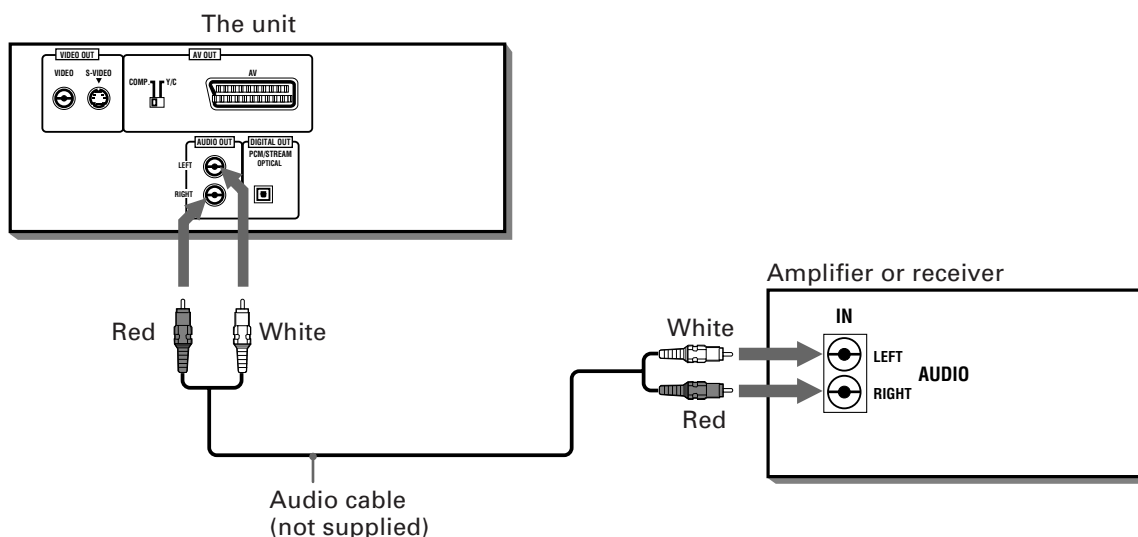

- Connect the unit's AUDIO OUT to any line-level inputs (such as AUX, DVD, CD, etc.) of an audio amplifier or receiver.

To connect to audio equipment with a digital input

You can enhance the sound quality by connecting the unit's DIGITAL OUT (optical) to the digital input of an amplifier, DAT or MD by using an optional digital cable. The digital stereo audio signal from a disc is directly transferred. If you connect the unit to a Dolby Digital, DTS or MPEG multichannel decoder or an amplifier with a built-in decoder by using an optional digital cable, you can enjoy high-quality surround sound.

When you make the digital connection, also make the analog connection, because, depending on the disc type, no audio may be reproduced from the DIGITAL OUT.

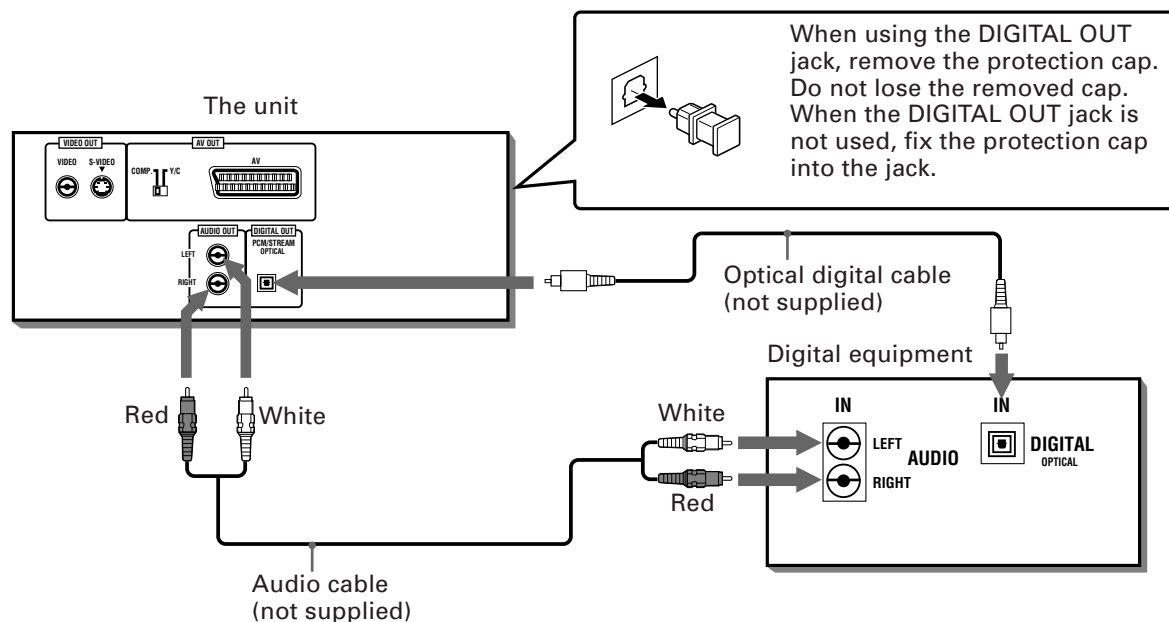

- For digital connection, connect the unit's DIGITAL OUT (optical) to the digital input of audio equipment using an optional digital cable.

NOTES

- When you connect the unit's DIGITAL OUT to digital audio equipment, before using, make the "DIGITAL AUDIO OUTPUT" setting in the "AUDIO" page of the preference display correctly according to the connected audio equipment. If the "DIGITAL AUDIO OUTPUT" is not set correctly, loud noise may be generated from speakers, causing damage to your speakers. See "DIGITAL AUDIO OUTPUT" on page 36.
- With the digital connection, the unit's settings for COMPRESSION and DOWN MIX in the AUDIO page of the preference display are invalid. Settings for these items must be made from the decoder.

To connect the power cord

When all the audio/video connections have been made, insert the smaller plug of the supplied AC power cord to the unit's AC IN connector, then insert the other end to the wall outlet. Make sure that plugs are inserted firmly. The STANDBY indicator lights and setup is completed.

Warning

- Disconnect the power cord if you are not going to use the unit for a long time.
- Disconnect the power cord before cleaning the unit.
- Disconnect the power cord before moving the unit.
- Do not connect or disconnect the power cord with wet hands.
- Do not pull the power cord when disconnecting it, as this may damage the cord and cause fire, electric shock, or other accidents.

Caution

- Do not damage, alter, twist, or pull the power cord, as this may cause fire, electric shock, or other accidents.
- To prevent any accidents or damages caused by an unsuitable AC power cord, only use the supplied power cord. If the cord is damaged, contact a dealer and get the new power cord.
- Do not put anything heavy, or the unit, on the power cord, as this may cause fire, electric shock, or other accidents.

Using the remote control unit

Using the remote control, you can operate not only all the functions of the unit but also basic functions of your TV.

To install batteries in the remote control unit

The battery compartment is located on the back of the remote control unit.

- 1 Press down on the point shown by the arrow at the top of the compartment cover, and pull up the cover to open the compartment.

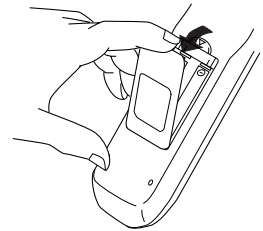

- 2 Place the two accessory R6P (SUM-3)/AA(15F) batteries in the remote control according to the polarity markings (“+” and “-”) inside the compartment and on the batteries.

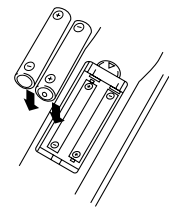

- 3 Place the cover over the compartment, and press down lightly.

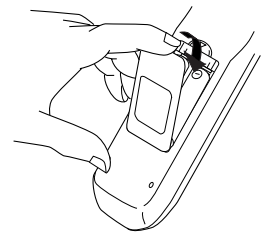

- The batteries will last about six months with normal use. If the functions of the remote control become erratic, replace the batteries. See below for more information.

Precautions for the safe use of batteries

Observe the following precautions for the safe use of batteries. If they are used improperly their life will be shortened, they may burst or their contents may leak.

Precaution

- Remove the batteries from the remote control if it is not going to be used for a long period of time.
- Remove dead batteries and dispose of them properly.
- Never leave dead batteries lying around, take them apart, mix them with other refuse, or throw them into an incinerator.
- Never touch liquid that has leaked out of a battery.
- Do not mix new and old batteries, or batteries of different types, when replacing them.

To use the remote control unit for TV operation

You can operate your TV from the remote control unit.

Setting the remote control signal for operating your TV.

- 1 Holding down TV/VIDEO, enter the manufacturer code of your TV listed below by using the numeric buttons (0 - 9). Do not release TV/VIDEO. Keep holding it until the next step is completed.

Manufacturer code list





| No. | Manufacturer |
|-----|--------------|
| 01 | JVC |
| 02 | JVC |
| 03 | JVC |
| 04 | JVC |
| 05 | THOMSON |
| 06 | FERGUSON |
| 07 | PHILIPS |
| 08 | GRUNDIG |
| 09 | SONY |
| 10 | PANASONIC |
| 11 | ITT |
| 12 | MIVER |
| 13 | HITACHI |
| 14 | TOSHIBA |
| 15 | MITSUBISHI |
| 16 | FINLUX |
| 17 | NOKIA |
| 18 | SHARP |
| 19 | SAMSUNG |
| 20 | FUNAI |
| 21 | GOLDSTAR |
| 22 | NEC |



Example:

To enter the manufacturer code "01":
Press "0" then "1."

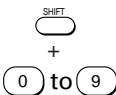
- 2 Press  while holding down TV/VIDEO.

The following buttons can be used for operating the TV:

| | |
|---|--|
|  | Turns the TV on or off. |
|  | Changes the TV channels. |
|  | Adjusts the TV volume. |
|  | Selects the TV channels *For some TVs, pressing "+10" while holding down SHIFT functions as the "RETURN," and pressing "10" while holding down SHIFT functions as the "_ / _ _" button. |
|  | Switches input mode (either TV or VIDEO). |

- 3 Try to operate your TV by pressing DVD  - TV  while holding SHIFT. If your TV turns on or off, you have successfully set the control signal.

NOTES

- The remote control unit is initially set for operating a JVC TV.
- If there is more than one code listed for the manufacturer of your TV, try them one by one until you succeed.

Basic operations

In the following description, the buttons on the remote control unit are used, however, you may use the corresponding buttons on the front panel of the unit if available.

Turning on/off the unit

Press \odot/I on the front panel or press DVD \odot/I - TV \odot/I on the remote control unit.

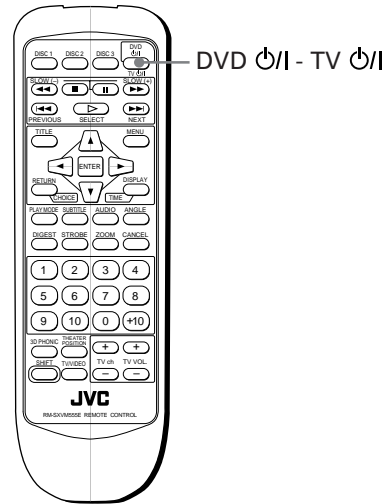
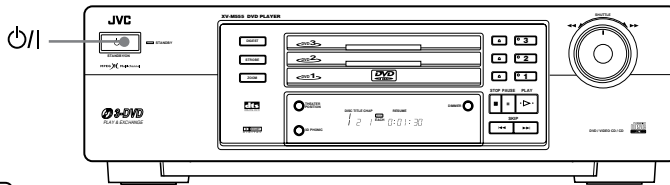

Hints

- You can turn on the unit by pressing the \triangleright (PLAY) button or any one of 1 through 3 buttons on the front panel or, the \triangleright button or any one of DISC 1 through 3 buttons on the remote control unit. In this operation, the unit starts playback if the disc is set in the selected tray.
- You can also turn on the unit by pressing any one of the \blacktriangle (OPEN/CLOSE) buttons on the front panel.

NOTE

- Even if you press the \odot/I or DVD \odot/I - TV \odot/I button to turn off the unit, the unit is not disconnected from the AC power source as long as it is connected to the wall outlet. This state is called the standby mode. In this state, the unit is designed to consume a very small quantity of power.

Inserting and removing discs

Up to three discs can be set in the unit. You may insert a disc into any of the disc trays 1 through 3.

- 1 Press \blacktriangle (OPEN/CLOSE) located on the right of the tray corresponding to disc number. The corresponding disc tray opens.
- 2 Place the disc in the tray.

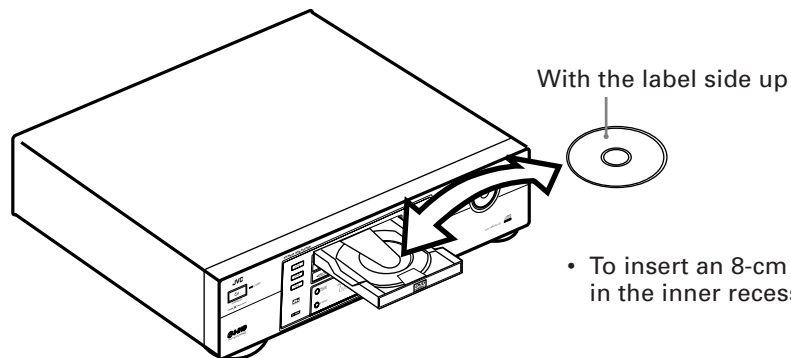

- 3 Press \blacktriangle (OPEN/CLOSE) to close the disc tray.

Hints

- If you press \blacktriangle (OPEN/CLOSE) for the disc being played, the unit stops and then opens the tray.
- You can change, insert or remove the disc by pressing \blacktriangle (OPEN/CLOSE) for the disc tray which is not in use for playback while the disc in the other tray is being played, without stopping play.

NOTES

- The unit can playback DVD, Audio CD, and Video CD discs only. Do not load other disc types. For details about playable disc types, see page 11.
- When loading a disc in the tray, be sure to position the disc inside the recess. Otherwise, the disc may be damaged when the tray is closed, and the disc may not be removed from the unit.

Basic playback

Now you can play a disc. First, let's enjoy simple playback according to following procedure.

To start playback

DVD Audio CD Video CD

Press ▷,
or

press one of the DISC buttons (1 through 3) on the front panel or DISC 1 through 3 on the remote control unit.

The unit starts playback from:

- the selected disc indicated in the display window when pressing ▷
or
- the corresponding disc when pressing a DISC button.

The indicator on the DISC button (1 - 3) on the front panel corresponding to the disc being played flashes.

In both cases above, the unit basically plays back all discs in the trays continuously in the following sequence and then stops.

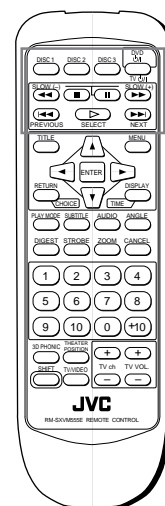

Basic control buttons

- With a DVD disc or a Video CD disc with PBC function, the unit does not automatically playback the next disc. To playback the next disc in such a case, press the corresponding DISC button.

NOTES

- The 1 through 3 buttons on the front panel function the same as the respective DISC 1 through 3 buttons on the remote control unit.
- During playback, the display window shows the disc number and the title/chapter or track number being played.
- When the resume point is memorized, the unit starts playback from that point instead of the beginning. See page 19.
- With Video CD discs with PBC control or some DVD discs, the menu display may appear on the TV screen after starting playback. In such a case, select an item to be played back from the menu.
For operation using a menu, see page 20.
- With some DVD discs, the unit starts playback automatically after inserting the disc.

To stop playback completely

DVD Audio CD Video CD

Press ■.

The unit stops playback.

To stop playback temporarily

DVD Audio CD Video CD

Press ⏸.

The unit pauses playback. To continue playback, press ▷.

To advance or reverse play rapidly while monitoring

DVD

Audio
CDVideo
CD

■ During playback

From the remote control unit

Press ►► or ◀◀.

Pressing ►► advances playback rapidly, while pressing ◀◀ reverses playback rapidly. Each time you press the button, advance or reverse playback speed increases. To return to normal playback, press ▷.

From the front panel

Use the SHUTTLE knob.

To advance playback rapidly, turn the shuttle knob to the right and hold, and to reverse play rapidly, turn the shuttle knob to the left and hold. When you release the shuttle knob, the unit returns to normal playback. The playback speed changes according to the amount you turn the shuttle knob.

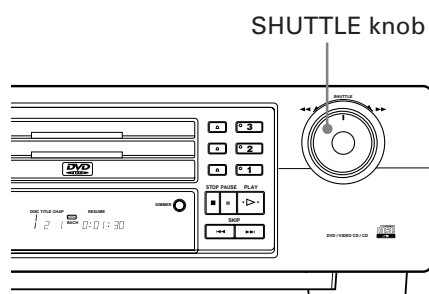

To locate the beginning of the scene or song

DVD

Audio
CDVideo
CD

■ During playback

Press ►►| or |◀◀.

Press |◀◀ to locate the beginning of the current chapter, title, or track, and press ►►| to locate the beginning of the next chapter, title, or track.

NOTE

When you play a Video CD disc with the PBC function or a DVD disc, the unit may locate a different place, but it will generally locate the beginning of the title or chapter or track.

To resume playback

DVD

Video
CD

When RESUME on the SYSTEM page of the preference display is set to ON, the unit memories the position on a disc where you interrupt playback last time and resumes playback from that position next time you press ▷. (See Page 38.)

When the unit memorizes the resume position, "RESUME" is displayed in the display window:

■ When the disc you interrupted playback last time remains selected and stopped

Press ▷.

The unit starts playback from the position where you interrupted playback last time.

● To clear the memory of the resume position

Take out the disc from the unit, or press ■ while stopped.

NOTES

- Pressing a DISC button (1-3) does not activate the resume function. It always starts playback from the beginning.
- The resume function does not work with Audio CD discs.
- The resume function does not work if RESUME on the SYSTEM page of the preference display is set to OFF.
- You can store the position where you interrupt playing by pressing ■, as well as by turning the unit off.
- In the case of a Video CD disc with PBC function, the unit may resume playback from a point slightly earlier than the resume point you stored.
- The resume function does not work in the program or random mode.

Advanced operations

When you operate the functions described below while stopped, make sure that the desired disc number is selected by checking the the disc indicator in the display window. If it is not selected, press the corresponding DISC button to start playback and then press ■.

Playing from a specific position on a disc

You can play a disc from the selected track, title or chapter, or from the specified time.

To locate a desired scene from the DVD menu



DVD discs generally have their own menus which show the disc contents. These menus contain various items such as titles of a movie, names of songs, or artist information, and display them on the TV screen. You can locate a desired scene by using the menu.

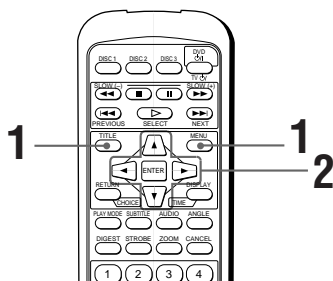

■ Whenever a DVD disc is loaded

1 Press MENU or TITLE.

The menu appears on the TV screen.



About menu

Normally, a DVD disc which contains more than one title may have a "title" menu which lists the titles. In this case, the menu appears on the TV screen by pressing the TITLE button. Some DVD discs may also have a different menu which appears by pressing the MENU button.

Example

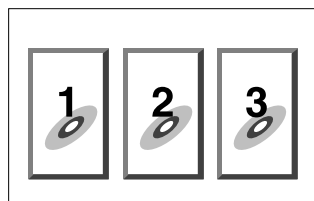

See the instructions of each DVD disc for its particular menu.

2 Use CURSOR ◀/▶/▲/▼ to select a desired item, then press ENTER.

The unit starts playback of the selected item.



With some discs, you can also select items by entering the corresponding number using the numeric buttons, which may cause the unit to automatically start playback.

NOTES

- When appears on the TV screen by pressing TITLE in step 1:
The disc does not have a menu listing the titles.
- When appears on the TV screen by pressing MENU in step 1:
The disc does not have a menu.
- The MENU button does not work while stopped.

To locate a desired scene from the menu of the Video CD with PBC



Some Video CD discs are compatible with the PBC function. PBC is an abbreviation of "PlayBack Control." A Video CD disc recorded with PBC has its own menus, such as a list of the songs of the disc and items recorded on the disc. You can also locate a specific scene by using the menu.

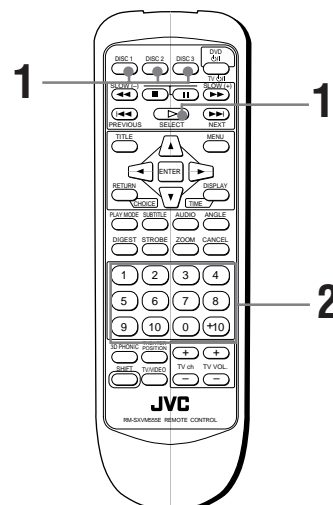

■ When a Video CD disc with PBC is stopped

1 Press ▷ or the corresponding DISC (1-3) button.

A disc menu appears on the TV screen (The PBC function is activated).

Example:

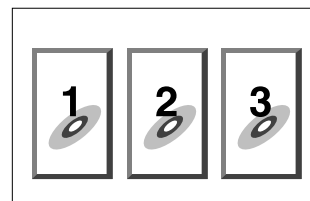

"Pbc" is indicated in the display window on the front panel.

2 Use the numeric buttons to select the desired number of the item.

- See page 10 for details about how to use the numeric buttons.

Playback starts from the selected item.

You can return to the menu by pressing RETURN.

When "NEXT" or "PREVIOUS" appears on the TV screen, the unit generally works as follows:

- Pressing ►► advances to the next page.
- Pressing ◀◀ returns to the previous page.
- * The method of the operation is different depending on the disc.

Hints

- To activate the PBC function when a PBC-compatible Video CD disc is being played back without the PBC function, press ■ then press ▷.
- You can also activate the PBC function using the play mode menu display as follows.
 1. Press PLAY MODE.
 2. Use the ◀/▶ buttons to move to [PBC CALL], then press ENTER.
- If you want to playback a PBC-compatible Video CD disc without activating the PBC function, start playback by using the numeric buttons instead of the ▷ button. See the next paragraph.

To locate a desired title or track directly

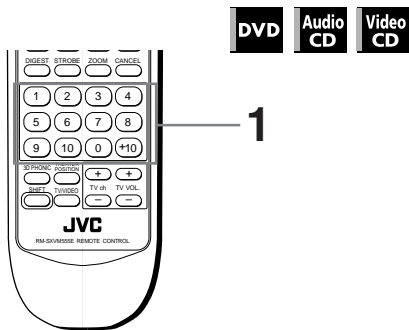

You can play a desired title for DVDs or track for Audio CD/Video CD.

- For DVD: While stopped
- For Audio CD: Whenever an Audio CD disc is loaded
- For Video CD: During playback without PBC function or while stopped

1 Use the numeric buttons to select the desired title or track number.

- See page 10 for details about how to use the numeric buttons.

The selected title or track number appears in the display window on the front panel.

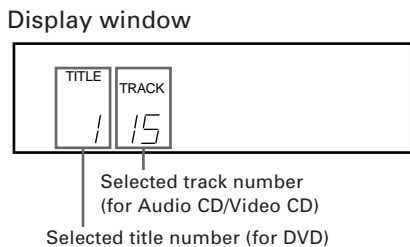

The unit starts playback from the selected title or track.

NOTES

- When ⊘ appears on the TV screen. The title or track you have selected is not contained in the disc.
- This function does not work during Video CD playback with PBC function

To locate a desired chapter or track using ►► or ◀◀

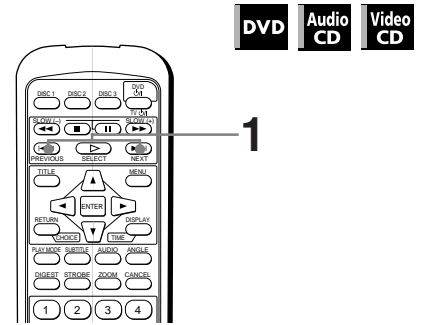

- For DVD: During playback
- For Audio CD: During playback
- For Video CD: During playback without PBC function

1 Press ►► or ◀◀.

The selected chapter or track number appears in the display window on the front panel.

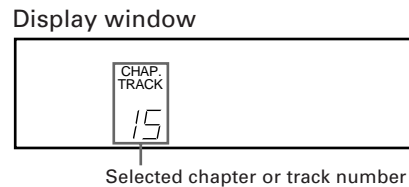

- To skip to a succeeding track, press ►► once or repeatedly until the desired track appears in the display.
- To skip to beginning of the current track, press ◀◀ once.
- To skip to a preceding track, press ►► repeatedly until the desired track appears in the display.

NOTES

- This function may not work with some DVD discs.
- This function does not work during Video CD playback with PBC function

To locate a desired scene by specifying the chapter number [CHAP. SEARCH]



If the current title of a DVD disc being played is divided into chapters, you can skip to a desired chapter by specifying the chapter number using the on-screen display.

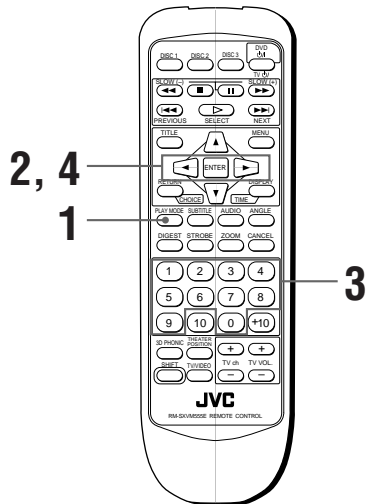

■ During DVD playback

1 Press PLAY MODE.

The DVD play mode menu is superimposed on the TV screen.

2 Use CURSOR ◀▶ to move to [CHAP. SEARCH], then press ENTER.

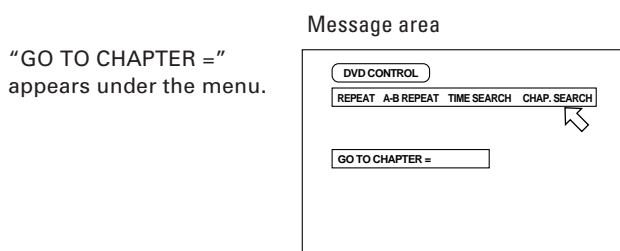

3 Use the numeric buttons (0 ~ 9) to enter the desired chapter number.

Example:

To select chapter number 8: Press "8" → ENTER.

To select chapter number 37: Press "3" → "7" → ENTER.

4 Press ENTER.

The unit starts playback from the selected chapter.



The "10" and "+10" buttons are not used in this function.

NOTES

- When the chapter number is incorrect in step 3:
Overwrite the incorrect number with the correct number.
- When  is displayed in the TV screen in step 4:
The chapter you have selected is not contained in the disc, or chapter search does not work on the disc.
- With some discs, the unit automatically starts searching for the chapter after entering the chapter number in step 3.
- To turn off the play mode menu:
Press PLAY MODE.

To locate a desired position in the current title or track [TIME SEARCH]



You can play a disc from the desired position by specifying the elapsed time from the beginning of the current title or track using the TIME SEARCH function. Note that some DVD discs do not contain time information, and the TIME SEARCH function cannot be used.

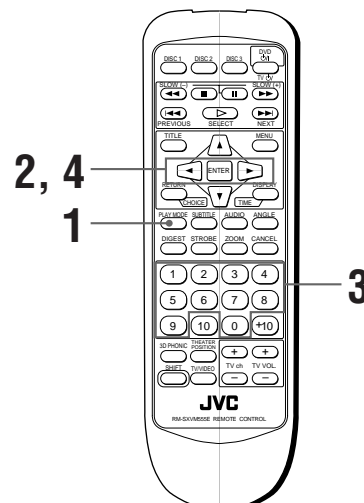

- For DVD: During playback
- For Audio CD: During playback
- For Video CD: During playback without PBC function

1 Press PLAY MODE.

The play mode menu appears on the TV screen.

2 Use CURSOR ◀▶ to move to [TIME SEARCH], then press ENTER.

"GO TO" appears under the menu.

3 Use the numeric buttons (0 ~ 9) to enter the time.

You can specify the elapsed time of the current title or track to set the location which you want to playback from.

4 Press ENTER.

The unit starts playback from the specified time.

(for DVD)

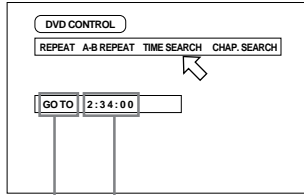

Message area Selected time

(for Audio CD)

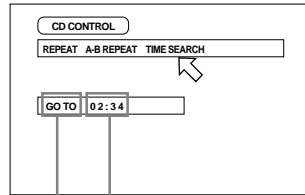

Message area Selected time

Hints

- "10" and "+10" buttons are not used in this function.
- You can specify the time in hour/minute/second format for DVD discs, and in minute/second format for Audio and Video CD discs.

(for Video CD)

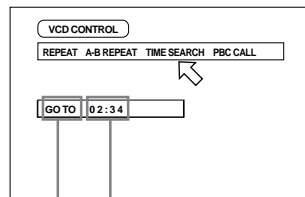

Message area Selected time

Example (for DVD):

To playback from 2(H):34(M):00(S)

GO TO _ : _ : _

↓ Press "2".

GO TO 2 : _ : _

↓ Press "3".

GO TO 2 : 3 _ : _

↓ Press "4".

GO TO 2 : 3 4 : _

↓

Press ENTER.

You do not have to press "0" to enter the trailing zeros (for the last two digits in the example above). Of course, it is possible to enter them.

- When you make a mistake

Move the cursor to the incorrect value, then press the correct button to re-select the value.

GO TO 2 : 3 5 : _

↓ Press CURSOR ←.

GO TO 2 : 3 _ : _

↓ Press "4".

GO TO 2 : 3 4 : _

NOTES

- When  appears on the TV screen in step 2:
The time you have selected is not contained on the disc, or the time search function does not work on the disc.
Also note that the time search function does not work during Video CD playback with the PBC function.
- To turn off the play mode menu:
Press PLAY MODE .

To locate a desired scene from the opening scene digest display [DIGEST]



The unit can display the opening scene of each title or chapter on a DVD or each track of a Video CD. You can select a desired scene from those displayed on the TV screen.

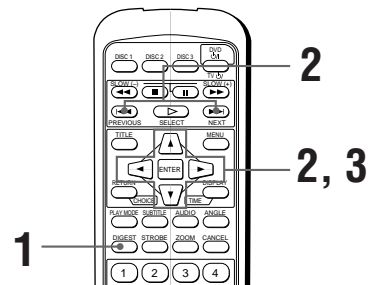

- For DVD: While stopped or during playback
- For Video CD: While stopped or during playback without PBC function.

If you use the Digest function while stopped, make sure that the disc number indicator on the front-panel display shows the desired number. If it does not, select the disc before operating the following procedure by pressing the corresponding DISC (1 - 3) button to start playback, then press ■.

1 Press DIGEST.

Up to nine opening scenes are displayed.

- While a DVD disc is stopped:
The opening scene of each title appears on the TV screen.
- During DVD disc playback:
The opening scene of each chapter in the current title appears on the TV screen.
- When a Video CD disc is loaded:
The opening scene of each track appears on the TV screen .



2 Use CURSOR ◀/▶/▲/▼ or ◀◀/▶▶ to select the desired scene.

The selected scene is indicated by .

If there are more than 9 scenes, the digest screen will have more than one page. In this case, pressing CURSOR ▶ or ▶▶ when selecting the lower right scene advances to the next page, while pressing CURSOR ◀ or ◀◀ when selecting the upper left scene returns to the previous page.



Selected scene

Hints

When there is more than one digest page, after pressing DIGEST, pressing ▶▶ before all 9 scenes of the first page appear on the TV screen will advance to the next page. Similarly, pressing ◀◀ before all the scenes of the second or latter page appear on the TV screen will return to the previous page.

3 Press ENTER.

The unit starts playback from the selected title or track.

NOTE

- With some discs, depending on the contents, it may take some time until all the scenes appear on the screen.

Special picture playback

The unit provides special picture playback functions including Frame-by-frame, Strobe, Slow-motion and Zoom.

To advance a still picture frame-by-frame

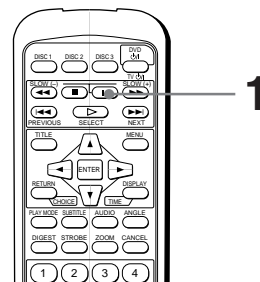

■ While paused (still)

1 Press **II**.

Each time you press **II**, the still picture advances to the next frame.

Pressing ▶ returns to the normal playback mode.

To display still pictures [STROBE]

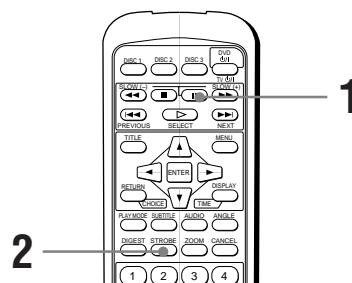

■ During playback

1 At the point you want to view as continuous photographs, press **II**.

The unit pauses playback.

2 Press STROBE.

Nine continuous still pictures appear on the TV screen.

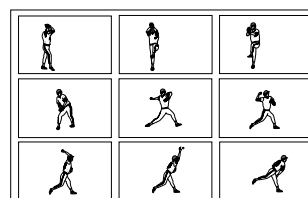

Hints

Pressing **II** when the nine still pictures appear will advance to the next nine still pictures.

• **To cancel strobe play**

Press STROBE.

NOTES

- Pressing and holding **II** for more than 1 second also activates the Strobe function.
- If you press STROBE during playback, nine still pictures also appear but they advance in realtime.

To playback in slow-motion [SLOW]



■ During playback

From the remote control unit

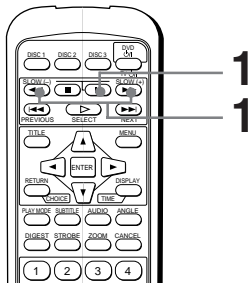

1 Press **II**, then press **▶▶** or **◀◀**.

To play forward slow-motion, press **▶▶**, and to play reverse slow-motion (for DVD discs only), press **◀◀**. First, the unit plays the slowest speed, and each time you press these buttons, the playback speed increases.

From the front panel

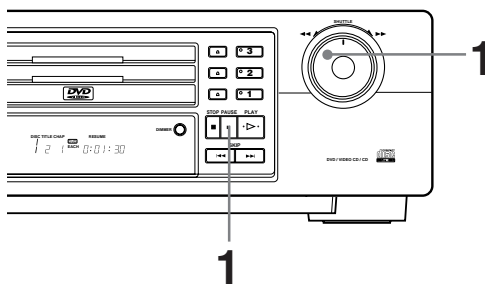

1 Press **II** (PAUSE), then use the SHUTTLE knob.

To play forward slow-motion, turn the SHUTTLE knob to the right. To play reverse slow-motion (for DVD discs only), turn it to the left. The more you turn the knob, the more the slow-motion speed increases.

• **To return to normal playback**

Press **▷**.

• **To pause slow-motion playback**

Press **II**.

NOTES

- The sound is muted during slow-motion playback.
- Reverse slow-motion playback is not possible for a Video CD.

To zoom a scene [ZOOM]

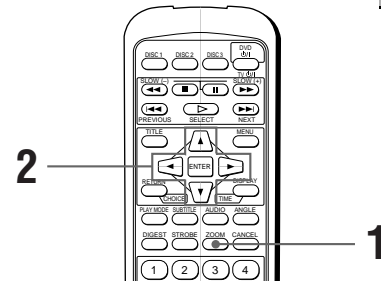

■ During playback or while paused

1 Press ZOOM.

"ZOOM" appears on the TV screen.

The unit zooms in to the center part of the scene to produce a double-sized image.

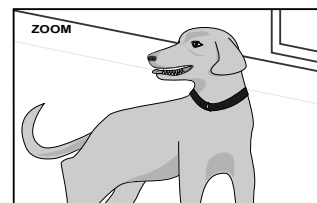
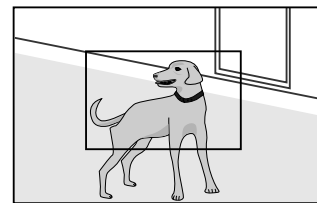

2 Use CURSOR **◀/▶/▲/▼** to move the zoomed-in scene.

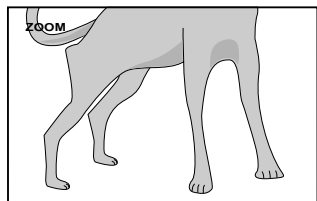

• **To pause zoom play**

Press **II**.

To resume zoom play, press **▷**.

• **To return to normal playback**

Press ZOOM.

NOTE

- During Zoom play, the picture may be garbled or noisy.

Changing the playback order

You can play titles and tracks on the discs inserted in the desired order or in random order.

To playback titles/tracks in the desired order [PROGRAM]



You can play titles or tracks on the discs inserted in the desired order by using the Program function.

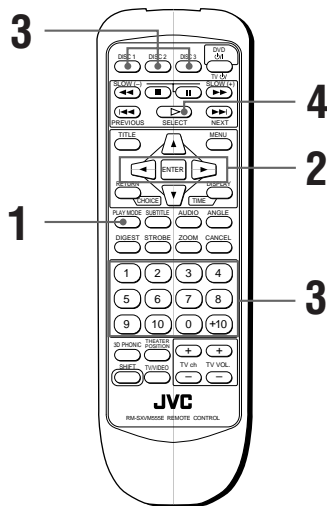

■ While stopped

1 Press PLAY MODE.

The play mode menu appears on the TV screen.

2 Use CURSOR \leftarrow/\rightarrow to move \leftarrow to [PROGRAM] and press ENTER.

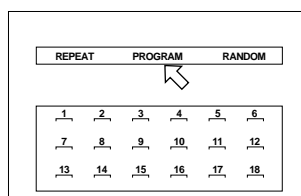

The program table appears under the menu bar (as shown above).

The "PROGRAM" indicator appears in the display window on the front panel.

3 Specify the disc by a DISC (1-3) button and then the title or track by the numeric buttons.

Up to 18 titles or tracks can be programmed by repeating this procedure.

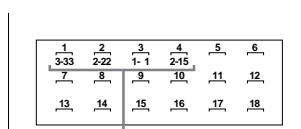

The programmed disc number and title/track number are shown under each program number.

• When you specify a wrong selection

Press CANCEL. The last selection programmed is erased.

• To clear the program

Press ■.

4 Press \triangleright to start program play.

When all of the programmed titles/tracks have finished playback, the unit stops but the program remains.

NOTES

- Some DVD discs may not be played back correctly in program mode.
- During program playback, you can use \lll and \ggg to skip to the previous/next selection of the program.
- By pressing PLAY MODE during program playback, the program table is displayed on the TV screen and the current program number is indicated in yellow.
- In program mode, the DISC buttons are invalid.

• To quit program playback

Press ■ twice.

The "PROGRAM" indicator in the display window turns off.

Note that the program remains.



While stopped and the play mode menu is displayed on the TV screen, by moving \leftarrow to [PROGRAM] and pressing ENTER, the program mode quits and the program is cleared.

To playback titles or tracks in random order [RANDOM]



You can play titles or tracks on the discs inserted in random order by using the Random function.

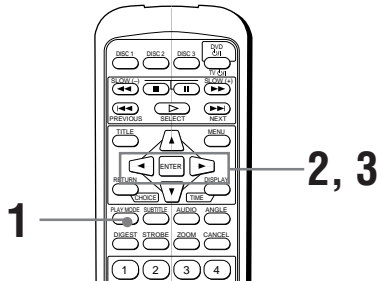

■ While stopped

1 Press PLAY MODE.

The play mode menu appears on the TV screen.

2 Use CURSOR ◀▶ to move to [RANDOM].

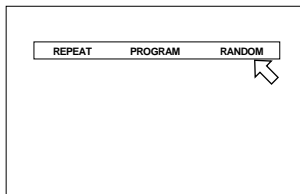

The “RANDOM” indicator appears in the display window on the front panel.

3 Press ENTER.

The unit starts random playback of the selected disc.

When all titles/tracks of the disc have been played once, the unit starts random playback of the next disc (if inserted). After playing all titles/tracks of the second disc, the unit starts random playback of the third disc (if inserted). After playing all titles/tracks of all the discs, random playback ends.



The same title or track will not be played back more than once during random play.

• To stop/quit random playback in the middle

Press ■ to stop playback. The unit is still in random playback mode, so pressing ▷ starts random playback again.

To quit random playback, press ■ again while stopped. The “RANDOM” indicator in the display window turns off.

NOTE

Some DVD discs may not be played back correctly in random mode.

Repeat playback

You can repeat playback of the current title or chapter (for DVD) or current track (for Audio CD/Video CD), or all discs inserted. You can also repeat playback of a desired part.

To repeat a current title, chapter or track, or all discs [REPEAT]

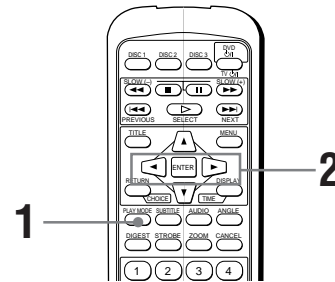

■ In any condition except Video CD playback with PBC

1 Press PLAY MODE.

The play mode menu appears on the TV screen.

2 Use CURSOR ◀▶ to move to [REPEAT], then press ENTER.

Each time you press ENTER, the repeat mode changes as follows:

• During DVD playback

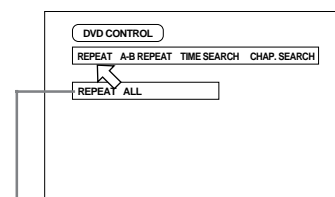

The selected repeat mode appears on the TV screen.

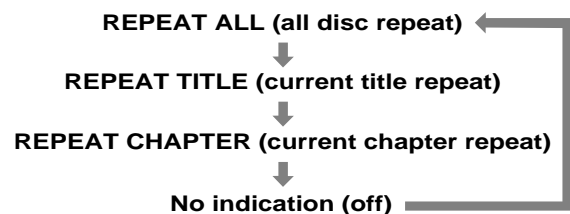

• During Audio/Video CD playback

(for Audio CD)

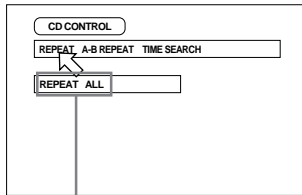

Selected repeat mode

(for Video CD)

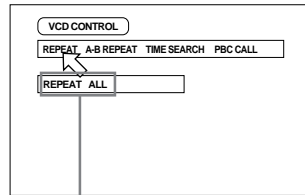

Selected repeat mode

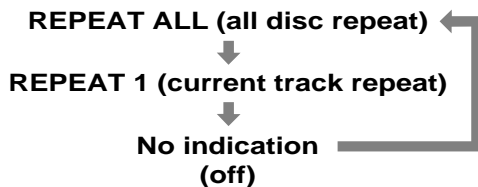

• While stopped

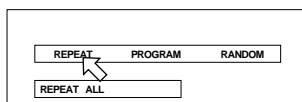

• To stop repeat playback

Press ■.

Hints

- If you press ■ in REPEAT ALL mode, the unit stops playback but remains in the mode.
- If you press ■ in REPEAT1, TITLE REPEAT or CHAPTER REPEAT mode, the unit stops playback and quits the mode.

• To quit repeat playback

With pointed at [REPEAT], press ENTER repeatedly until the mode is set to off.

NOTES

- Some DVD discs do not allow the title repeat or/and chapter repeat.
- Some DVD discs automatically stops playback in the middle of the disc.
If you execute REPEAT ALL with such a DVD disc inserted, when it automatically stops playback in the middle of the disc, the unit starts playback of the next disc.
- In the REPEAT ALL mode, if the next disc is a PBC-compatible Video CD disc, the unit plays the disc without PBC function.
- Repeat playback function cannot be used during Video CD playback with PBC function.
- To turn off the play mode menu display
Press PLAY MODE.

To repeat a desired part [A-B REPEAT]

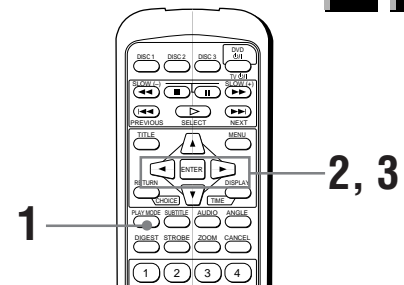

■ During playback

- 1 Press PLAY MODE.
The play mode menu appears on the TV screen.
- 2 Use CURSOR to move to [A-B REPEAT], then press ENTER at the beginning of the part you want to repeat (point A).
Make sure that REPEAT mode is off. If any one of the REPEAT modes is selected, you cannot move to [A-B REPEAT].
- 3 Press ENTER at the end of the part you want to repeat (point B).
The unit locates "A" and starts repeat playback between "A" and "B."

(for DVD)

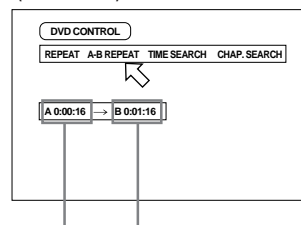

Point A Point B

(for Audio CD)

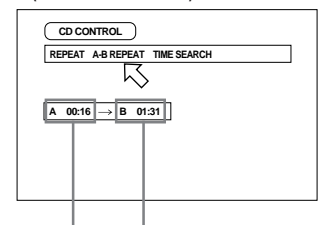

Point A Point B

(for Video CD)

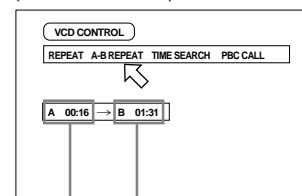

Point A Point B

To quit A-B repeat playback

Press ■. The unit stops playback and quits A-B repeat mode.



- During playback, pressing ENTER when is pointed at [A-B REPEAT] quits A-B repeat mode and continues playback.
- You can also quit A-B repeat mode by pressing I◀◀ or ▶▶I.

NOTES

- **To turn off the play mode menu**
Press PLAY MODE.
- If appears when pressing ENTER in step 2 during DVD playback
You cannot repeat the selected portion because of the disc contents.

Viewing from multiple angles

You can enjoy a variety of scene angles if the DVD disc contains "multi-angle" parts, where multiple cameras were used to shoot the same scene from different angles.



At the beginning of "multi-angle" parts, appears on the TV screen.

To select a scene angle from the normal screen [ANGLE]

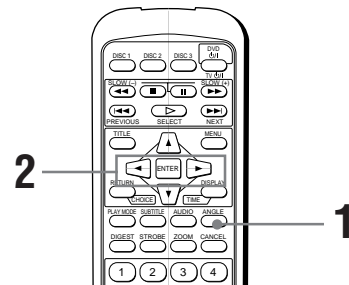

■ During DVD playback

1 Press ANGLE.

The Angle selection display appears on the TV screen.

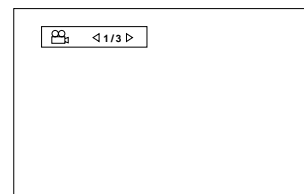

2 Press ANGLE or CURSOR ◀/▶ to select the desired angle.

Each time you press ANGLE or CURSOR ◀/▶, the angle changes.

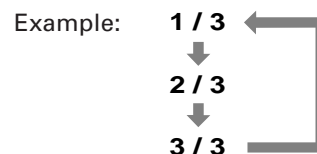

NOTES

- The Angle selection display will automatically disappear if you do not change the angle for 10 seconds.
- To turn off the Angle selection display manually, press ENTER.
- When appears on the TV screen
The current scene is not recorded from multiple angles.

To select a scene angle from the angle list display [ANGLE]

DVD

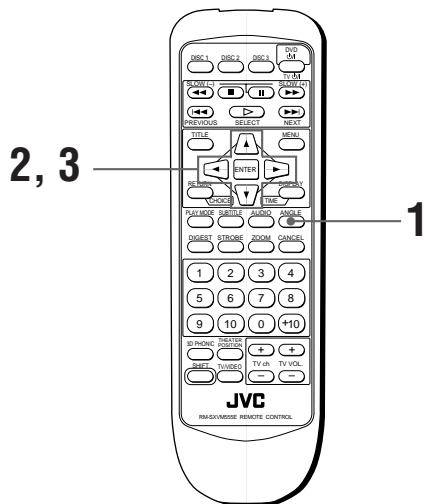

■ During DVD playback

1 Press and hold ANGLE for more than 1 second.

Up to nine camera angles recorded on a disc appear on the TV screen.

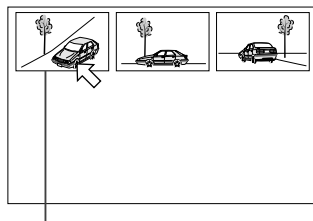

The selected camera angle

2 Use CURSOR ▲/▼/◀/▶ to select the desired angle.

3 Press ENTER.

■ The selected angle appears on the TV screen.

NOTES

- When  appears on the TV screen in step 1: The current scene is not recorded from multiple angles.
- During the operation above, audio is muted.

Changing the language and sound

For DVD discs, you can select the subtitle language, as well as the audio language/sound included on a disc. For Video CD discs, you can select the audio channel(s).

To select the subtitle language [SUBTITLE]

DVD

■ During DVD playback

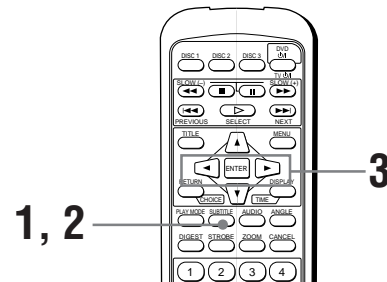

1 Press SUBTITLE.

The Subtitle selection display appears on the TV screen.

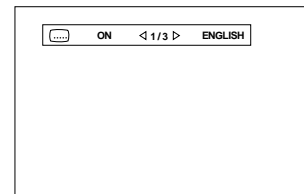

2 To turn the subtitle on and off, press SUBTITLE.

3 To select the desired subtitle language, press CURSOR ◀/▶.

Each time you press CURSOR ◀/▶, the subtitle language changes.

Example: **1/3 ENGLISH**

↓
2/3 FRENCH

↓
3/3 SPANISH

↓
-/3 (off)

NOTES

- For DVD, the selected languages may abbreviated on the TV screen. See "Appendix A: Table of languages and their abbreviations" at the end of this manual.
- The Subtitle selection display will automatically disappear if you do not change the subtitle for 10 seconds.
- To turn off the Subtitle selection display manually, press ENTER.
- When  appears on the TV screen: You cannot select the subtitle.

To change the audio language or sound [AUDIO]



By AUDIO selection, you can choose the audio language of movies or choose to enjoy karaoke with or without the guide vocal.

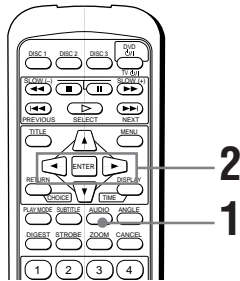

■ During playback

1 Press AUDIO.

The Audio selection display appears on the TV screen.

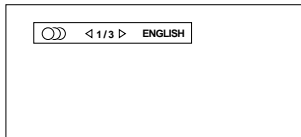

2 Press AUDIO or CURSOR ◀▶ to select the desired audio.

• For DVD

Each time you press AUDIO or CURSOR ◀▶, the audio language or sound changes.

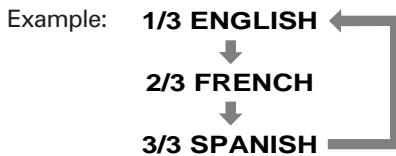

• For Video CD

Each time you press AUDIO or CURSOR ◀▶, the playback audio changes as follows.

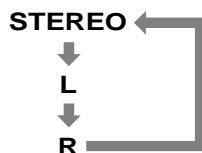

NOTES

- For DVD, the selected languages may abbreviated on the TV screen. See "Appendix A: Table of languages and their abbreviations" at the end of this manual.
- The Audio selection display will automatically disappear if you do not change the audio for 10 seconds.
- To turn off the Audio selection display manually, press ENTER.
- When appears on the TV screen: You cannot select the audio.

Selecting the picture character

You can select the quality of the image from among four options (OFF, 1, 2 and 3) according to the type of programming, picture tone or personal preferences.

To select the picture character [THEATER POSITION]

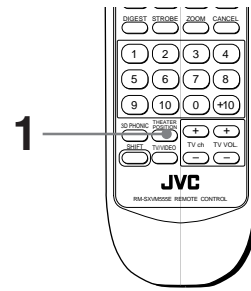

■ During playback

1 Press THEATER POSITION to select the desired picture character.

Each time you press the button, the picture character changes as follows:



Selected effect mode

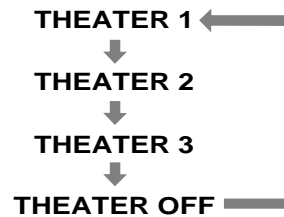

"THEATER OFF" is the normal position. Selecting a higher number tones down the picture character.

Enjoying virtual surround sound

Using the 3D Phonic function, you can get a simulated surround effect from your stereo system.

To simulate surround sound [3D PHONIC]

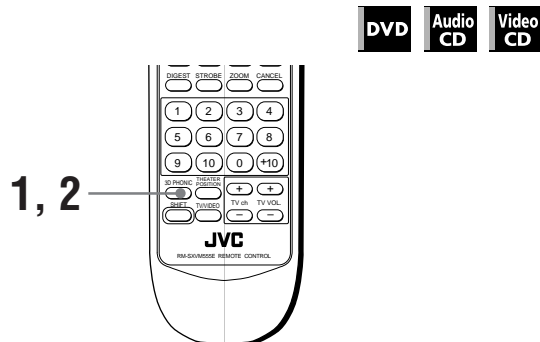

■ During playback

1 Press 3D PHONIC.

2 Select the desired effect mode by pressing 3D PHONIC.

Each time you press 3D PHONIC, the effect mode changes as follows:

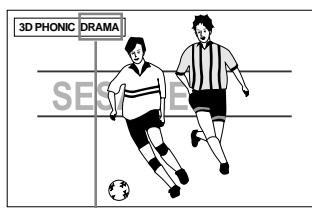

Selected effect mode



- **ACTION:**
Suitable for action movies and sports programs in which sounds dynamically move.
- **DRAMA:**
Natural and warm sound. You can enjoy movies in a relaxed mood.
- **THEATER:**
You can enjoy sound effects like in a major theater in Hollywood.

* When you play a DVD disc recorded in Dolby Digital which contains more than 3 channels, ACTION does not appear.

NOTES

- The 3D phonic function works correctly when playing back discs recorded in the Dolby Surround or Dolby Digital 5.1-CH format.
It also works when playing back discs other than those above, but does not provide the correct effect.
- The 3D Phonic function does not affect the DTS or Dolby Digital bitstream signal from the DIGITAL OUT jack.
- The sound effect will not be set or operate, even if 3D PHONIC is pressed, for the sound of DVD discs recorded in Linear PCM.
- When you set the 3D PHONIC function to on, the DOWN MIX and COMPRESSION settings in the AUDIO page of the preference display are disabled.

Checking the status

You can check the disc/time information, as well as the DVD functions, of the current disc.

To check the disc/time information

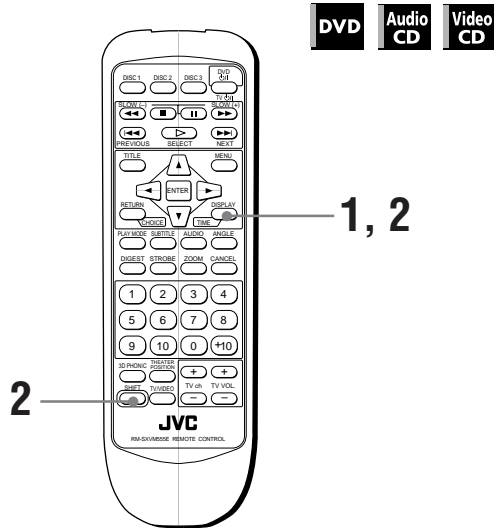

■ During playback

- 1 Press DISPLAY-TIME once for an Audio CD or Video CD disc, or twice for a DVD disc.

The disc/time display appears on the TV screen.

(for DVD)

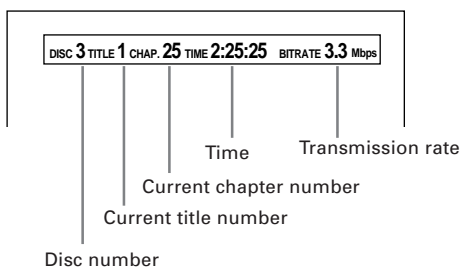

(for Audio CD, or Video CD playing without PBC)

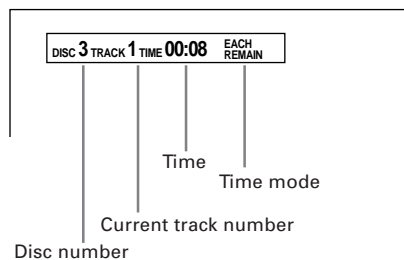

(for Video CD playing with PBC)

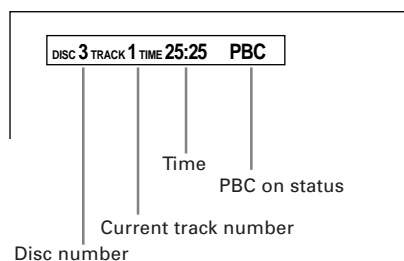

- 2 To change the time display mode (only for Audio CD or Video CD without PBC), press DISPLAY-TIME while holding down SHIFT.

The time display mode cycles as below.

(for Audio CD)

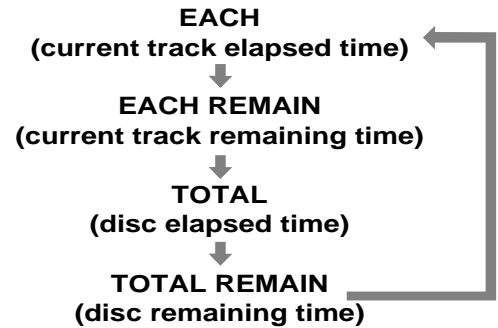

(for Video CD without PBC)



The selected time information is displayed on the TV screen, as well as in the front panel display window.

■ While stopped

You can check the total disc time and current (selected) track time of an Audio CD/Video CD only from the front panel display window.

- 1 Press DISPLAY - TIME while holding down SHIFT.

When EACH and REMAIN are indicated, the current (selected) track time appears. When only REMAIN is indicated, the total disc time appears.



You can change the current (selected) track by pressing ◀◀ or ▶▶.

- **To turn off the disc/time display**
Press DISPLAY-TIME.

To check the DVD function status



- During DVD playback

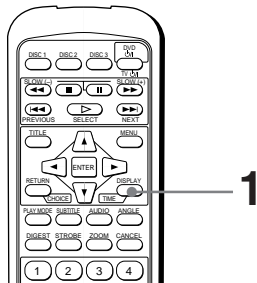

1 Press DISPLAY – TIME.

The DVD function status display appears on the TV screen.

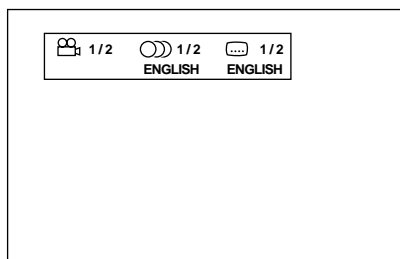

The current selections of the camera angle, audio language and subtitle language are displayed.

- **To turn off the DVD function status display**

Press DISPLAY-TIME twice.

Selecting preferences

You can set various preferences for playback via four dedicated displays.

How to set preferences

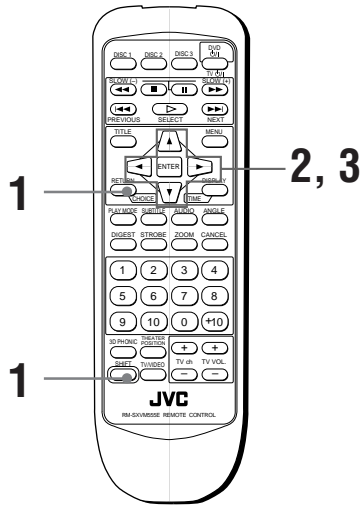

1 When a DVD or Video CD disc is stopped or no disc is inserted, press RETURN-CHOICE while holding down SHIFT.

One of the preference pages appears on the TV screen.

There are four preference pages: LANGUAGE, AUDIO, DISPLAY and SYSTEM. To turn the page, move to the desired tab using CURSOR .

LANGUAGE

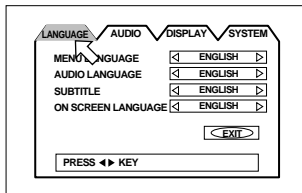

AUDIO

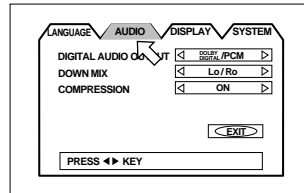

DISPLAY

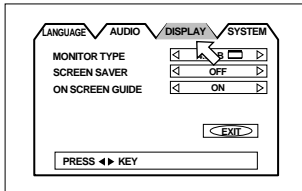

SYSTEM

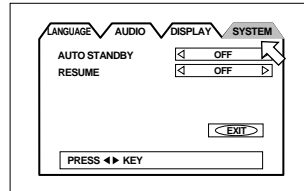

2 Move to select the item you want to set by using CURSOR .

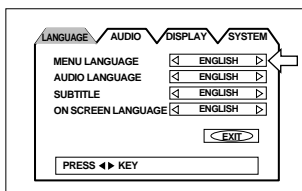

3 Press CURSOR to select the setting you want.

- To cancel display of the preference display, press RETURN-CHOICE while holding down SHIFT, or move to [EXIT] and press ENTER.
- For details about each setting, see the paragraphs below:

LANGUAGE page

MENU LANGUAGE

You can select a default “display” language to be displayed if it is contained on the disc.

Each time you press CURSOR , the language setting changes in the following order:

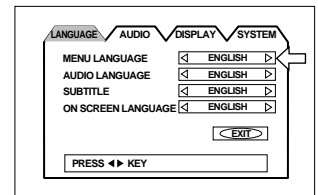

ENGLISH → SPANISH → FRENCH → CHINESE → GERMAN → ITALIAN → JAPANESE → language code from AA to ZU

(See “Table of languages and their abbreviations” at the end of this manual.)

Pressing CURSOR changes the language setting in the reverse order of the above.

* If the selected language is not recorded, the disc’s default display language is displayed.

AUDIO LANGUAGE

You can select the default audio language to be played if it is contained on the disc.

Each time you press CURSOR , the language setting changes in the following order:

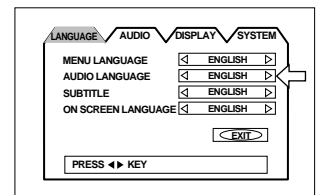

ENGLISH → SPANISH → FRENCH → CHINESE → GERMAN → ITALIAN → JAPANESE → language code from AA to ZU

(See “Table of languages and their abbreviations” at the end of this manual.)

Pressing CURSOR changes the language setting in the reverse order of the above.

* If the selected language is not recorded, the disc’s default audio language will be played.

SUBTITLE

You can select the default subtitle language to be displayed when it is contained on a playback disc.

Each time you press CURSOR ►, the language setting changes in the following order:

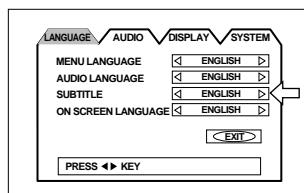

ENGLISH → SPANISH → FRENCH → CHINESE → GERMAN → ITALIAN → JAPANESE → language code from AA to ZU

(See "Table of languages and their abbreviations" at the end of this manual.)

Pressing CURSOR ◀ changes the language setting in the reverse order of the above.

* If the selected language is not recorded, the disc's default subtitle language will be displayed.

ON SCREEN LANGUAGE

You can select the on-screen display language to be displayed.

Each time you press CURSOR ◀/►, the language setting changes as follows:

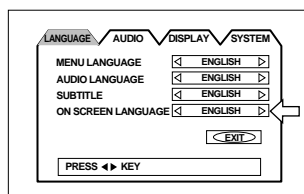

| | |
|---------|------------------------------------|
| English | ON SCREEN LANGUAGE ◀ ENGLISH ▶ |
| German | BILDSCHIRMENUE-SPRACHE ◀ DEUTSCH ▶ |
| French | LANGUE D'ECRAN ◀ FRANCAIS ▶ |

AUDIO page

DIGITAL AUDIO OUTPUT

To connect the unit's digital output to an external device equipped with a digital input, this item must be set correctly.

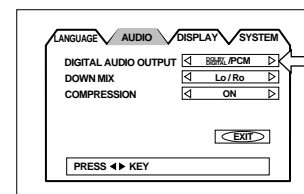

- **PCM ONLY:**
When you connect the DIGITAL OUT jack of the unit to the linear PCM digital input of other audio equipment.
- **STREAM/PCM:**
When you connect to the digital input of an amplifier with a built-in DTS, Dolby Digital, or MPEG multichannel decoder.
- **DOLBY DIGITAL/PCM:**
When you connect to the digital input of a Dolby Digital decoder, or an amplifier with a built-in Dolby Digital decoder

The following chart shows the relationship between types of playback discs and output signals.

| Playback discs | Output | | |
|---------------------------------------|-----------------------------|---------------------------|---------------------------|
| | STREAM/PCM | DOLBY DIGITAL/PCM | PCM ONLY |
| DVD with 48-kHz, 16-bit linear PCM | 48-kHz, 16-bit linear PCM | ← | ← |
| DVD with 48-kHz, 20/24-bit linear PCM | 48-kHz, 20-bit linear PCM | ← | ← |
| DVD with 96-kHz, linear PCM | No output | ← | ← |
| DVD with DTS | DTS bitstream | No output | ← |
| DVD with Dolby Digital | Dolby Digital bitstream | ← | 48-kHz, 16-bit linear PCM |
| DVD with MPEG multichannel | MPEG bitstream | 48-kHz, 16-bit linear PCM | ← |
| Video CD | 44.1-kHz, 16-bit linear PCM | ← | ← |
| Audio CD | 44.1-kHz, 16-bit linear PCM | ← | ← |
| Audio CD with DTS | DTS bitstream | ← | ← |

NOTES

- The unit does not provide the DTS decoding function.
- When playing a DVD or Audio CD disc with DTS, use a DTS decoder to get the correct signals for your speakers. Never use the unit's analog output jacks, which output incorrect signals that may damage your speakers.

If you connect the analog outputs and digital outputs simultaneously, be sure to select the source of the amplifier correctly, or set the level control of the amplifier connected to the analog outputs to minimum.

DOWN MIX

By setting DOWN MIX correctly, you can get the optimum stereo mix for your audio system from DVD discs recorded with Dolby Digital surround multichannel audio.

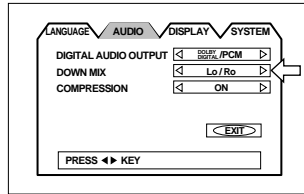

- **Lt/Rt (Dolby Digital disc only):**
For monitoring the unit's 2-channel audio output signals via a Dolby Pro Logic decoder.
- **Lo/Ro:**
For monitoring the unit's 2-channel audio output signals via a TV or an amplifier without built-in Dolby Pro Logic decoder. This is also for recording DVD audio to a cassette tape, MD, etc.

NOTE

- The Down mix function does not work when the 3D PHONIC function is activated.

COMPRESSION

You can compress the dynamic range of the sound if needed. Using this function, you can listen to sound at low volumes easily.

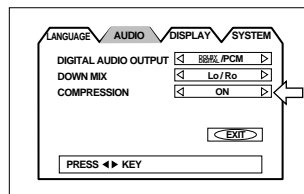

- **ON**
Audio is played back with the dynamic range compressed.
- **OFF**
Audio is played back as it was recorded.

NOTES

- The Compression function works only when playing back a disc recorded with DOLBY DIGITAL 1CH or 2CH. The setting is not effective for other discs.
- The Compression function does not work when the 3D PHONIC function is activated.

DISPLAY page

MONITOR TYPE

You can select the monitor type to match your TV when you playback DVD discs recorded for wide screen televisions.

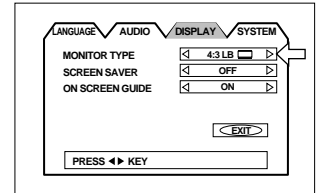

- **4:3 LB** (Letter Box Conversion)
When you connect a normal TV to the unit.
When you play a wide picture recorded on a DVD disc, the picture is displayed with bands across the upper and lower portions of the screen.



- **4:3 PS** (Pan scan Conversion)
When you connect a normal TV to the unit.
When you play a wide picture recorded on a DVD disc, a portion of the picture is automatically cut off from the left and right sides of the image.
Depending on the disc, it may not be possible to playback in this mode. In that case, the picture is played back as in 4:3 LB mode.

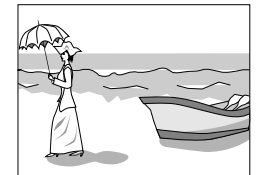

- **16:9 WIDE** (Wide Television screen)
When you connect a wide-screen TV to the unit.

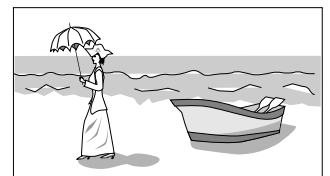

SCREEN SAVER

A television monitor screen may be burned out if a static picture is displayed for a long time. To prevent this, the unit automatically activates the screen saver function if a static picture, such as an on-screen display or menu, is displayed for over 5 minutes.

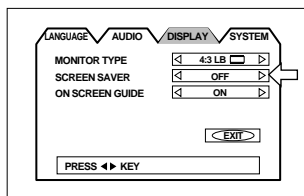

- **MODE 1**
The current picture gets dark.
- **MODE 2**
The "screen saver" picture appears and its brightness changes.
- **OFF**
The screen saver function is off.

NOTES

- The monitor screen of a projector or projection TV is easily burned out if the screen saver mode is set to OFF and a static picture is displayed for a long time.
- The screen saver function is not activated when the selected disc is an Audio CD.

ON SCREEN GUIDE

The unit can display "on-screen guide" icons or characters on the picture, which show what is happening to the disc or the unit.

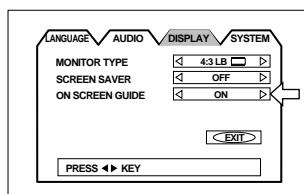

- **ON**
The guide display is turned on.
- **OFF**
The guide display is turned off.

Examples of "on-screen guide" icons or characters:



SYSTEM page

AUTO STANDBY

When the unit is stopped for more than 30 minutes or 60 minutes, the unit enters standby mode automatically.

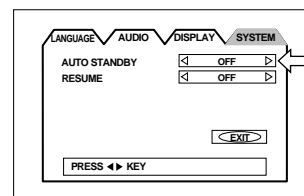

- **60**
Time is set to 60 minutes.
- **30**
Time is set to 30 minutes.
- **OFF**
The auto standby function is off.

RESUME

You can select the resume function to be on or off. See page 19.

- **ON**
Pressing > while stopped starts playback from the resume point if it is memorized.
- **OFF**
Pressing > while stopped starts playback from the beginning of the disc.

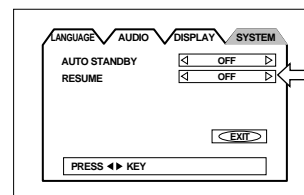

Limiting playback by children

This function restricts playback of DVD discs which contain violent (and other) scenes according to the level set by the user. For example, if a movie which includes violent scenes supports the parental lock feature, such scenes which you do not want to let children view can be cut or replaced with other scenes.

To set Parental Lock for the first time [PARENTAL LOCK]

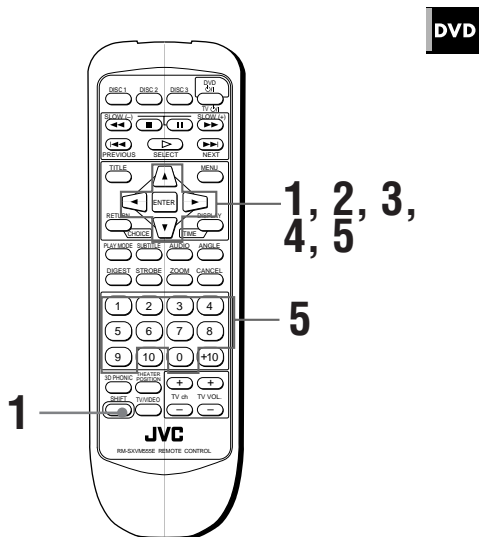

Each time you press CURSOR ◀/▶, the parental level changes between 1 and 8.



“1” is the strictest level. “8” means no restriction. Discs rated higher than the selected level are restricted.

- 4 Press ENTER.
- 5 Enter your 4-digit password using the numeric buttons (0 to 9) and press ENTER.

The parental level and password are set.

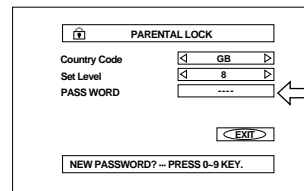

■ While a DVD disc is stopped or no disc is inserted in the selected disc tray

- 1 Press ENTER while holding down SHIFT.

The Parental Lock on-screen display appears on the TV screen.

- 2 Use CURSOR ▲/▼ to move to [Country Code], then use CURSOR ◀/▶ to select the country code and press ENTER.

The country code whose standards were applied to rate the DVD video disc should be selected. See “Appendix B: Country code list for parental lock”.

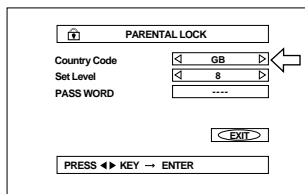

- 3 Use CURSOR ▲/▼ to move to [Set Level], then use CURSOR ◀/▶ to select the parental lock level.

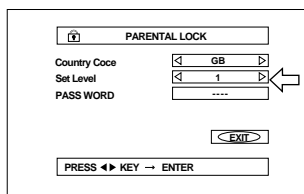

To change the settings [PARENTAL LOCK]

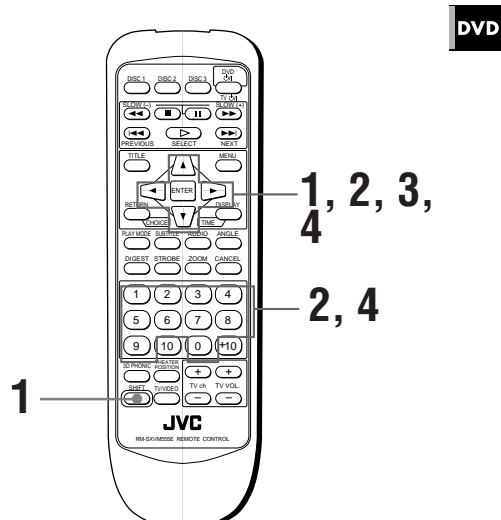

DVD

- While a DVD disc is stopped or no disc is inserted

1 Press ENTER while holding down SHIFT.

The Parental Lock on-screen display appears on the TV screen.

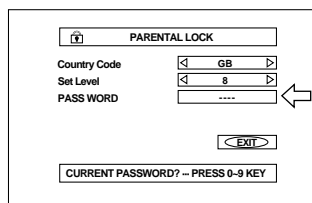

2 Enter your current 4-digit password using the numeric buttons (0 to 9) and press ENTER.

If you enter the wrong password, "WRONG! RETRY....." appears on the TV screen, and you cannot go to next step.

3 Use CURSOR ▲/▼ to move to [Set Level], and use CURSOR ◀/▶ to select the parental lock level, then press ENTER.

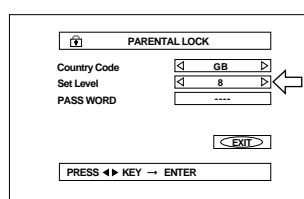

4 Enter your new 4-digit password using the numeric buttons (0 to 9) and press ENTER.

The new setting is effective.

NOTES

- When you enter the wrong password more than 3 times in step 2 above, the cursor moves to [EXIT] automatically and CURSOR ▲/▼ does not work.
- If you forget your password in step 2 Enter "8888."

To temporarily release the Parental lock [PARENTAL LOCK]

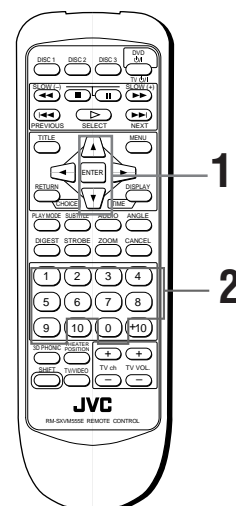

DVD

When you set the parental level strictly, some discs may not be played back at all. When you insert such a disc and try to play it, the Parental Lock on-screen display appears on the TV screen, and the unit will ask you whether you want the parental lock to be temporarily released or not.

1 Use the CURSOR ▲/▼ to move to [YES] or [NO], then press ENTER.

If you select [YES] and press ENTER, the cursor moves to the PASSWORD field.

When selecting [NO], press the corresponding ▲ to remove the disc.

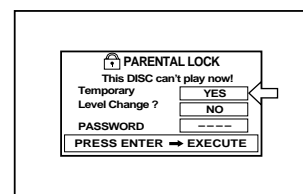

2 Enter your 4-digit password using the numeric buttons (0 to 9).

If you enter the wrong password, "WRONG! RETRY..." appears on the TV screen, and you cannot go to next step.

The Parental lock is released, and the unit starts playback.

NOTE

- When you enter the wrong password more than 3 times in step 2 above, the cursor moves to [NO] automatically and CURSOR ▲/▼ do not work.

Care and handling of discs

How to handle discs

When handling a disc, do not touch the surface of the disc.

Since discs are made of plastic, they are easily damaged. If a disc gets dirty, dusty, scratched or warped, the images and sound will not be picked up correctly, and such a disc may cause the player to malfunction.

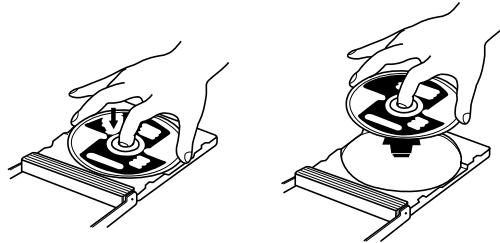

Label side

Do not damage the label side, stick paper to or use any adhesive on its surface.

Storage

Make sure that discs are kept in their cases. If discs are piled on top of one another without their protective cases, they can be damaged. Do not put discs in a location where they may be exposed to direct sunlight, or in a place where the humidity or temperature is high. Avoid leaving discs in your car!

Maintenance of discs

If there are fingerprints or other dirt adhering to a disc, wipe with a soft dry cloth, moving from the center outwards. If a disc is difficult to clean, wipe with a cloth moistened with water. Never use record cleaners, petrol, alcohol or any anti-static agents.

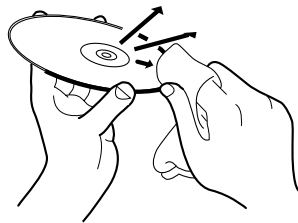

CAUTION

Sometimes during play noise or images may be garbled. This is sometimes due to the disc. (It may not be up to industry standards.)

These symptoms are caused by the discs, not by the malfunction of the unit.

Troubleshooting

What appears to be a malfunction may not always be serious. Please go through the following list before requesting service.

| Symptom | Possible case | Remedy |
|---|--|---|
| Power does not come on. | Power plug is not inserted securely. | Plug in securely. |
| Remote control does not work. | Too far from the unit. | Move closer to the unit. |
| | The tip of the remote unit is not pointed in the right direction. | Point the infrared light-emitting window toward the remote sensor on the front panel. |
| | Batteries are exhausted. | Replace the batteries with new ones. |
| | Battery polarity is incorrect. | Take out the batteries and insert them again in the correct direction. |
| No picture is displayed on the monitor. | Connection of video cable is incorrect. | Connect the cable correctly. |
| | Input selection of TV is incorrect. | Select correctly. |
| | Disc is not playable. | Use a playable disc. (See page 11.) |
| Picture is noisy. | The unit is connected to a VCR directly and the copyguard function is activated. | Connect the unit so that the picture signal flows directly to the TV. |
| No audio is reproduced. | Connection is incorrect. | Check the connections. |
| | Input selection of amplifier is incorrect. | Select correctly. |
| No audio is reproduced when playing back a DVD disc recorded with 96-kHz, linear PCM audio. | The audio signal is derived from the unit's DIGITAL OUT. | Use the AUDIO OUT when playing back such discs. |
| Sound is distorted or noise is generated. | Disc is dirty. | Wipe the disc surface. |
| Picture does not fit the television screen. | MONITOR TYPE is not correctly set. | Select monitor type correctly. (See page 37.) |
| | Television is not correctly set. | Set the television correctly. |
| Operation is not possible. | Microcomputer malfunction due to lightning or static electricity. | Turn off the power and unplug the power cord, then connect the power cord again. |
| | Moisture condensation caused by a sudden change of temperature or humidity. | Turn off the power, then turn it on a few hours later. |

Specifications

General

Readable discs: DVD VIDEO, Audio CD, Video CD
 Video format: PAL

Other

Power requirements: AC 230 V ~, 50 Hz
 Power consumption: 20 W (POWER ON), 3.8 W (STANDBY mode)
 Mass: 5.1 kg (11.3 lbs)
 Dimensions (W x H x D): 435 x 126.5 x 324.6 mm
 17-3/16 x 5 x 12-13/16 inch

Video output

VIDEO OUT (pin jack): 1.0 Vp-p (75 ohms)
 S-VIDEO OUT (S jack): Y Output: 1.0 Vp-p (75 ohms)
 C Output: 286 mVp-p (75 ohms)
 Horizontal resolution: 500 Lines
 Signal to noise ratio: 65 dB

Audio output

ANALOG OUT (pin jack): 2.0 Vrms (10 k ohms)
 DIGITAL OUT (optical): - 21 to -15 dBm (Peak)

Audio characteristics

Frequency response: CD (sampling frequency 44.1 kHz): 2 Hz to 20 kHz
 DVD (sampling frequency 48 kHz): 2 Hz to 22 kHz
 DVD (sampling frequency 96 kHz): 2 Hz to 44 kHz
 Dynamic range: 16 bit: More than 98 dB
 20 bit: More than 106 dB
 24 bit: More than 106 dB
 Wow and flutter: Unmeasurable (less than ± 0.002%)
 Total harmonic distortion: Less than 0.002%

* Specifications and appearance subject to change without prior notice.

Appendix A: Table of languages and their abbreviations

When you select the subtitle language or sound, the languages shown below are displayed as abbreviations. To select the desired language, select the abbreviation corresponding the language you want to.

| | | | | | | | | | |
|----|-----------------|----|--------------|----|------------------|----|----------------|----|------------|
| AA | Afar | FA | Persian | KM | Cambodian | OM | (Afan) Oromo | SU | Sundanese |
| AB | Abkhazian | FI | Finnish | KN | Kannada | OR | Oriya | SV | Swedish |
| AF | Afrikaans | FJ | Fiji | KO | Korean (KOR) | PA | Panjabi | SW | Swahili |
| AM | Ameharic | FO | Faroese | KS | Kashmiri | PL | Polish | TA | Tamil |
| AR | Arabic | FY | Frisian | KU | Kurdish | PS | Pashto, Pushto | TE | Telugu |
| AS | Assamese | GA | Irish | KY | Kirghiz | PT | Portuguese | TG | Tajik |
| AY | Aymara | GD | Scots Gaelic | LA | Latin | QU | Quechua | TH | Thai |
| AZ | Azerbaijani | GL | Galician | LN | Lingala | RM | Rhaeto-Romance | TI | Tigrinya |
| BA | Bashkir | GN | Guarani | LO | Laothian | RN | Kirundi | TK | Turkmen |
| BE | Byelorussian | GU | Gujarati | LT | Lithuanian | RO | Rumanian | TL | Tagalog |
| BG | Bulgarian | HA | Hausa | LV | Latvian, Lettish | RU | Russian | TN | Setswana |
| BH | Bihari | HI | Hindi | MG | Malagasy | RW | Kinyarwanda | TO | Tonga |
| BI | Bislama | HR | Croatian | MI | Maori | SA | Sanskrit | TR | Turkish |
| BN | Bengali, Bangla | HU | Hungarian | MK | Macedonian | SD | Sindhi | TS | Tsonga |
| BO | Tibetan | HY | Armenian | ML | Malayalam | SG | Sangho | TT | Tatar |
| BR | Breton | IA | Interlingua | MN | Mongolian | SH | Serbo-Croatian | TW | Twì |
| CA | Catalan | IE | Interlingue | MO | Moldavian | SI | Singhalese | UK | Ukrainian |
| CO | Corsican | IK | Inupiak | MR | Marathi | SK | Slovak | UR | Urdu |
| CS | Czech | IN | Indonesian | MS | Malay (MAY) | SL | Slovenian | UZ | Uzbek |
| CY | Welsh | IS | Icelandic | MT | Maltese | SM | Samoan | VI | Vietnamese |
| DA | Danish | IW | Hebrew | MY | Burmese | SN | Shona | VO | Volapuk |
| DZ | Bhutani | JI | Yiddish | NA | Nauru | SO | Somali | WO | Wolof |
| EL | Greek | JW | Javanese | NE | Nepali | SQ | Albanian | XH | Xhosa |
| EO | Esperanto | KA | Georgian | NL | Dutch | SR | Serbian | YO | Yoruba |
| ET | Estonian | KK | Kazakh | NO | Norwegian | SS | Siswati | ZU | Zulu |
| EU | Basque | KL | Greenlandic | OC | Occitan | ST | Sesotho | | |

Additional information

Appendix B: Country code list for parental lock

This list is used for the Parental Lock operation. For details, see page 39.

| | |
|----|--------------------------|
| AD | Andorra |
| AE | United Arab Emirates |
| AF | Afghanistan |
| AG | Antigua and Barbuda |
| AI | Anguilla |
| AL | Albania |
| AM | Armenia |
| AN | Netherlands Antilles |
| AO | Angola |
| AQ | Antarctica |
| AR | Argentina |
| AS | American Samoa |
| AT | Austria |
| AU | Australia |
| AW | Aruba |
| AZ | Azerbaijan |
| BA | Bosnia and Herzegovina |
| BB | Barbados |
| BD | Bangladesh |
| BE | Belgium |
| BF | Burkina Faso |
| BG | Bulgaria |
| BH | Bahrain |
| BI | Burundi |
| BJ | Benin |
| BM | Bermuda |
| BN | Brunei Darussalam |
| BO | Bolivia |
| BR | Brazil |
| BS | Bahamas |
| BT | Bhutan |
| BV | Bouvet Island |
| BW | Botswana |
| BY | Belarus |
| BZ | Belize |
| CA | Canada |
| CC | Cocos (Keeling) Islands |
| CF | Central African Republic |
| CG | Congo |
| CH | Switzerland |
| CI | Côte d'Ivoire |
| CK | Cook Islands |
| CL | Chile |
| CM | Cameroon |
| CN | China |
| CO | Colombia |
| CR | Costa Rica |
| CU | Cuba |
| CV | Cape Verde |
| CX | Christmas Island |
| CY | Cyprus |
| CZ | Czech Republic |
| DE | Germany |
| DJ | Djibouti |
| DK | Denmark |
| DM | Dominica |
| DO | Dominican Republic |
| DZ | Algeria |
| EC | Ecuador |
| EE | Estonia |
| EG | Egypt |
| EH | Western Sahara |
| ER | Eritrea |

| | |
|----|--|
| ES | Spain |
| ET | Ethiopia |
| FI | Finland |
| FJ | Fiji |
| FK | Falkland Islands (Malvinas) |
| FM | Micronesia (Federated States of) |
| FO | Faroe Islands |
| FR | France |
| FX | France, Metropolitan |
| GA | Gabon |
| GB | United Kingdom |
| GD | Grenada |
| GE | Georgia |
| GF | French Guiana |
| GH | Ghana |
| GI | Gibraltar |
| GL | Greenland |
| GM | Gambia |
| GN | Guinea |
| GP | Guadeloupe |
| GQ | Equatorial Guinea |
| GR | Greece |
| GS | South Georgia and the South Sandwich Islands |
| GT | Guatemala |
| GU | Guam |
| GW | Guinea-Bissau |
| GY | Guyana |
| HK | Hong Kong |
| HM | Heard Island and McDonald Islands |
| HN | Honduras |
| HR | Croatia |
| HT | Haiti |
| HU | Hungary |
| ID | Indonesia |
| IE | Ireland |
| IL | Israel |
| IN | India |
| IO | British Indian Ocean Territory |
| IQ | Iraq |
| IR | Iran (Islamic Republic of) |
| IS | Iceland |
| IT | Italy |
| JM | Jamaica |
| JO | Jordan |
| JP | Japan |
| KE | Kenya |
| KG | Kyrgyzstan |
| KH | Cambodia |
| KI | Kiribati |
| KM | Comoros |
| KN | Saint Kitts and Nevis |
| KP | Korea, Democratic People's Republic of |
| KR | Korea, Republic of |
| KW | Kuwait |
| KY | Cayman Islands |
| KZ | Kazakhstan |
| LA | Lao People's Democratic Republic |

| | |
|----|---------------------------|
| LB | Lebanon |
| LC | Saint Lucia |
| LI | Liechtenstein |
| LK | Sri Lanka |
| LR | Liberia |
| LS | Lesotho |
| LT | Lithuania |
| LU | Luxembourg |
| LV | Latvia |
| LY | Libyan Arab Jamahiriya |
| MA | Morocco |
| MC | Monaco |
| MD | Moldova, Republic of |
| MG | Madagascar |
| MH | Marshall Islands |
| ML | Mali |
| MM | Myanmar |
| MN | Mongolia |
| MO | Macau |
| MP | Northern Mariana Islands |
| MQ | Martinique |
| MR | Mauritania |
| MS | Montserrat |
| MT | Malta |
| MU | Mauritius |
| MV | Maldives |
| MW | Malawi |
| MX | Mexico |
| MY | Malaysia |
| MZ | Mozambique |
| NA | Namibia |
| NC | New Caledonia |
| NE | Niger |
| NF | Norfolk Island |
| NG | Nigeria |
| NI | Nicaragua |
| NL | Netherlands |
| NO | Norway |
| NP | Nepal |
| NR | Nauru |
| NU | Niue |
| NZ | New Zealand |
| OM | Oman |
| PA | Panama |
| PE | Peru |
| PF | French Polynesia |
| PG | Papua New Guinea |
| PH | Philippines |
| PK | Pakistan |
| PL | Poland |
| PM | Saint Pierre and Miquelon |
| PN | Pitcairn |
| PR | Puerto Rico |
| PT | Portugal |
| PW | Palau |
| PY | Paraguay |
| QA | Qatar |
| RE | Réunion |
| RO | Romania |
| RU | Russian Federation |
| RW | Rwanda |

| | |
|----|--------------------------------------|
| SA | Saudi Arabia |
| SB | Solomon Islands |
| SC | Seychelles |
| SD | Sudan |
| SE | Sweden |
| SG | Singapore |
| SH | Saint Helena |
| SI | Slovenia |
| SJ | Svalbard and Jan Mayen |
| SK | Slovakia |
| SL | Sierra Leone |
| SM | San Marino |
| SN | Senegal |
| SO | Somalia |
| SR | Suriname |
| ST | Sao Tome and Principe |
| SV | El Salvador |
| SY | Syrian Arab Republic |
| SZ | Swaziland |
| TC | Turks and Caicos Islands |
| TD | Chad |
| TF | French Southern Territories |
| TG | Togo |
| TH | Thailand |
| TJ | Tajikistan |
| TK | Tokelau |
| TM | Turkmenistan |
| TN | Tunisia |
| TO | Tonga |
| TP | East Timor |
| TR | Turkey |
| TT | Trinidad and Tobago |
| TV | Tuvalu |
| TW | Taiwan, Province of China |
| TZ | Tanzania, United Republic of |
| UA | Ukraine |
| UG | Uganda |
| UM | United States Minor Outlying Islands |
| US | United States |
| UY | Uruguay |
| UZ | Uzbekistan |
| VA | Vatican City State (Holy See) |
| VC | Saint Vincent and the Grenadines |
| VE | Venezuela |
| VG | Virgin Islands (British) |
| VI | Virgin Islands (U.S.) |
| VN | Vietnam |
| VU | Vanuatu |
| WF | Wallis and Futuna Islands |
| WS | Samoa |
| YE | Yemen |
| YT | Mayotte |
| YU | Yugoslavia |
| ZA | South Africa |
| ZM | Zambia |
| ZR | Zaire |
| ZW | Zimbabwe |

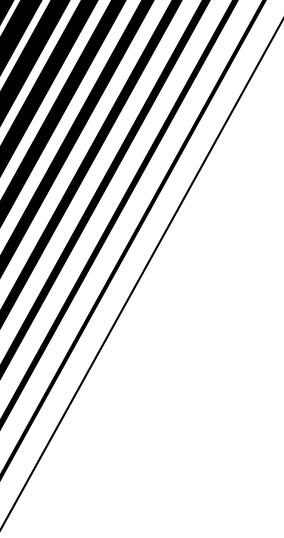

JVC

VICTOR COMPANY OF JAPAN, LIMITED