

JVC

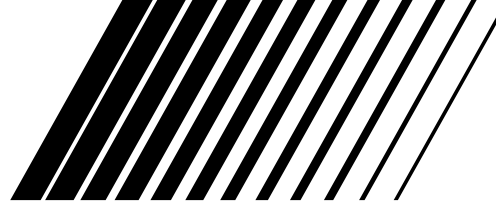

MICRO COMPONENT SYSTEM
MIKRO-KOMPONENTEN-SYSTEM
SYSTEME DE MICROCOMPOSANTS
MIKRO KOMPONENTEN-SYSTEEM
SISTEMAS DE MICROCOMPONENTES
SISTEMA A MICROCOMPONENTI

UX-V3

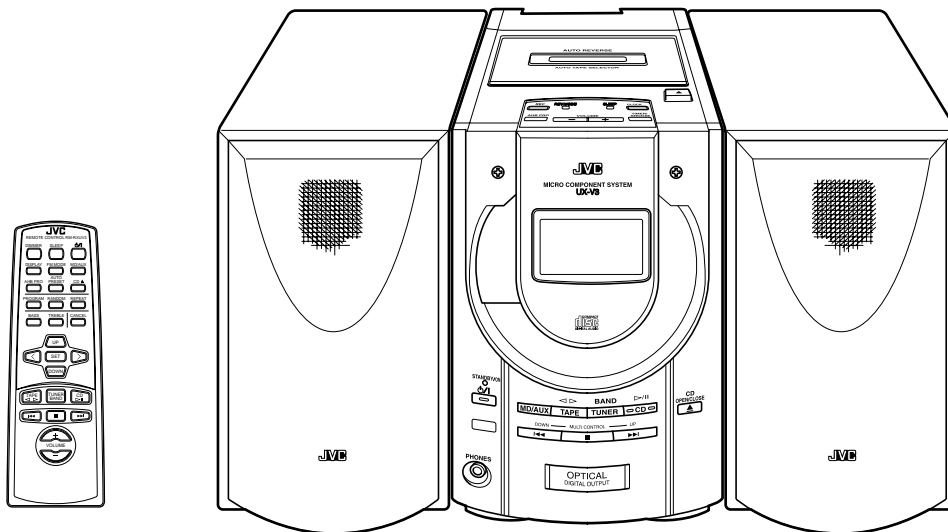

COMPACT
disc
DIGITAL AUDIO

INSTRUCTIONS
BEDIENUNGSANLEITUNG
MANUEL D'INSTRUCTIONS
GEBRUIKSAANWIJZING
MANUAL DE INSTRUCCIONES
ISTRUZIONI

For Customer Use:

Enter below the Model No. and Serial No. which are located either on the rear, bottom or side of the cabinet. Retain this information for future reference.

Model No.

Serial No.

LVT0215-001A

[E]

Warnings, Cautions and Others / Warnung, Achtung und sonstige Hinweise / Mises en garde, précautions et indications diverses / Waarschuwingen, voorzorgen en andere mededelingen / Avisos, precauciones y otras notas / Avvertenze e precauzioni da osservare

Caution — ⚡ switch!

Disconnect the mains plug to shut the power off completely. The ⚡ switch in any position does not disconnect the mains line. The power can be remote controlled.

Achtung — ⚡ Schalter!

Den Netzstecker aus der Steckdose ziehen, um die Stromversorgung vollkommen zu unterbrechen. Der Schalter ⚡ unterbricht in keiner Stellung die Stromversorgung vollkommen. Die Stromversorgung kann mit der Fernbedienung ein- und ausgeschaltet werden.

Attention — Commutateur ⚡!

Déconnecter la fiche de secteur pour couper complètement le courant. Le commutateur ⚡ ne coupe jamais complètement la ligne de secteur, quelle que soit sa position. Le courant peut être télécommandé.

Voorzichtig — ⚡ schakelaar!

Om de stroomtoevoer geheel uit te schakelen, trekt u de stekker uit het stopcontact. Anders zal er altijd een geringe hoeveelheid stroom naar het apparaat lopen, ongeacht de stand van de ⚡ schakelaar. U kunt het apparaat ook met de afstandsbediening aan- en uitschakelen.

Precaución — Interruptor ⚡!

Desconectar el cable de alimentación para desactivar la alimentación totalmente. Cualquier que sea la posición de ajuste del interruptor ⚡, la alimentación no es cortada completamente. La alimentación puede ser controlada remotamente.

Attenzione — L'interruttore ⚡!

Disinserire la spina del cavo di alimentazione dalla presa della rete elettrica per staccare completamente l'alimentazione. L'interruttore ⚡ in nessuna posizione stacca la linea di alimentazione elettrica principale. È possibile il controllo remoto dell'alimentazione.

Per l'Italia:

"Si dichiara che il questo prodotto di marca JVC è conforme alle prescrizioni del Decreto Ministeriale n.548 del 28/08/95 pubblicato sulla Gazzetta Ufficiale della Repubblica Italiana n.301 del 28/12/95."

CAUTION

To reduce the risk of electrical shocks, fire, etc.:

1. Do not remove screws, covers or cabinet.
2. Do not expose this appliance to rain or moisture.

ACHTUNG

Zur Verhinderung von elektrischen Schlägen, Brandgefahr, usw:

1. Keine Schrauben lösen oder Abdeckungen entfernen und das Gehäuse nicht öffnen.
2. Dieses Gerät weder Regen noch Feuchtigkeit aussetzen.

ATTENTION

Afin d'éviter tout risque d'électrocution, d'incendie, etc.:

1. Ne pas enlever les vis ni les panneaux et ne pas ouvrir le coffret de l'appareil.
2. Ne pas exposer l'appareil à la pluie ni à l'humidité.

VOORZICHTIG

Ter vermindering van gevaar voor brand, elektrische schokken, enz.:

1. Verwijder geen schroeven, panelen of de behuizing.
2. Stel het toestel niet bloot aan regen of vocht.

PRECAUCIÓN

Para reducir riesgos de choques eléctricos, incendio, etc.:

1. No extraiga los tornillos, los cubiertas ni la caja.
2. No exponga este aparato a la lluvia o a la humedad.

ATTENZIONE

Per ridurre il rischio di shock elettrici, incendi, ecc...

1. Non togliete viti, coperchi o la scatola.
2. Non esponete l'apparecchio alla pioggia e all'umidità.

Caution: Proper Ventilation

To avoid risk of electric shock and fire, and to prevent damage, locate the apparatus as follows:

- 1 Front:
 - No obstructions and open spacing.
- 2 Sides/ Top/ Back:
 - No obstructions should be placed in the areas shown by the dimensions below.
- 3 Bottom:
 - Place on the level surface. Maintain an adequate air path for ventilation by placing on a stand with a height of 10 cm or more.

Vorsicht: Ausreichende Belüftung

Zur Vermeidung von elektrischen Schlägen, Feuer und sonstigen Schäden sollte das Gerät unter folgenden Bedingungen aufgestellt werden:

- 1 Vorderseite:
 - Hindernisfrei und gut zugänglich.
- 2 Seiten- und Rückwände:
 - Hindernisfrei in allen gegebenen Abständen (s. Abbildung).
- 3 Unterseite:
 - Die Stellfläche muß absolut eben sein. Sorgen Sie für ausreichende Luftzufuhr durch Aufstellung auf einem Stand mit mindestens 10 cm Höhe.

Attention: Aération correcte

Pour prévenir tout risque de décharge électrique ou d'incendie et éviter toute détérioration, installez l'appareil de la manière suivante:

- 1 Avant:
 - Bien dégagé de tout objet.
- 2 Côtés/dessus/dessous:
 - Assurez-vous que rien ne bloque les espaces indiqués sur le schéma ci-dessous.
- 3 Dessous:
 - Posez l'appareil sur une surface plane et horizontale. Veillez à ce que sa ventilation correcte puisse se faire en le plaçant sur un support d'au moins dix centimètres de hauteur.

Voorzichtig: Goede ventilatie vereist

Om brand, elektrische schokken en beschadiging te voorkomen, moet u het toestel als volgt opstellen:

- 1 Voorkant:
 - Geen belemmeringen en voldoende ruimte.
- 2 Zijkanten/boven-/onderkant:
 - Geen belemmeringen plaatsen in de hieronder aangegeven zones.
- 3 Onderkant:
 - Op vlakke ondergrond plaatsen. Voldoende ventilatieruimte voorzien door het toestel op een onderstel met een hoogte van 10 cm of meer te plaatsen.

Precaucion: ventilación correcta

Para evitar el riesgo de descargas eléctricas e incendio y prevenir posibles daños, instale el equipo en un lugar que cumpla los siguientes requisitos:

- 1 Parte frontal:
 - Sin obstrucciones, espacio abierto.
- 2 Lados/parte superior/parte posterior:
 - No debe haber ninguna obstrucción en las áreas mostradas por las dimensiones de la siguiente figura.
- 3 Parte inferior:
 - Sítue el equipo sobre una superficie nivelada. Mantenga un espacio adecuado para permitir el paso del aire y una correcta ventilación, situando el equipo sobre un soporte de 10 o más cm de altura.

Attenzione: Per una corretta ventilazione

Per prevenire il rischio di scosse elettriche e di incendio ed evitare possibili danni, collocare le apparecchiature nel modo seguente:

- 1 Parte anteriore:
 - Nessun ostacolo e spazio libero.
- 2 Lati/Parte superiore/Retro:
 - Lasciare libere le zone indicate dalle dimensioni di seguito.
- 3 Base:
 - Collocare su una superficie piana. Consentire un'adeguata ventilazione dell'impianto appoggiandolo su un tavolino alto almeno 10 cm.

Front view
Vorderansicht
Face
Vooraanzicht
Vista frontal
Vista frontale

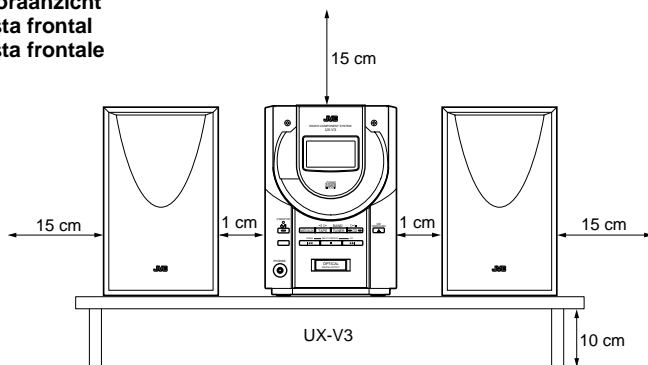

Side view
Seitenansicht
Côt
Zijaanzicht
Vista lateral
Vista laterale

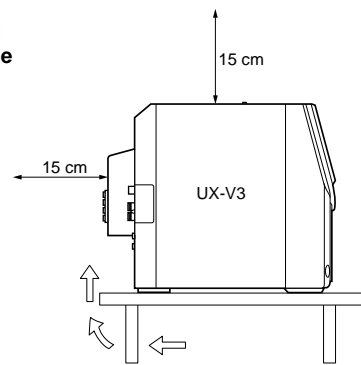

IMPORTANT FOR LASER PRODUCTS/ WICHTIGER HINWEIS FÜR LASER-PRODUKTE / IMPORTANT POUR LES PRODUITS LASER / BELANGRIJKE INFORMATIE VOOR LASERPRODUKTEN / IMPORTANTE PARA LOS PRODUCTOS LÁSER / IMPORTANTE PER I PRODOTTI LASER

REPRODUCTION OF LABELS/ANBRINGUNGSORTE FÜR LASER-PRODUKTE/REPRODUCTION DES ETIQUETTES/VERKLARING VAN DE LABELS/REPRODUCCIÓN DE ETIQUETAS/RIPRODUZIONE DELLE ETICHETTE

- | | |
|--|---|
| ① CLASSIFICATION LABEL, PLACED ON EXTERIOR SURFACE | ② WARNING LABEL, PLACED INSIDE THE UNIT |
| ① KLASSIFIZIERUNGSHINWEIS BEFINDET SICH AUF DER AUSSENSIETE | ② WARNETIKETTE IM GERÄTEINNEREN |
| ① ÉTIQUETTE DE CLASSIFICATION, PLACÉE SUR LA SURFACE EXTÉRIEURE | ② ETIQUETTE D'AVERTISSEMENT PLACÉE À L'INTERIEUR DE L'APPAREIL |
| ① CLASSIFICATIE-ETIKET AAN DE BUITENKANT VAN HET APPARAAT | ② WAARSCHUWINGSLABEL, IN HET APPARAAT |
| ① ETIQUETA DE CLASIFICACION, PROVISTA SOBRE LA SUPERFICIE EXTERIOR | ② ETIQUETA DE ADVERTENCIA, PEGADA EN EL INTERIOR DE LA UNIDAD |
| ① ETICHETTA DI CLASSIFICAZIONE POSTA ALL'ESTERNO | ② ETICHETTA DI AVVERTENZA, SITUATA ALL'INTERNO DELL'APPARECCHIO |

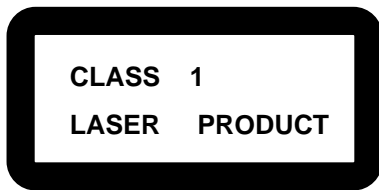

DANGER: Invisible laser radiation when open and interlock failed or defeated. AVOID DIRECT EXPOSURE TO BEAM. (e)	WARNING: Osynlig laserstrålning när denna del är öppnad och spårren är urkopplad. Betrakta ej strålen. (s)	ADVARSEL: Usynlig laserstrålning ved åbning, når sikkerhedsafbrydere er ude af funktion. Undgå udsættelse for stråling (d)	VARO: Avattaessa ja suo-jalukitus ohitettaessa olet alttiina näkymättömälle lasersäteilylle. Älä katso säteeseen. (f)
---	---	---	--

- | | |
|---|---|
| <ol style="list-style-type: none">1. CLASS 1 LASER PRODUCT2. DANGER: Invisible laser radiation when open and interlock failed or defeated. Avoid direct exposure to beam.3. CAUTION: Do not open the top cover. There are no user serviceable parts inside the Unit; leave all servicing to qualified service personnel. | <ol style="list-style-type: none">1. KLAS 1 LASERPRODUKT2. GEVAARLIJK: Onzichtbare laserstraling wanneer open en de beveiliging faalt of uitgeschakeld is. Voorkom het direct blootstaan aan de straal.3. VOORZICHTIG: De bovenkap niet openen. Binnenin het toestel bevinden zich geen door de gebruiker te repareren onderdelen: laat onderhoud over aan bekwam vakpersoneel. |
| <ol style="list-style-type: none">1. LASER-PRODUKT DER KLASSE 12. GEFAHR: Unsichtbare Laserstrahlung bei Öffnung und fehlerhafter oder beschädigter Spre. Direkten Kontakt mit dem Strahl vermeiden!3. ACHTUNG: Das Gehäuse nicht öffnen. Das Gerät enthält keinerlei Teile, die vom Benutzer gewartet werden können. Überlassen Sie Wartungsarbeiten bitte qualifizierten Kundendienst-Fachleuten. | <ol style="list-style-type: none">1. PRODUCTO LASER CLASE 12. PELIGRO: En el interior hay radiación láser invisible. Evite el contacto directo con el haz.3. PRECAUCIÓN: No abra la tapa superior. En el interior de la unidad no existen piezas reparables por el usuario; deje todo servicio técnico en manos de personal calificado. |
| <ol style="list-style-type: none">1. PRODUIT LASER CLASSE 12. ATTENTION: Radiation laser invisible quand l'appareil est ouvert ou que le verrouillage est en panne ou désactivé. Eviter une exposition directe au rayon.3. ATTENTION: Ne pas ouvrir le couvercle du dessus. Il n'y a aucune pièce utilisable à l'intérieur. Laisser à un personnel qualifié le soin de réparer votre appareil. | <ol style="list-style-type: none">1. PRODOTTO LASER CLASSE 12. PERICOLO: Radiazione laser invisibile quando l'apparecchio è aperto ed il dispositivo di sicurezza è guasto o disattivato. Evitare l'esposizione diretta ai raggi.3. ATTENZIONE: Non aprire il coperchio superiore. Non vi sono parti adoperabili dall'utente all'interno di questo apparecchio; lasciare tutti i controlli a personale qualificato. |

Thank you for purchasing the JVC Micro Component System.
 We hope it will be a valued addition to your home, giving you years of enjoyment.
 Be sure to read this instruction manual carefully before operating your new stereo system.
 In it you will find all the information you need to set up and use the system.
 If you have a query that is not answered by the manual, please contact your dealer.

Features

Here are some of the things that make your System both powerful and simple to use.

- The controls and operations have been redesigned to make them very easy to use, freeing you to just enjoy the music.
 - With JVC's **COMPU PLAY** you can turn on the System and automatically start the Radio, Cassette deck or CD Player with a single touch.
- The System incorporates Active Hyper Bass PRO circuitry to faithfully reproduce low frequency sounds.
- A 45-station preset capability (30 FM and 15 AM (MW/LW)) in addition to auto-seek and manual tuning.
- Versatile CD options include repeat, random and program play.
- Timer functions; Daily Timer and Sleep Timer.
- Auto-reverse tape function.
- You can connect various external units, such as an MD recorder.



How This Manual Is Organized

- Basic information that is the same for many different functions - e.g. setting the volume - is given in the section 'Common Operations', and not repeated under each function.
- The names of buttons/controls and display messages are written in all capital letters: e.g. TUNER BAND, "NO DISC".
- System functions are written with an initial capital letter only: e.g. Normal Play.

Use the table of contents to look up specific information you require.

We've enjoyed making this manual for you, and hope it serves you in enjoying the many features built into your System.

IMPORTANT CAUTIONS

1. Installation of the System

- Select a place which is level, dry and neither too hot nor too cold. (Between 5°C and 35°C or 41°F and 95°F.)
- Leave sufficient distance between the System and a TV.
- Do not use the System in a place subject to vibrations.

2. Power cord

- Do not handle the power cord with wet hands!
- Some power is always consumed as long as the power cord is connected to the wall outlet.
- When unplugging the System from the wall outlet, always pull the plug, not the power cord.

3. Malfunctions, etc.

- There are no user serviceable parts inside. In case of system failure, unplug the power cord and consult your dealer.
- Do not insert any metallic object into the System.

Table of Contents

Features	1	Using the Timers	16
How This Manual Is Organized	1	Care And Maintenance	18
IMPORTANT CAUTIONS	1	Troubleshooting	19
Getting Started	2	Specifications	20
Common Operations	6		
Using the Tuner	8		
Using the CD Player	10		
Using the Cassette Deck (Listening to a Tape)	12		
Using the Cassette Deck (Recording)	13		
Using External Equipments	15		

Getting Started

Accessories

Make sure that you have all of the following items, which are supplied with the System.

- Power Cord (1)
- AM Loop Antenna (1)
- Remote Control (1)
- Batteries (2)
- FM Wire Antenna (1)

If any of these items are missing, contact your dealer immediately.

How To Put Batteries In the Remote Control

Match the polarity (+ and -) on the batteries with the + and - markings in the battery compartment.

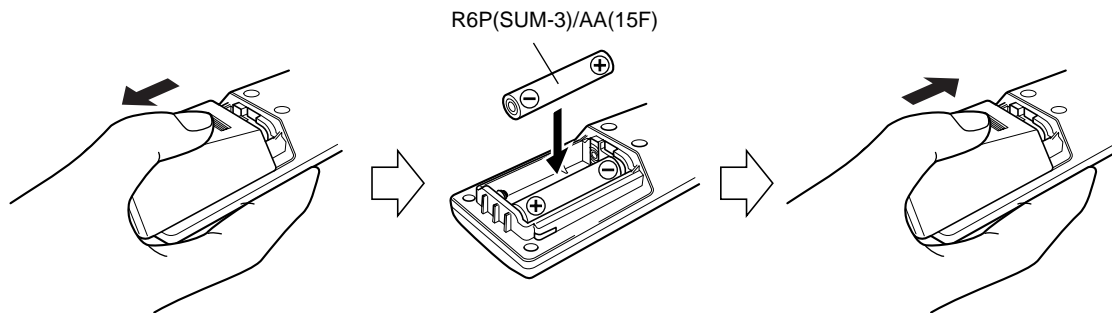

CAUTION: Handle batteries properly.

To avoid battery leakage or explosion:

- Remove batteries when the Remote Control will not be used for a long time.
- When you need to replace the batteries, replace both batteries at the same time with new ones.
- Don't use an old battery with a new one.
- Don't use different types of batteries together.

Using the Remote Control

The Remote Control makes it easy to use many of the functions of the System from a distance of up to 7m (23 feet) away. You need to point the Remote Control at the remote sensor on the System's front panel.

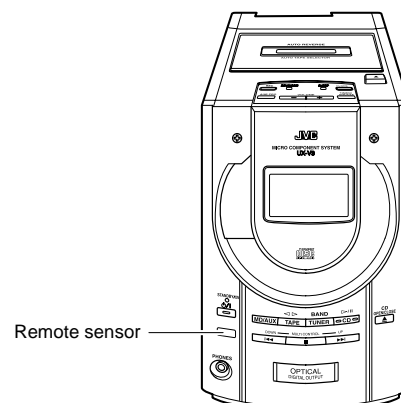

CAUTION: Make all connections before plugging the System into an AC power outlet.

Connecting the FM Antenna

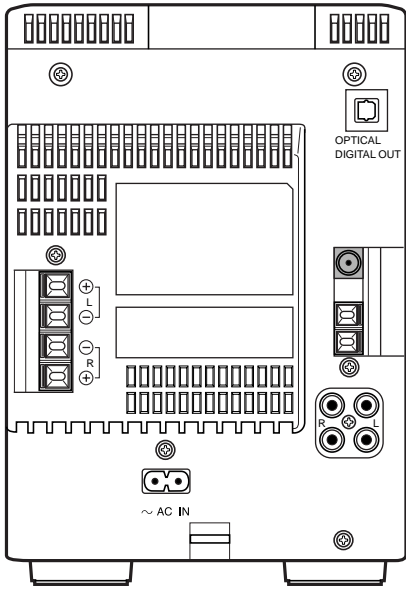

Using the Supplied Wire Antenna

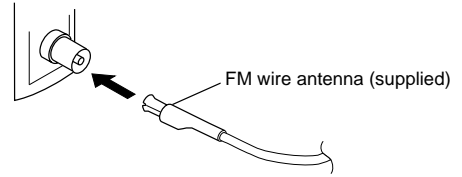

Using the Coaxial Type Connector (Not Supplied)

A 75-ohm antenna with coaxial type connector (IEC or DIN45 325) should be connected to the FM 75-ohm COAXIAL terminal.

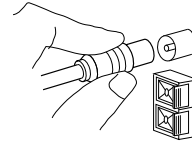

If reception is poor, connect the outside antenna.

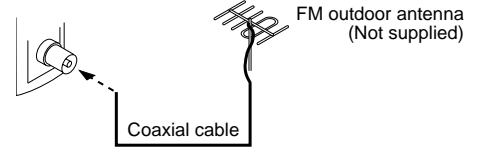

Note: Before attaching a 75 ohm coaxial lead (the kind with a round wire going to an outside antenna), disconnect the supplied FM Wire Antenna.

Connecting the AM (MW/LW) Antenna

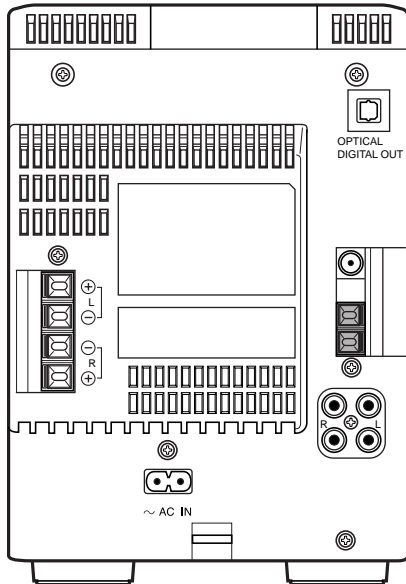

AM loop antenna (Supplied)

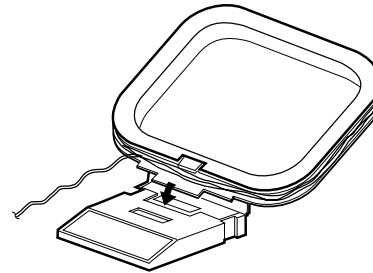

Attach the AM loop to its base by snapping the tabs on the loop into the slot in the base.

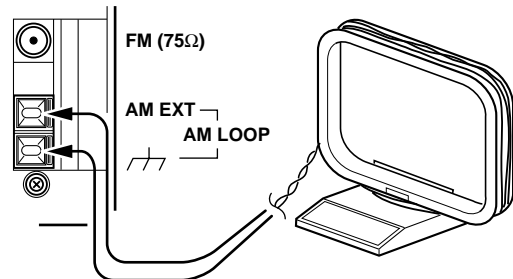

Turn the loop until you have the best reception.

CAUTION: To avoid noise, keep antennas away from the System, the connecting cord and the AC power cord.

CAUTION: Make all connections before plugging the System into an AC power outlet.

Connecting the Speakers

For each speaker, connect one end of the speaker wire to the speaker terminals on the back of the System.

1. Open each of the terminals and insert the speaker wires firmly, then close the terminals.
2. Connect the red (+) and black (-) wires of the right side speaker to the red (+) and black (-) terminals marked R on the System. Connect the red (+) and black (-) wires of the left side speaker to the red (+) and black (-) terminals marked L on the System.

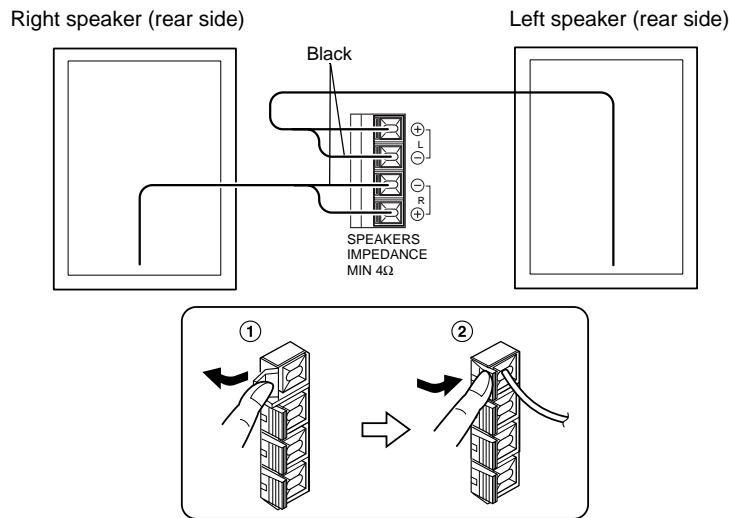

CAUTION: A TV may display irregular colors if located near the speakers. If this happens, set the speakers away from the TV.

Connecting External Equipment

Connect signal cords (not supplied) between the System's LINE IN (AUX)/LINE OUT terminals and the output/input terminals of the external MD recorder, tape deck, etc.

You can then listen to the external source through the System, or record the System's CD player, cassette tape, or tuner to the external unit.

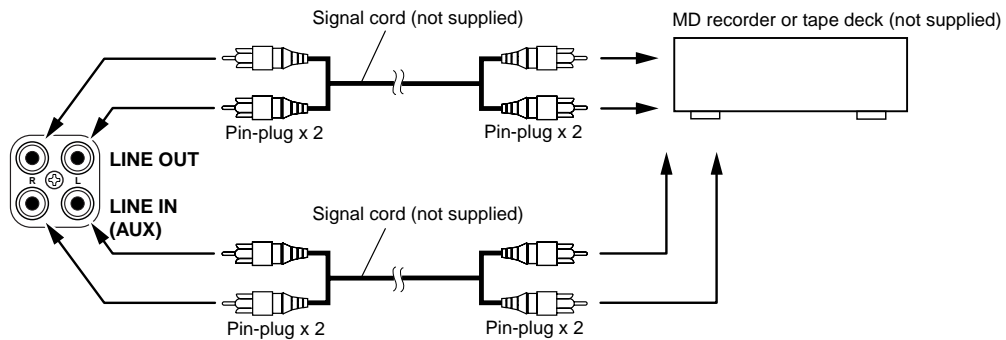

Connecting an MD Recorder, etc (Digital Output)

Unplug the cap and connect an optical digital cord (not supplied) between the System's OPTICAL DIGITAL OUT terminal and the input terminal of the MD recorder, etc.

You can record the digital output signal from the System's CD Player to the MD recorder, etc.

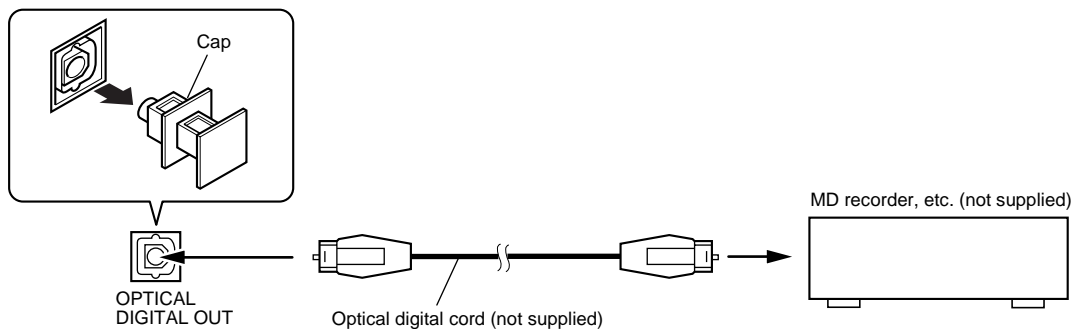

Connecting the AC Power Cord

Firmly insert the supplied AC power cord into the AC inlet on the back of the Unit.

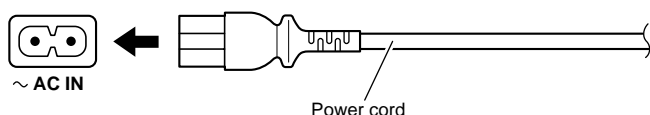

CAUTIONS:

- **ONLY USE THE JVC POWER CORD PROVIDED WITH THIS SYSTEM TO AVOID MALFUNCTION OR DAMAGE TO THE SYSTEM.**
- **BE SURE TO UNPLUG THE POWER CORD FROM THE OUTLET WHEN GOING OUT OR WHEN THE SYSTEM IS NOT IN USE FOR AN EXTENDED PERIOD OF TIME.**

Now you can plug the AC power cord into the wall outlet, and your System is at your command!

COMPU PLAY

JVC's COMPU PLAY feature lets you control the most frequently used System functions with a single touch.

With One Touch Operation you can play a CD, a tape, turn on the radio, or listen to an external equipment with a single press of the play button for that function. One Touch Operation turns the power on for you, then starts the function you have specified. If the System is not ready (no CD in place), the System still powers on so you can insert a CD.

How One Touch Operation works in each case is explained in the section dealing with that function.

The COMPU PLAY buttons are:

On the Unit

CD ▷|| button
TUNER BAND button
TAPE ◀ ▷ button
MD/AUX button

On the Remote Control

CD ▷|| button
TUNER BAND button
TAPE ◀ ▷ button
MD/AUX button

AUTOMATIC POWER ON

The System automatically turns on with the following operation.

- When you press the CD ▲ button, the System automatically turns on and the CD cover opens to allow CD insertion. However, this operation does not change the function to CD.
When you press the ⏻ button to turn off the System, the CD cover will automatically closed if it is opened.

Common Operations

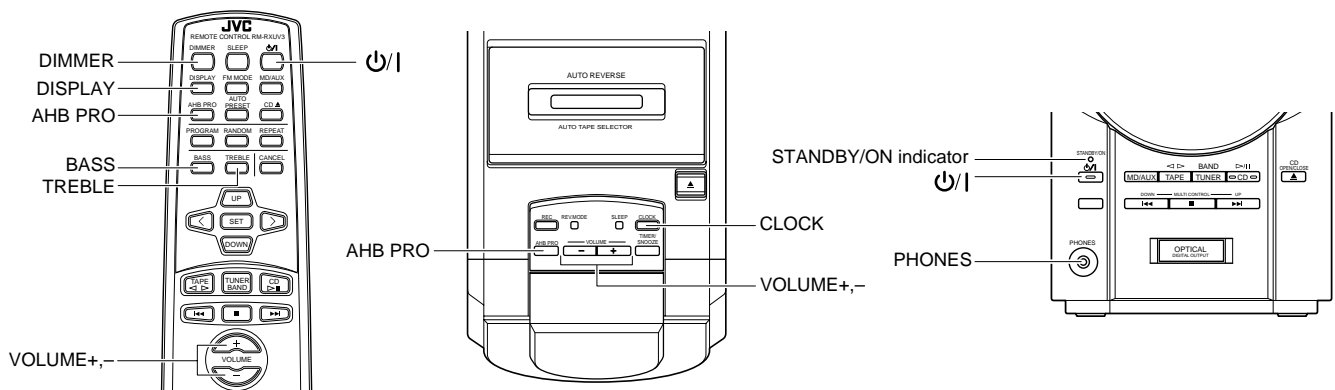

Turning the Power On and Off

Turning the System On

Press the O/I button.

The display comes on and “HELLO” is displayed once. The STANDBY/ON indicator lights in green.

The System comes on ready to continue in the mode it was in when the power was last turned off.

- For example, if the last thing you were doing was listening to a CD, you are now ready to listen to a CD again. If you wish, you can change to another source.
- If you were listening to the Tuner last, the Tuner comes on playing the station it was last set to.

Turning the System Off

Press the O/I button again.

“GOOD BYE” is displayed and the display goes out, except for the clock display. The STANDBY/ON indicator lights in red.

- Some power is always consumed even though power is turned off (called Standby Mode).
- To switch off the System completely, unplug the AC power cord from the wall outlet. When you unplug the AC power cord, the clock will be reset to 0:00 after about 20 minutes.

Adjusting the Brightness (DIMMER)

You can adjust the brightness of the backlighting for the display.

When the System is Turned On

To make the brightness of the backlighting darker, press the DIMMER button on the Remote Control.

To make the brightness brighter, press the DIMMER button on the Remote Control again.

When the System is Turned Off (STANDBY MODE)

To turn on the backlighting, press the DIMMER button on the Remote Control. The brightness is the same as for darker one mentioned above.

To turn off the backlighting, press the DIMMER button on the Remote Control again.

Adjusting the Volume

Press the VOLUME + button to increase the volume or press the VOLUME – button to decrease it.



You can adjust the volume level between 0 and 50.

CAUTION: DO NOT turn on the System and/or start playing any source without first setting the VOLUME control to minimum, as a sudden blast of sound could damage your hearing, speakers and/or headphones.

For private listening

Connect a pair of headphones to the PHONES jack. No sound comes out of the speakers.

Be sure to turn down the volume before connecting or putting on headphones.

Reinforcing the Bass Sound (AHB PRO)

You can reinforce the bass sound to maintain rich, full bass at low volume (you can use this effect only for playback):

To get the effect, press the AHB (Active Hyper Bass) PRO button.

The “BASS” indicator lights up on the display.

To cancel the effect, press the button again.

The “BASS” indicator goes out.

Tone Control (BASS/TREBLE)

You can control the tone by changing the bass and treble.

The analog clock acts to display the bass and treble settings.

By pressing either the BASS or TREBLE button on the Remote Control, you can visually see the current tone control settings.

Examples:

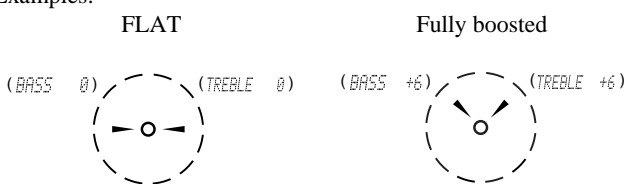

BASS Control

You can adjust the bass level (low frequency range level) between -6 and +6. (0: Flat)

1. Press the BASS button on the Remote Control.

2. Press the UP or DOWN button on the Remote Control to adjust the bass level.

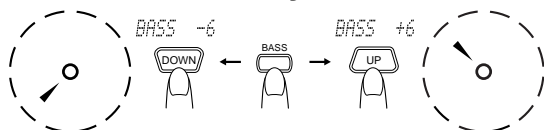

TREBLE Control

You can adjust the treble level (high frequency range level) between -6 and +6. (0: Flat)

1. Press the TREBLE button on the Remote Control.

2. Press the UP or DOWN button on the Remote Control to adjust the treble level.

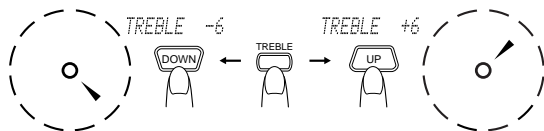

Showing the Time (DISPLAY)

In Standby mode, the digital clock and analog clock appear on the display at the same time. Meanwhile, only the analog clock is displayed when a music source is selected. Namely, you can see the analog clock at all times.

When the System is turned on, you can display the digital clock at any time.

To display the digital clock, press the CLOCK button on the Unit or DISPLAY button on the Remote Control.

To return to the previous mode, press the same button again.

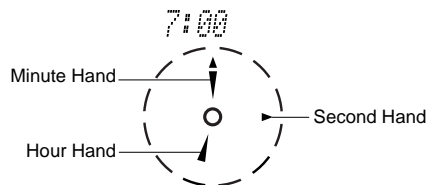

Note: To let work the clock, you need to set the clock beforehand. (See “Setting the Clock” on page 16.)

Using the Tuner

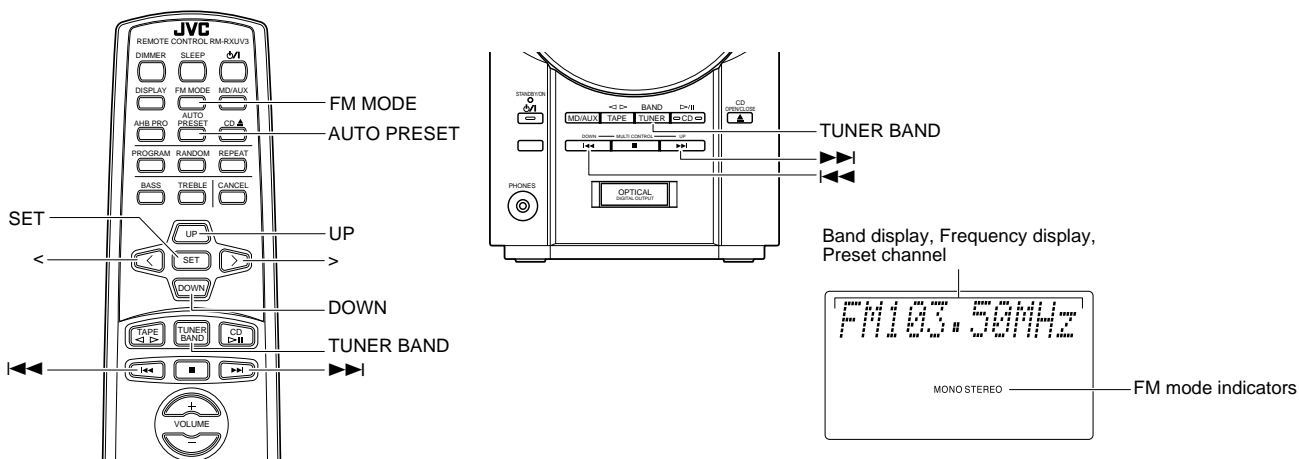

When the System is in use, the display shows other items as well.
For simplicity, we show here only the items described in this section.

You can listen to FM and AM (MW/LW) stations. Stations can be tuned in manually, automatically, or from preset memory storage.

■ Before listening to the radio:

- Make sure that both the FM and AM (MW/LW) antennas are correctly connected. (See page 3).

One Touch Radio

Just press the TUNER BAND button to turn on the System and start playing the station you were last tuned to.

- You can switch from any other sound source to the radio by pressing the TUNER BAND button.

Tuning In a Station

1. Press the TUNER BAND button.

The Band and Frequency you were last tuned to appear on the display.

(If the last station was selected using the preset number, the preset number appears first.)

Each time you press the button, the band alternates between FM and AM (MW/LW).

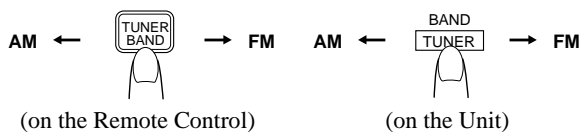

2. Select a station using one of the following methods.

■ Manual Tuning

Press the or button on the Unit or the Remote Control repeatedly to move from frequency to frequency until you find the station you want.

OR

■ Auto Tuning

If you press and hold the or button on the Unit or the Remote Control for one second or more, the frequency changes down, or up, automatically until a station is found.

OR

■ Preset Tuning using the Remote Control (Possible only after presetting stations)

Select the desired preset number using the Up, Down, > and < button on the Remote Control. After 1 second the display will show the preset number's band and frequency.

Example: Press the UP button until the preset number 12 "P12" appears.

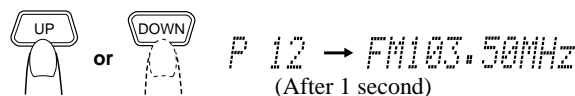

Presetting Stations

You can preset up to 30 FM stations and up to 15 AM (MW/LW) stations using the Remote Control.

Note: Preset numbers may have been set to factory test frequencies prior to shipment. This is not a malfunction. You can preset the stations you want into memory by following one of the presetting methods below.

Manual Presetting

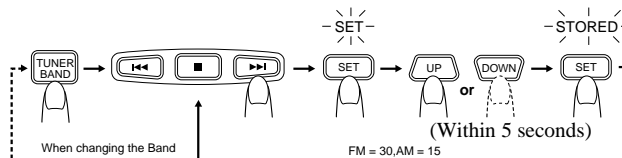

1. Select a band by pressing the TUNER BAND button.

2. Press the or button to tune in a station.

3. Press the SET button.

"SET" will blink for 5 seconds.

Within 5 seconds, proceed to the next step.

When the display returns to the one set in STEP2 after 5 seconds, press the SET button again.

4. Press the UP, DOWN, >, or < button within 5 seconds to select the preset number.

UP or > button: Increases the preset number by 1.

DOWN or < button: Decreases the preset number by 1.

- When the > or < button is kept pressed, the preset number changes rapidly.

5. Press the SET button within 5 seconds.

“STORED” appears and after 2 seconds, the display returns to the broadcast frequency display.

6. Repeat above steps 1 to 5 for each station you want to store in memory with a preset number.

To change the preset stations, repeat the same steps as above.

Auto Presetting

In each band, you can automatically preset FM-30, AM (MW/LW)-15 stations. Preset numbers will be allocated as stations are found, starting from the lowest frequency and moving up the frequency.

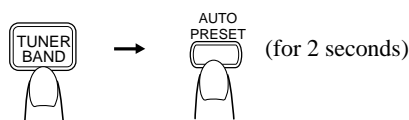

1. Select a band by pressing the TUNER BAND button.

2. Press the AUTO PRESET button on the Remote Control for more than two seconds.

3. Repeat steps 1-2 for the other band.

- If you want to change the preset stations, carry out the Manual Presetting for the desired preset numbers.

CAUTION: Even if the system is unplugged or if the power failure occurs, the preset stations will be stored for about 24 hours. However, in case the preset stations are erased, you will need to preset the stations again.

To Change the FM Reception Mode

When you are tuned into an FM stereo broadcast, the “STEREO” indicator lights up and you can hear stereo effects.

If an FM stereo broadcast is hard to receive or noisy, you can select Monaural mode. Reception improves, but you lose any stereo effect.

Press the FM MODE button on the Remote Control so that the “MONO” indicator lights up on the display.

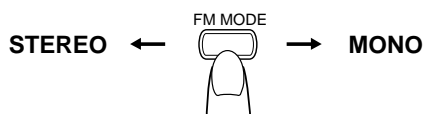

To restore the stereo effect, press the FM MODE button on the Remote Control so that the “MONO” indicator goes off.

Using the CD Player

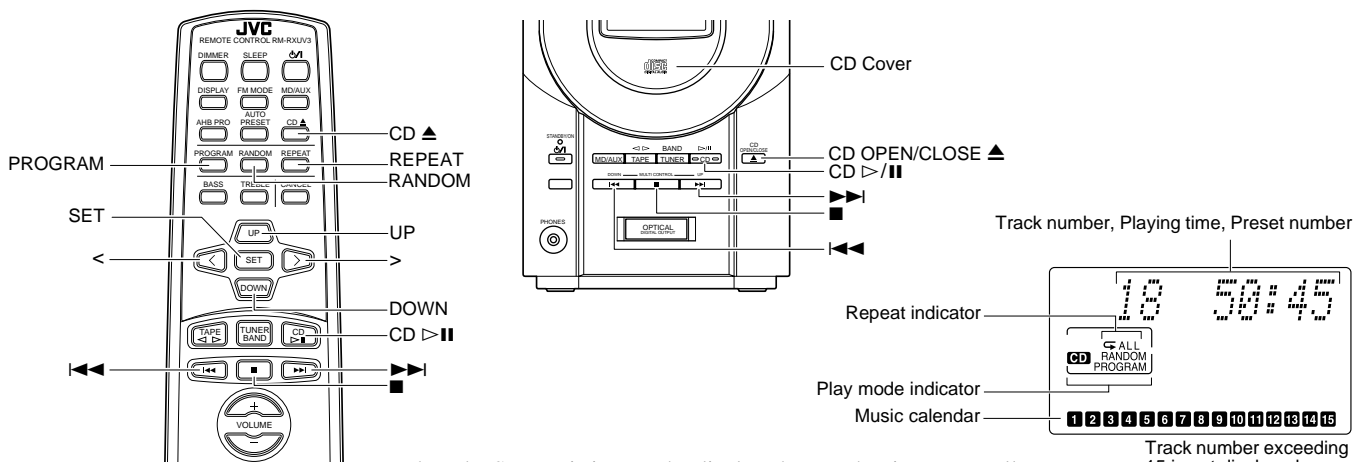

When the System is in use, the display shows other items as well. For simplicity, we show here only the items described in this section.

You can use Normal, Random, Program or Repeat Play. Repeat Play can repeat all the tracks or just one of the tracks on the CD. Here are the basic things you need to know to play a CD and locate the different tracks on it.

The Quickest Way To Start a CD Is With the One Touch Operation

- Press the CD ▷/|| button on the Unit or the Remote Control.
- The power is automatically turned on. If a CD is already inserted, it will start playing from the first track.
- If no CD is inserted, "NO DISC" appears on the display and the CD Player remains in Stop mode.

To Insert a CD

- 1. Press the CD OPEN/CLOSE ▲ button on the Unit (or the CD ▲ button on the Remote Control.)**

The CD cover opens.

- 2. Place a CD, with its label side out as shown below. Press down on the CD's center until you hear a click.**

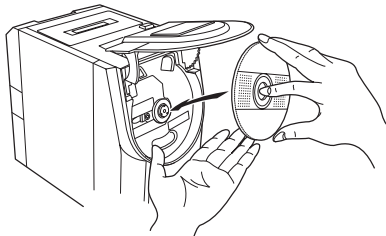

- 3. Press the CD OPEN/CLOSE ▲ button (or CD ▲ button) again to close the CD cover.**

- To close the CD cover and play the CD, you can just press the CD ▷/|| button.
- You can place an 8 cm (3") CD without an adaptor.
- If the CD cannot be read correctly (because it is scratched, for example), "0 0:00" appears on the display.
- You can insert a CD while listening to the other source.

CAUTIONS:

- **DO NOT try to open or close the CD cover by hands as it will be damaged.**

- **When you place or take out a CD, do not let it fall. Also, be careful not to scratch your fingers with a CD cover.**

To Unload a CD

Take out the CD as shown below.

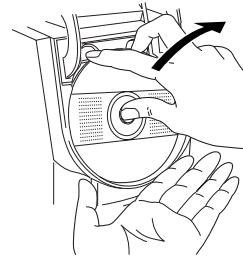

- To unload an 8 cm (3") CD, use the concavity to make removal easier.

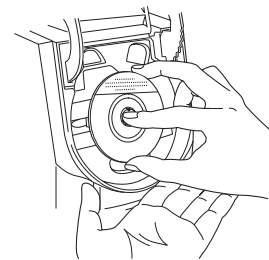

Basics of Using the CD Player-Normal Play

To Play a CD

- 1. Insert a CD.**
- 2. Press the CD ▷/|| button.**

The first track of the CD begins playing.

1 0:05
| |
Track number Playback time

- The track number that has already played disappears from the music calendar.
- The CD Player automatically stops when the last track of the CD has finished playing.

To stop playing the CD, press the ■ button.
The following information for the CD is displayed.

10 50:45
Total track number Total playback time

To stop playing and remove the CD, press the CD OPEN/CLOSE ▲ button on the Unit or CD ▲ button on the Remote Control to open the CD cover.

To pause, press the CD ▷|| button. The playback time blinks on the display.

To cancel pause, press the same button again. Play continues from the point where it was paused.

To Select a Track or Passage within a Track

During playback, press the ◀ or ▶ (< or >) button to select the track you want.

The selected track starts playing.

- Press the ▶ or > button once to skip to the beginning of the next track.
- Press the ◀ or < button to skip to the beginning of the track being played. Press twice quickly to skip to the beginning of the previous track.
- When the > or < button on the Remote Control is kept pressed, the track continuously skips.

Search Play

Holding down the ◀ or ▶ button, during playback, will fast forward/backwards the CD so you can quickly find a particular passage in the track you are listening to.

Programming the Playing Order of the Tracks

You can program the playing order of the tracks using the Remote Control.

- You can program up to 20 tracks in any desired order including the same tracks.
- You can only make a program when the CD Player is stopped.

1. Insert a CD.
2. Press the CD ▷|| button.
3. Press the ■ button to stop the CD.
4. Press the PROGRAM button.

The System enters the programming mode and the “CD PROGRAM” indicator lights up.

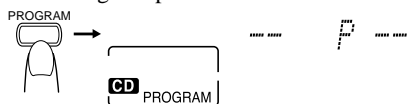

5. Press the UP, DOWN, >, or < button to select the track to program.

UP or > button: Increases the track number by 1.

DOWN or < button: Decreases the track number by 1.

- When the > or < button is kept pressed, the track number changes rapidly.

6. Press the SET button.

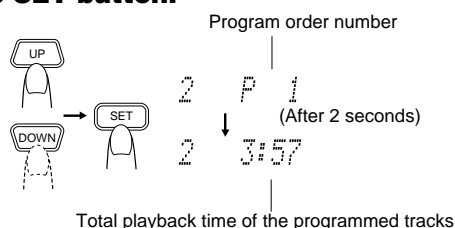

7. Repeat steps 5 and 6 to select the other tracks for the program.

You can see the total playback time of programmed tracks on the display. Also, you can see the programmed tracks on the music calendar.

8. Press the CD ▷|| button.

The System plays the tracks in the order you have programmed them.

- You can skip to a particular program track by pressing the ◀ or ▶ button during Program Play.
- To stop playing, press the ■ button once.

To confirm the programmed tracks while the CD player is stopped, each time press the ◀ or ▶ button; the tracks making up the program will successively be displayed in the programmed order.

To delete all the tracks in the program, in stop mode, press the ■ button. Pressing the CD ▲ button to open the CD cover will also clear the programmed tracks.

To exit the program mode once, while the CD Player is stopped, press the PROGRAM button to light off the “CD PROGRAM” indicator.

Notes:

- If the total playback time of the programmed tracks exceeds 99 minutes 59 seconds, the total playback time will go out on the display.
- If you try to program the 21th track, “MEMORY FULL” appears on the display for about 2 seconds.

To Modify the Program

Modify the contents of the program while the CD Player is stopped. Each time you press the CANCEL button, the last track in the program is deleted. To add new tracks to the end of the program, repeat above steps 5 to 7.

Random Play

The tracks will play in no special order when you use this mode.

1. Press the RANDOM button on the Remote Control.

The “CD RANDOM” indicator lights up on the display.

2. Press the CD ▷|| button.

The tracks are played in random order.

To skip a track during playback, press the ▶ button to jump to the next track in the random sequence. Press the ◀ button to jump back to the start of a track being played.

To exit Random Play mode, while the CD Player is stopped, press the RANDOM button to light off the “CD RANDOM” indicator and carry out Normal Play, or press the CD ▲ button to open the CD cover.

Repeating Tracks

You can set the program or individual track playing to repeat as many times as you like.

Press the REPEAT button on the Remote Control.

The Repeat indicator changes with each press of the button, as shown below.

☐ → ☐ ALL → blank display → (back to the beginning)

☐ : Repeats one track.

☐ ALL : In Normal Play mode, repeats all the tracks.

In Program Play mode, repeats all the tracks in the program.

In Random Play mode, repeats all the tracks in random order.

To exit Repeat mode, press the REPEAT button until the Repeat indicator on the display goes out.

- In Random Play, as a matter of course, ☐ cannot be selected.
- Repeat mode remains in effect even when you change the play mode.

Using the Cassette Deck (Listening to a Tape)

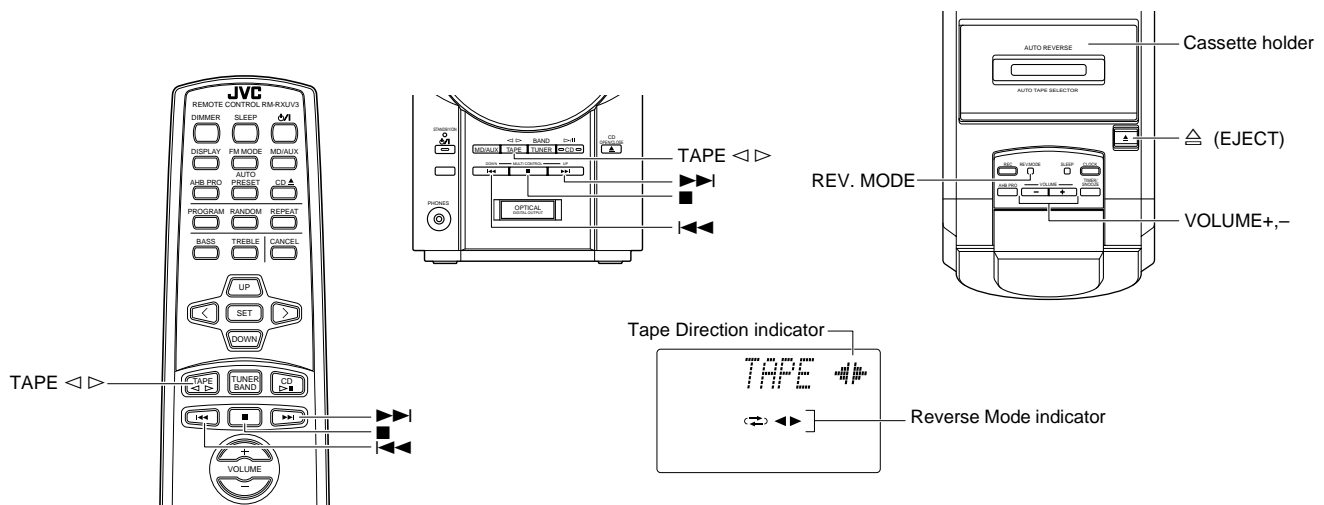

When the System is in use, the display shows other items as well. For simplicity, we show here only the items described in this section.

The Cassette Deck allows you to play and record audio tapes.

- With Automatic Tape Detection, you can listen to type I, II or IV tapes without having to change any settings.

The use of tapes longer than 120 minutes is not recommended, since characteristic deterioration may occur and these tapes easily jam in the pinch-rollers and the capstans.

One Touch Play

By pressing the TAPE $\triangleleft \triangleright$ button on the Unit or the Remote Control, the Unit will come on, "TAPE" appears in the display, and if a tape is in the deck, it will start to play. If no tape is loaded, "NO TAPE" appears on the display, the Unit will come on and wait for you to insert a tape, or select another function.

Regular Play

When the power is already on, you can use this basic procedure:

1. Press the \triangle (EJECT) button.
2. When the cassette holder opens, put the cassette in, with the side you want to listen facing up.
 - If the cassette holder does not open, turn the Unit off, then back on and press the \triangle (EJECT) button again.

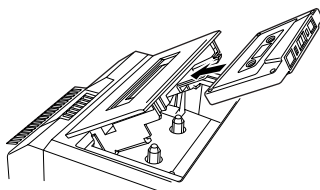

3. Close the holder gently until it clicks.

4. Press the TAPE $\triangleleft \triangleright$ button.

The tape is played in the direction shown by the Tape Direction indicator.

5. If you need to change the playback direction, press the TAPE $\triangleleft \triangleright$ again.

The opposite side Tape Direction indicator lights up and the tape playback direction changes.

To stop playing, press the ■ button.

To remove the tape, stop the tape, and press the \triangle (EJECT) button.

To Fast-Wind A Tape

- Press the $\triangleright \triangleright \triangleright$ or $\triangleleft \triangleleft \triangleleft$ button on the Unit or the Remote Control to fast-wind the tape. $\triangleright \triangleright \triangleright$ or $\triangleleft \triangleleft \triangleleft$ indicator of the tape fast-wind direction appears on the display.

- The Cassette Deck automatically stops when the tape reaches its end.

Reverse Mode

You can set a tape to play just one side, both sides in succession, or both sides continuously.

Press the REV. MODE button on the Unit.

The indicator changes with each press of the button as shown.

$\triangleleft \rightarrow \triangleright \rightarrow \triangleleft \rightarrow \triangleright$ (back to the beginning)

- \triangleleft : The Cassette Deck automatically stops after playing one side of the tape.
- $\triangleleft \rightarrow \triangleright$: The Cassette Deck automatically stops after playing both sides of the tape. (Stops when playback in the \triangleleft direction is finished.)
- $\triangleleft \rightarrow \triangleright \rightarrow \triangleleft \rightarrow \triangleright$: The Cassette Deck continues to play both sides of the tape until the ■ button is pressed.

Using the Cassette Deck (Recording)

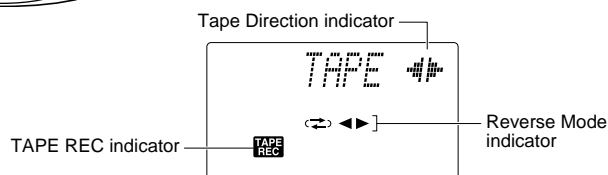
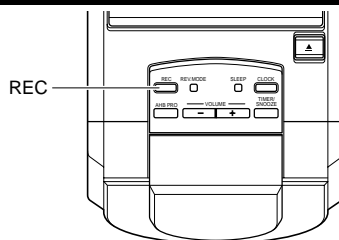
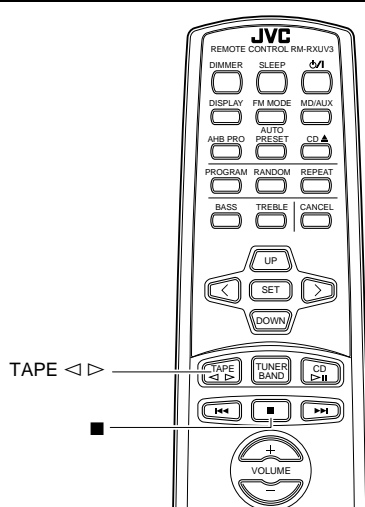

When the System is in use, the display shows other items as well. For simplicity, we show here only the items described in this section.

Recording onto a tape from any of the sound sources is simple. Just place a tape in the Cassette Deck, have the source ready, make one or two settings, and you're ready to record. For each source the procedure is a little bit different so we explain each separately. But first, here are a few things to make your recordings better.

Things To Know Before You Start Recording

- It may be unlawful to record or play back copyrighted material without the consent of the copyright owner.
- When you want to record onto both sides of a tape, you can set Reverse mode to do so. Recording automatically stops after recording in the \triangleleft direction. Therefore, make sure that the tape direction is \triangleright when recording with Reverse mode on.
- The recording level, which is the volume at which the new tape is being made, is automatically set correctly, so it is not affected by the VOLUME control on the System. Nor is it affected by adjusting the sound effects. Thus, during recording you can adjust the sound you are actually listening to without affecting the recording level.
- Two small tabs on the back of the cassette tape, one for side A and one for side B, can be removed to prevent accidental erasure or recording.

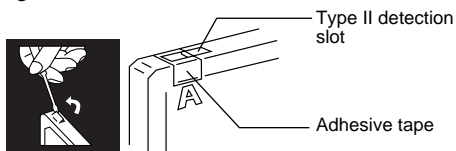

- To record on a cassette with the tabs removed, you must cover the holes with adhesive tape first. However, when a type II tape is used, only cover part of the hole as shown, since the other part of the hole (Type II detection slot) is used to detect the tape type.
- Type I and Type II tapes can be used for recording.

Note: At the start and end of cassette tapes, there is leader tape which cannot be recorded onto. Thus, when recording CDs or radio broadcasts, wind on the leader tape first to ensure getting the beginning of the recording.

CAUTION: If a recording you make has excessive noise or static, the Unit may have been too close to a TV which was on during the recording. Either turn off the TV or increase the distance between the TV and the System.

Standard Recording

You can record any sound source to tape as follows:

- 1. Insert a blank or erasable tape into the Cassette Deck and wind past the tape leader.**
- 2. Press the REV. MODE button on the Unit if you want to record on both sides of the tape.**

Press the button until the \rightleftarrows indicator is lit.

- When using Reverse mode, insert the tape so that it will be recorded in the forwards \triangleright direction.

- 3. Check the recording direction for the tape.**

Make sure that the Tape Direction indicator is the same as that for the tape in the Cassette Deck. If the directions are different, press the TAPE $\triangleleft \triangleright$ button to correct the tape direction and then press the ■ button to stop the tape.

- 4. Prepare the source, by, for example, tuning in a radio station or turning on connected auxiliary equipment.**

Note: For CD recording, refer to "CD Direct Recording" mentioned below.

- 5. Press the REC button on the Unit.**

The "TAPE REC" indicator lights up and the System begins recording.

- If the tab of the cassette tape is removed to prevent erasure or recording, "NO REC" will appear on the display.

Notes for using Reverse mode for recording

When recording in Reverse mode, the System automatically stops when it reaches the end of the reverse ◀ direction. To record on both sides of a tape, make sure that the recording direction for the tape inserted is forwards ▶, and that the Tape Direction indicator is also forwards ▶, before you start recording.

To Stop at Any Time During the Recording Process

Press the ■ button.

CD Direct Recording

Everything on the CD goes onto the tape in the order it is on the CD, or according to the order you have set in a program.

- 1. Insert a cassette into the Cassette Deck and wind past the tape leader.**
- 2. Insert a CD.**
- 3. Press the CD ▷/|| button on the Unit or on the Remote Control.**
- 4. Press the ■ button.**
 - If you want to record specific tracks only, program the tracks beforehand. You can check their total playback time on the display during programming. (See page 11.)
- 5. If you want to record on both sides of a tape, press the REV. MODE button on the Unit until the “↔” indicator is lit. Make sure that the recording direction for the tape and the Tape Direction indicator is correct. (See “Notes for using Reverse mode for recording”.)**
- 6. Choose whether to have pauses between recorded selections.**
 - If nothing is done, a non-recorded pause of about four seconds will be automatically left between selections.
 - If you do not want pauses between selections, do the following before proceeding to the next step.

Press the CD ▷/|| button on the Unit or the Remote Control twice.
The CD player enters Pause mode.
- 7. Press the REC button on the Unit.**

The “TAPE REC” indicator lights up and the System begins recording.

- If you make a recording with Reverse mode on, the Unit will record the last song at the end of the first side onto the next side from its beginning when the song has been recorded more than 12 seconds on the first side.
If the last song has been recorded less than 12 seconds, then the previous song will again be recorded on the next side as it will not be completely recorded on the first side because of leader tape.
- After the CD player has played the entire CD, or all the programmed tracks, the tape automatically stops.

To stop at any time during the recording process, press the ■ button. The tape stops after four seconds.

Note: When making SLEEP timer settings while doing CD Direct recording, set enough time to allow for the CD to finish playing, otherwise the power will go off before recording is completed.

One Track Recording

- 1. Insert a cassette into the Cassette Deck and wind past the tape leader.**
- 2. Play the track on the CD you wish to record.**
- 3. Press the REC button on the Unit.**

The CD player returns to the beginning of that track and the track is recorded on the tape. After recording, the CD player and Cassette Deck automatically stop.

Using External Equipments

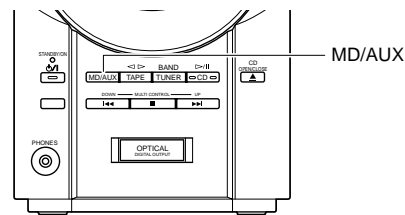
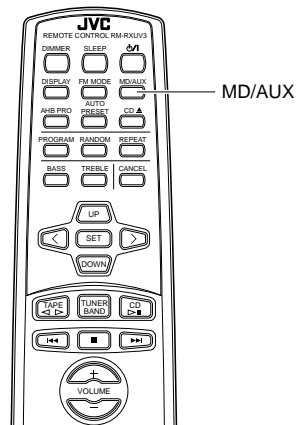

Listening to External Equipment

You can listen to external equipment such as MD recorder, turntable or other auxiliary.

■ First make sure that the external equipment is properly connected to the System. (See page 4).

1. Set the VOLUME control to the minimum position.

2. Press the MD/AUX button.

“AUX” appears on the display.

The word 'AUX' is displayed in a stylized, digital font on a screen, representing the selected external equipment mode.

3. Start playing the external equipment.

4. Adjust the VOLUME control to the desired listening level.

5. Apply sound effects, if you wish.

■ Press the AHB PRO button to reinforce the bass sound.

■ Press the BASS/TREBLE button on the Remote Control to control the tone. (See “Tone Control” on page 7.)

To exit MD/AUX mode, you will automatically switch out of MD/AUX mode when you select another source.

Note: For operation of the external equipment, refer to its Instructions.

Recording the System's source to External Equipment

You can record the System's source to external equipment which is connected to the LINE OUT or OPTICAL DIGITAL OUT terminals of the System, such as cassette deck or MD recorder, etc.

■ First make sure that the external equipment is properly connected to the System. (See page 4).

1. Play the System's CD Player, Cassette Deck, or tune into a station.

■ The recording level is not affected by the VOLUME level set by the System. Also it is not affected by the sound effects.

Note: For operation of the external equipment, refer to its Instructions.

Using the Timers

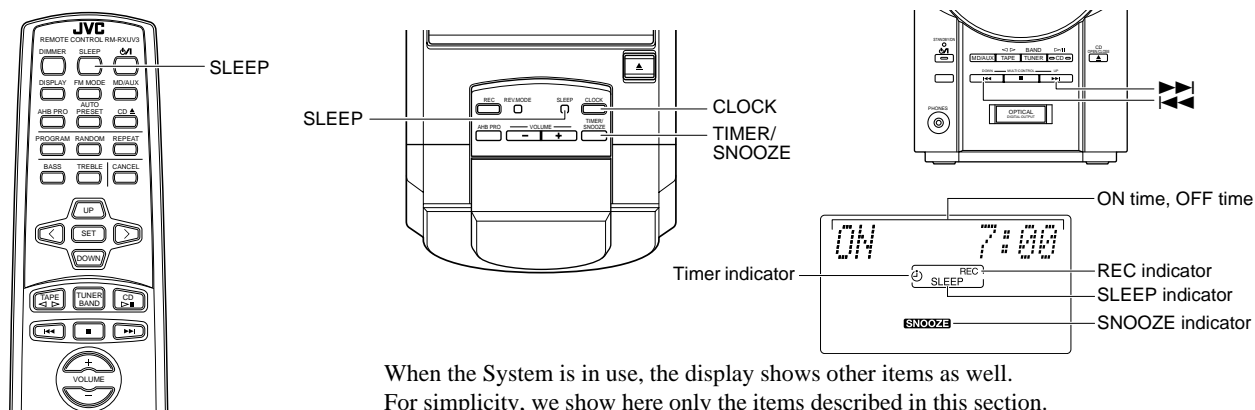

When the System is in use, the display shows other items as well.
For simplicity, we show here only the items described in this section.

The timers let you control listening and recording functions automatically.

Setting the Clock

- When you plug the AC power cord into the wall outlet, the time indication blinks on the display.

You can set the clock whether the System is on or off.

In addition to the digital clock, the analog clock also shows the time.

Notes:

- The clock must be correctly set for the timers to work.
- The procedure must be completed within two minutes. Otherwise, the setting is cleared and must be repeated from the beginning.

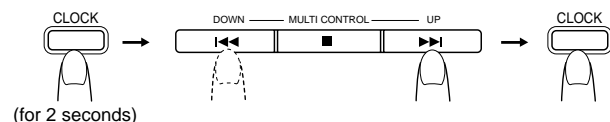

1. Press the **CLOCK** button on the Unit for more than two seconds.

The time indication rapidly blinks on the display.

2. Press the **▶▶** or **◀◀** button on the Unit to set the time.

Pressing the **▶▶** button moves the time forwards and pressing the **◀◀** button moves it backwards. Hold down the button to move the time rapidly.

3. Press the **CLOCK** button.

The selected time is set and the seconds start counting from 0.

CAUTION: If there is a power failure, the clock loses its setting after about 20 minutes. "0:00" blinks on the display and the clock must be reset.

Note: The clock may gain or lose one to two minutes per month.

Setting the Daily Timer

Once you have set the Daily Timer, the timer will be activated at the same time every day. It can be cancelled and re-activate whenever you wish.

The Timer indicator on the display shows when the Daily Timer you have set is in effect.

Note: Perform each setting within 30 seconds. Otherwise, setting is cleared and the procedure must be repeated from the beginning.

1. Press the **⏻** button to turn on the System.

2. Setting the ON time (Example: 12:15).

- Press the TIMER/SNOOZE button on the Unit.
The Timer indicator lights up and the current ON time blinks on the display.

- When the clock is not set, the "CLOCK" indicator and the "ADJUST" indicator appear alternately on the display. Set the clock at first.

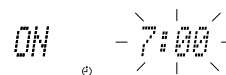

- Press the **▶▶** or **◀◀** button on the Unit to set the time you want the Unit to come on.

Pressing the **▶▶** button moves the time forwards and pressing the **◀◀** button moves it backwards. Hold down the button to move the time rapidly.

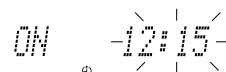

3. Setting the OFF time (Example: 13:15).

- Press the TIMER/SNOOZE button on the Unit.
The current OFF time blinks on the display.

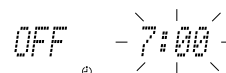

- Press the **▶▶** or **◀◀** button on the Unit to set the time you want the Unit to be turned off.

Pressing the **▶▶** button moves the time forwards and pressing the **◀◀** button moves it backwards. Hold down the button to move the time rapidly.

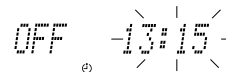

4. Selecting the music source.

- Press the TIMER/SNOOZE button on the Unit.
The "TUNER" blinks on the display.
- Press the **▶▶** or **◀◀** button to select the music source you want to listen to.
The display changes as shown below.
TUNER ↔ TUNER REC ↔ CD ↔ TAPE ↔ (back to the beginning)

- When you select the "TUNER REC", the "REC" indicator appears on the display.

5. Setting the volume level.

1. Press the TIMER/SNOOZE button on the Unit.
The current volume setting blinks on the display.
2. Press the ►► or ◀◀ button to select the volume level.
-- : The current volume level will be used.
0 to 50: When the timer is turned on, the Volume will be automatically set to the selected level.



6. Press the TIMER/SNOOZE button on the Unit.

The timer setting is completed and the display returns to the display before you set the timer. The timer indicator remains lit.

7. Before turning off the System, prepare the music source selected in step 4.

TUNER: Tune in to the desired station.

TUNER REC: Tune in to the desired station and insert a cassette tape for recording the station.

CD: Insert a CD.

TAPE: Insert a tape.

8. Press the button to turn off the System.

To cancel the timer, press the TIMER/SNOOZE button. The Timer indicator goes out on the display.

To re-activate the cancelled timer, press the TIMER/SNOOZE button to light the Timer indicator. Then, press the TIMER/SNOOZE button until the display returns to the original display. The Timer indicator should remain lit.

To confirm the timer settings, cancel the timer once by pressing the TIMER/SNOOZE button. Then, press the TIMER/SNOOZE button repeatedly, to see the current timer settings (ON time, OFF time, source, and volume).

To change the timer setting, repeat the setting procedure from the beginning.

- When the timer turns on, the Timer indicator starts blinking.

CAUTION: If the System is unplugged, or a power failure occurs, the timer setting will be lost. You will need to reset the clock first, then the timer.

5-Minute Snoozing

When the timer turns on the music source you can, if you wish, activate the 5-minute snoozing function to temporarily stop playback.

Press the TIMER/SNOOZE button on the Unit.

The “SNOOZE” indicator lights up on the display and the power is turned off for five minutes for snoozing.

Setting the SLEEP Timer

Use the Sleep Timer to turn the System off after a certain number of minutes when it is playing. By setting the Sleep Timer, you can fall asleep to music and know that your System will turn off by itself rather than play all night.

- You can only set the Sleep Timer when the System is on and a source is playing.

1. Play a CD, a cassette tape, or tune in to the desired station.

2. Press the SLEEP button.

The “SLEEP” indicator lights up.

- When the clock is not set, the “CLOCK” indicator and the “ADJUST” indicator appear alternately on the display. Set the clock at first.

3. Set the length of time you want the source to play before shutting off.

- Each time you press the SLEEP button, it changes the number of minutes shown on the display in this sequence:

10 → 20 → 30 → 60 → 90 → 120 → Cancelled → (back to the beginning)

After setting the number of minutes for the Sleep Timer, the display will stop blinking and return to the display as before setting the Sleep Timer. (The display is dimmed.)

The System is now set to turn off after the number of minutes you set.

To Confirm the Sleep Time

When the SLEEP button is pressed, the remaining sleep time is displayed. Wait until the display returns to the original display.

To Cancel the SLEEP Timer Setting

Press the SLEEP button until the “SLEEP” indicator goes out on the display.

Turning off the System also cancels the SLEEP Timer.

- If you are setting the Daily Timer, the System will be turned on at the set time to wake you up.

Care And Maintenance

Handle your CDs carefully, and they will last a long time.

Compact Discs

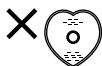

- Only CDs bearing this mark can be used with this System. However, continued use of irregular shape CDs (heart-shape, octagonal, etc.) can damage the System.



- Remove the CD from its case by holding it at the edges while pressing the case's center hole lightly.
- Do not touch the shiny surface of the CD, or bend the CD.



- Put the CD back in its case after use to prevent warping.
- Be careful not to scratch the surface of the CD when placing it back in the case.
- Avoid exposure to direct sunlight, temperature extremes, and moisture.



- A dirty CD may not play correctly. If a CD does become dirty, wipe it with a soft cloth in a straight line from center to edge.

CAUTION: Do not use any solvent (for example, conventional record cleaner, spray thinner, benzine, etc.) to clean a CD.

General Notes

In general, you will have the best performance by keeping your CDs and the mechanism clean.

- Store CDs in their cases, and keep them in cabinets or on shelves.
- Keep the system's CD cover closed when not in use.

Cleaning the lens

If the lens in the CD pickup is dirty, dropout, etc., could degrade sound.

Open the CD cover and clean the lens as shown.

- Use a blower (available from a camera store) to blow dust off the lens.

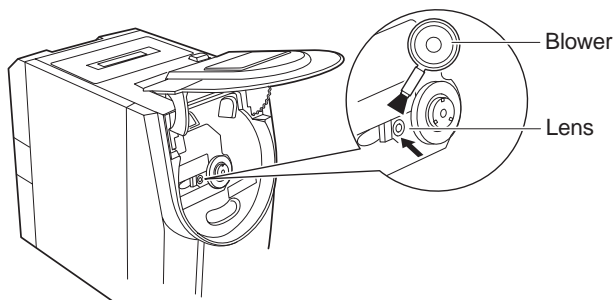

- If there are fingerprints, etc. on the lens, gently wipe clean with a cotton swab.

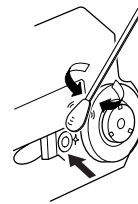

Moisture Condensation

Moisture may condense on the lens inside the System in the following cases:

- After turning on heating in the room.
- In a damp room.
- If the System is brought directly from a cold to a warm place.

Should this occur, the System may malfunction. In this case, leave the System turned on for a few hours until the moisture evaporates, unplug the AC power cord, and then plug it in again.



Cassette Tapes

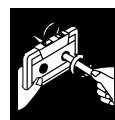

- If the tape is loose, it may get stretched, cut, or caught in the cassette. Take up the slack by inserting a pencil in one of the reels and rotating.



- Do not touch the tape surface.



- Do not store the tape:
 - In dusty places
 - In direct sunlight or heat
 - In moist areas
 - On a TV or speaker
 - Near a magnet

Cassette Deck

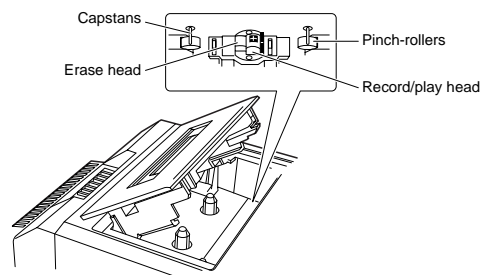

- If the heads, capstans, or pinch-rollers of the Cassette Deck become dirty, the following may occur:
 - Loss of sound quality
 - Discontinuous sound
 - Fading
 - Incomplete erasure
 - Difficulty recording
- Clean the heads, capstans, and pinch-rollers using a cotton swab moistened with alcohol.



- If the heads become magnetized, the Unit will produce noise or lose high frequency notes.
- To demagnetize the heads, turn off the Unit, and use a head demagnetizer (available at electronics and record shops).

Troubleshooting

- If you are having a problem with your System, check this list for a possible solution before calling for service.
- If you cannot solve the problem from the hints given here, or the System has been physically damaged, call a qualified person, such as your dealer, for service.

Symptom	Possible Cause	Action
No sound is heard.	<ul style="list-style-type: none"> • Connections are incorrect, or loose. • Headphones are connected. 	<ul style="list-style-type: none"> • Check all connections and make corrections. (See pages 4- 5.) • Disconnect the headphones.
Unable to record.	Cassette record protect tabs are removed.	Cover the holes on the back edge of the cassette with tape.
Poor radio reception	<ul style="list-style-type: none"> • The antenna is disconnected. • The AM Loop Antenna is too close to the System. • The FM Wire Antenna is not properly extended and positioned. 	<ul style="list-style-type: none"> • Reconnect the antenna securely. • Change the position and direction of the AM Loop Antenna. • Extend FM Wire Antenna to the best reception position.
The CD skips.	The CD is dirty or scratched.	Clean or replace the CD.
The CD does not play.	The CD is upside down.	Put the CD in with the label side up.
Unable to operate the Remote Control.	<ul style="list-style-type: none"> • The path between the Remote Control and the sensor on the Unit is blocked. • The batteries have lost their charge. 	<ul style="list-style-type: none"> • Remove the obstruction. • Replace the batteries.
Operations are disabled.	The built-in microprocessor has malfunctioned due to external electrical interference.	Unplug the System then plug it back in.
The cassette holder cannot be opened.	During tape playing, the power cord was unplugged.	Plug in the power cord, press the  button, and then press the  button.

Specifications

Amplifier

Output Power 34 W (17 W + 17 W) at 4 ohms (Max.)
24 W (12 W + 12 W) at 4 ohms (10% THD)

Input Sensitivity/Impedance (1 kHz)
LINE IN (AUX) 500 mV/65 kohms
Output Sensitivity/Impedance (1 kHz)
LINE OUT 500 mV/4.3 kohms
Optical out -21 dBm - -15 dBm
Speaker terminals 4 - 16 ohms
Phones 16 ohms - 1 kohms
0 - 15 mW/ch output into 32 ohms

Cassette Deck

Frequency Response
TypeII (CrO₂) 50 Hz - 15 kHz
Wow and Flutter 0.15 % (WRMS)

CD Player

Signal-To-Noise Ratio 90 dB
Wow And Flutter Unmeasurable

Tuner

FM Tuner
Tuning Range 87.5 - 108.0 MHz
AM Tuner
Tuning Range (MW) 522 - 1,629 kHz
(LW) 144 - 288 kHz

Speaker Specifications

(each unit) Speakers 8 cm cone
Impedance 4 ohms
Dimensions 140 × 230 × 217 mm (W/H/D)
Mass Approx. 1.8 kg

General

Dimensions 438 × 232 × 310.5 mm (W/H/D)
Mass Approx. 7.2 kg

Accessories

Power Cord (1)
AM Loop Antenna (1)
Remote Control (1)
Batteries R6P (SUM-3)/AA (15F) (2)
FM Wire Antenna (1)

Power Specifications

Power Requirements AC 230 V ~ , 50 Hz
Power Consumption 38 watts (power on mode)
3.5 watts (in Standby mode)

Design and specifications are subject to change without notice.



JVC
VICTOR COMPANY OF JAPAN, LIMITED