

JVC

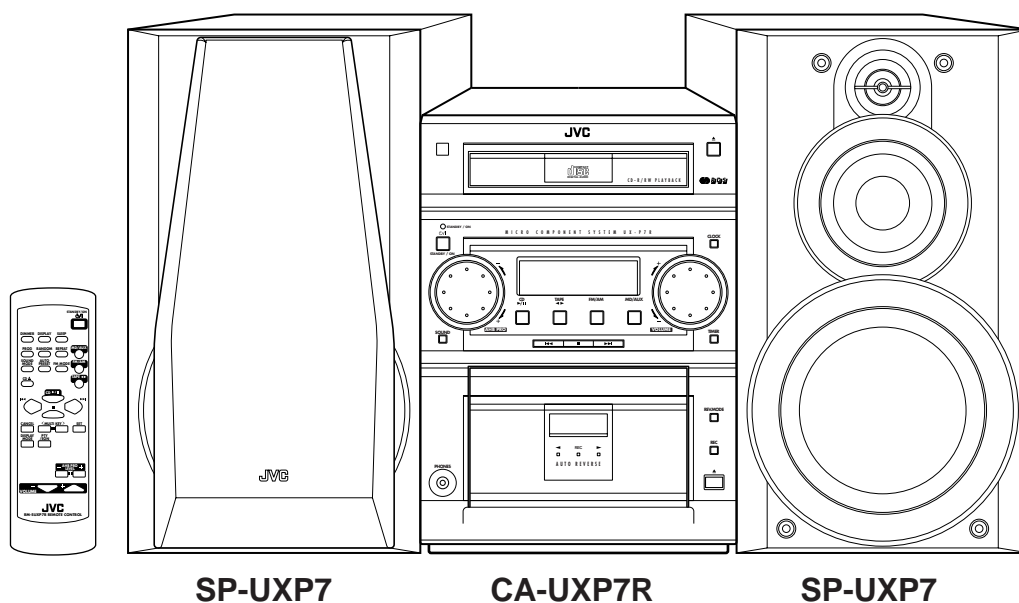

MICRO COMPONENT SYSTEM

UX-P7R — Consists of CA-UXP7R and SP-UXP7.



SP-UXP7

CA-UXP7R

SP-UXP7



INSTRUCTIONS

For Customer Use:

Enter below the Model No. and Serial No. which are located either on the rear, bottom or side of the cabinet. Retain this information for future reference.

Model No. _____

Serial No. _____

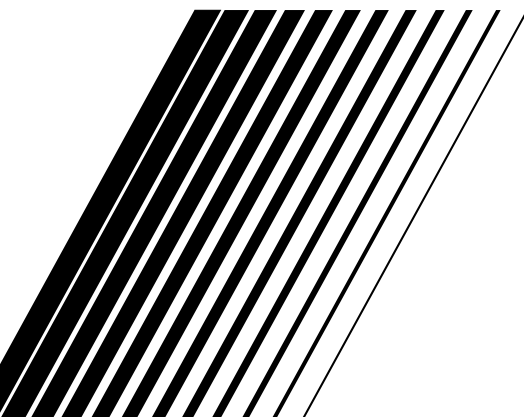

Warnings, Cautions and Others

IMPORTANT for the U.K.

DO NOT cut off the mains plug from this equipment. If the plug fitted is not suitable for the power points in your home or the cable is too short to reach a power point, then obtain an appropriate safety approved extension lead or consult your dealer.

BE SURE to replace the fuse only with an identical approved type, as originally fitted.

If nonetheless the mains plug is cut off ensure to remove the fuse and dispose of the plug immediately, to avoid a possible shock hazard by inadvertent connection to the mains supply.

If this product is not supplied fitted with a mains plug then follow the instructions given below:

IMPORTANT:

DO NOT make any connection to the terminal which is marked with the letter E or by the safety earth symbol or coloured green or green-and-yellow.

The wires in the mains lead on this product are coloured in accordance with the following code:

Blue : Neutral
Brown : Live

As these colours may not correspond with the coloured markings identifying the terminals in your plug proceed as follows:

The wire which is coloured blue must be connected to the terminal which is marked with the letter N or coloured black.

The wire which is coloured brown must be connected to the terminal which is marked with the letter L or coloured red.

IF IN DOUBT - CONSULT A COMPETENT ELECTRICIAN.

Caution — STANDBY/ON button!

Disconnect the mains plug to shut the power off completely (the STANDBY/ON lamp goes off). The  STANDBY/ON button in any position does not disconnect the mains line.

- When the unit is on standby, the STANDBY/ON lamp lights red.
- When the unit is turned on, the STANDBY/ON lamp lights green.

The power can be remote controlled.

IMPORTANT FOR LASER PRODUCTS

REPRODUCTION OF LABELS

- ① CLASSIFICATION LABEL, PLACED ON REAR ENCLOSURE

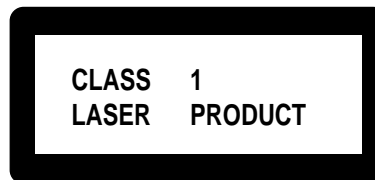

- ② WARNING LABEL, PLACED INSIDE THE UNIT

CAUTION: Invisible laser radiation when open and interlock failed or defeated. AVOID DIRECT EXPOSURE TO BEAM. (e)

ADVARSEL: Usynlig laserstråling ved åbning, når sikkerhedsafbrydere er ude af funktion. Undgå udsættelse for stråling (d)

WARNING: Osynlig laserstråling når denna del är öppnad och spärren är urkopplad. Beträkta ej strålen. (s)

VARO: Avattaessa ja suojalukitus ohitettaessa olet alltiina näkymättömälle lasersäteilylle. Älä katso säteeseen. (f)

1. CLASS 1 LASER PRODUCT
2. **CAUTION:** Invisible laser radiation when open and interlock failed or defeated. Avoid direct exposure to beam.
3. **CAUTION:** Do not open the top cover. There are no user serviceable parts inside the Unit; leave all servicing to qualified service personnel.

CAUTION

To reduce the risk of electrical shocks, fire, etc.:

1. Do not remove screws, covers or cabinet.
2. Do not expose this appliance to rain or moisture.

CAUTION

- Do not block the ventilation openings or holes. (If the ventilation openings or holes are blocked by a newspaper or cloth, etc., the heat may not be able to get out.)
- Do not place any naked flame sources, such as lighted candles, on the apparatus.
- When discarding batteries, environmental problems must be considered and local rules or laws governing the disposal of these batteries must be followed strictly.
- Do not use this apparatus in a bathroom or places with water. Also do not place any containers filled with water or liquids (such as cosmetics or medicines, flower vases, potted plants, cups, etc.) on top of this apparatus.

Caution: Proper Ventilation

To avoid risk of electric shock and fire, and to prevent damage, locate the apparatus as follows:

1 Front:

No obstructions and open spacing.

2 Sides/ Top/ Back:

No obstructions should be placed in the areas shown by the dimensions below.

3 Bottom:

Place on the level surface. Maintain an adequate air path for ventilation by placing on a stand with a height of 10 cm (3 15/16 in) or more.

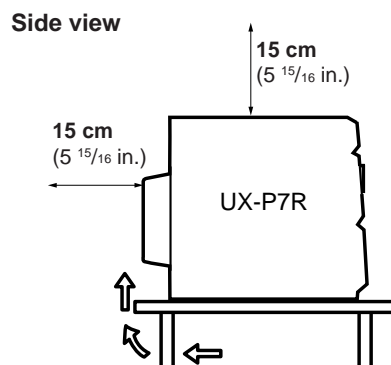
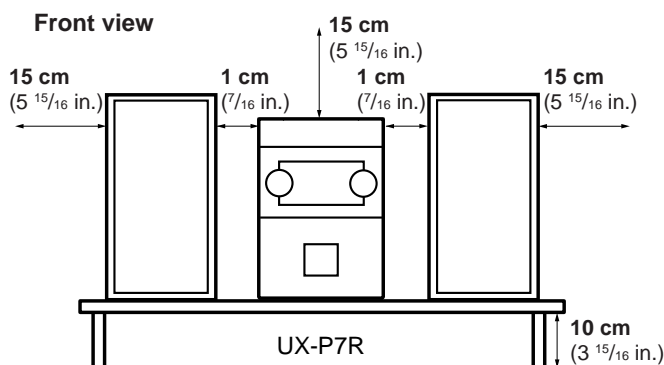

SAFETY INSTRUCTIONS

“SOME DOS AND DON'TS ON THE SAFE USE OF EQUIPMENT”

This equipment has been designed and manufactured to meet international safety standards but, like any electrical equipment, care must be taken if you are to obtain the best results and safety is to be assured.

Do read the operating instructions before you attempt to use the equipment.

Do ensure that all electrical connections (including the mains plug, extension leads and interconnections between pieces of equipment) are properly made and in accordance with the manufacturer's instructions. Switch off and withdraw the mains plug when making or changing connections.

Do consult your dealer if you are ever in doubt about the installation, operation or safety of your equipment.

Do be careful with glass panels or doors on equipment.

DON'T continue to operate the equipment if you are in any doubt about it working normally, or if it is damaged in any way – switch off, withdraw the mains plug and consult your dealer.

DON'T remove any fixed cover as this may expose dangerous voltages.

DON'T leave equipment switched on when it is unattended unless it is specifically stated that it is designed for unattended operation or has a standby mode.

Switch off using the switch on the equipment and make sure that your family know how to do this.

Special arrangements may need to be made for infirm or handicapped people.

DON'T use equipment such as personal stereos or radios so that you are distracted from the requirements of traffic safety. It is illegal to watch television whilst driving.

DON'T listen to headphones at high volume as such use can permanently damage your hearing.

DON'T obstruct the ventilation of the equipment, for example with curtains or soft furnishings.

Overheating will cause damage and shorten the life of the equipment.

DON'T use makeshift stands and NEVER fix legs with wood screws — to ensure complete safety always fit the manufacturer's approved stand or legs with the fixings provided according to the instructions.

DON'T allow electrical equipment to be exposed to rain or moisture.

ABOVE ALL

- NEVER let anyone, especially children, push anything into holes, slots or any other opening in the case — this could result in a fatal electrical shock.
- NEVER guess or take chances with electrical equipment of any kind — it is better to be safe than sorry!

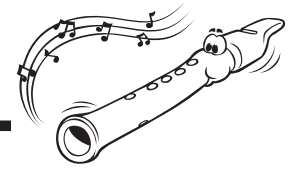

Introduction

We would like to thank you for purchasing one of our JVC products. Before operating this unit, read this manual carefully and thoroughly to obtain the best possible performance from your unit, and retain this manual for future reference.

About This Manual

This manual is organized as follows:

- The manual mainly explains operations using the buttons on the remote control. You can use the buttons both on the remote control and on the unit for the same operations if they have the same or similar names (or marks), unless mentioned otherwise.
- Basic and common information that is the same for many functions is grouped in one place, and is not repeated in each procedure. For instance, we do not repeat the information about turning on/off the unit, setting the volume, changing the sound effects, and others, which are explained in the section “Common Operations” on pages 9 and 10.
- The following marks are used in this manual:



Gives you warnings and cautions to prevent from damage or risk of fire/electric shock. Also gives you information which is not good for obtaining the best possible performance from the unit.



Gives you information and hints you had better know.

Precautions

Installation

- Install in a place which is level, dry and neither too hot nor too cold — between 5°C (41°F) and 35°C (95°F).
- Install the unit in a location with adequate ventilation to prevent internal heat built-up in the unit.
- Leave sufficient distance between the unit and the TV.
- Keep the speakers away from the TV to avoid interference with TV.



DO NOT install the unit in a location near heat sources, or in a place subject to direct sunlight, excessive dust or vibration.

Power sources

- When unplugging from the wall outlet, always pull the plug, not the AC power cord.



DO NOT handle the AC power cord with wet hands.

Moisture condensation

Moisture may condense on the lens inside the unit in the following cases:

- After starting heating in the room
 - In a damp room
 - If the unit is brought directly from a cold to a warm place
- Should this occur, the unit may malfunction. In this case, leave the unit turned on for a few hours until the moisture evaporates, unplug the AC power cord, and then plug it in again.

Others

- Should any metallic object or liquid fall into the unit, unplug the unit and consult your dealer before operating any further.
- If you are not going to operate the unit for an extended period of time, unplug the AC power cord from the wall outlet.



DO NOT disassemble the unit since there are no user serviceable parts inside.

If anything goes wrong, unplug the AC power cord and consult your dealer.

Contents

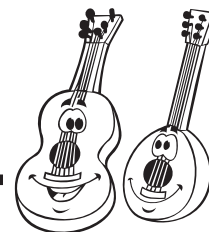

Location of the Buttons and Controls	3	Playing Back CDs (CD/CD-R/CD-RW)	14
Front Panel	3	Playing Back the Entire CD — Normal Play	14
Remote Control	5	Basic CD Operations	14
Getting Started	6	Programming the Playing Order of the Tracks	
Supplied Accessories	6	— Program Play	15
Putting the Batteries into the Remote Control	6	Playing at Random — Random Play	16
Connecting Antennas	6	Repeating Tracks — Repeat Play	16
Connecting Speakers	7	Prohibiting Disc Ejection — Tray Lock	16
Connecting Other Equipment	8	Playing Back Tapes	17
Common Operations	9	Playing Back a Tape	17
Turning On the Power	9	Recording	18
Setting the Clock	9	Recording on a Tape	18
Selecting the Sources and Starting Play	9	CD Direct Recording	19
Adjusting the Volume	10	One Track Recording	19
Selecting the Display Brightness	10	Using the Timers	20
Reinforcing the Bass Sound	10	Using Daily Timer and Recording Timer	20
Selecting the Sound Modes	10	Using Sleep Timer	21
Listening to FM and AM (MW/LW) Broadcasts ...	11	Additional Information	22
Tuning in a Station	11	Troubleshooting	22
Presetting Stations	11	Maintenance	23
Tuning in a Preset Station	11	Specifications	24
Receiving FM Stations with RDS	12		
Changing the RDS Information	12		
Searching for Programs by PTY Codes			
(PTY Search)	12		
Switching to a Program Type of Your			
Choice Temporarily	13		

Location of the Buttons and Controls

Become familiar with the buttons and controls on your unit.

Front Panel

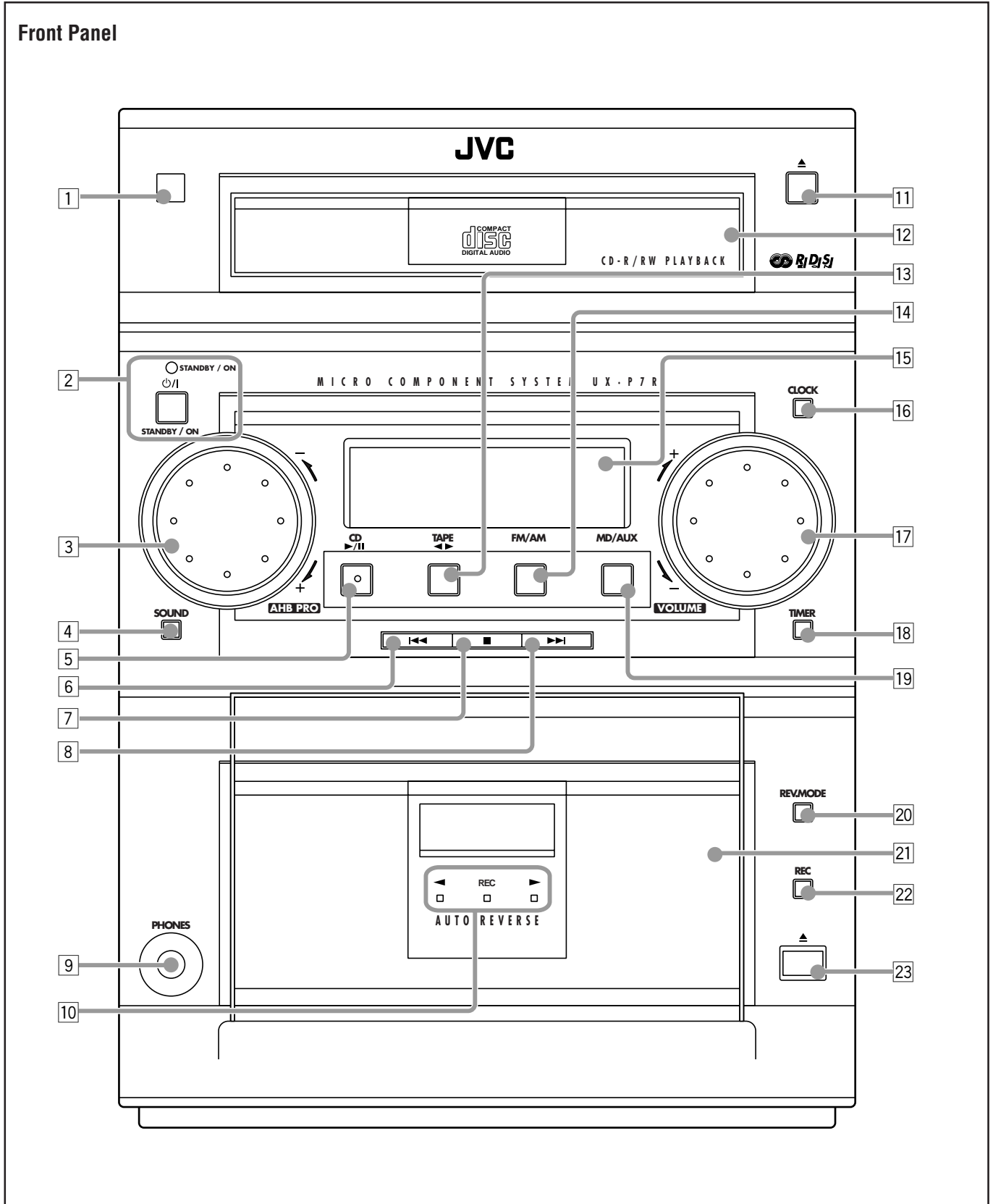



Display Window

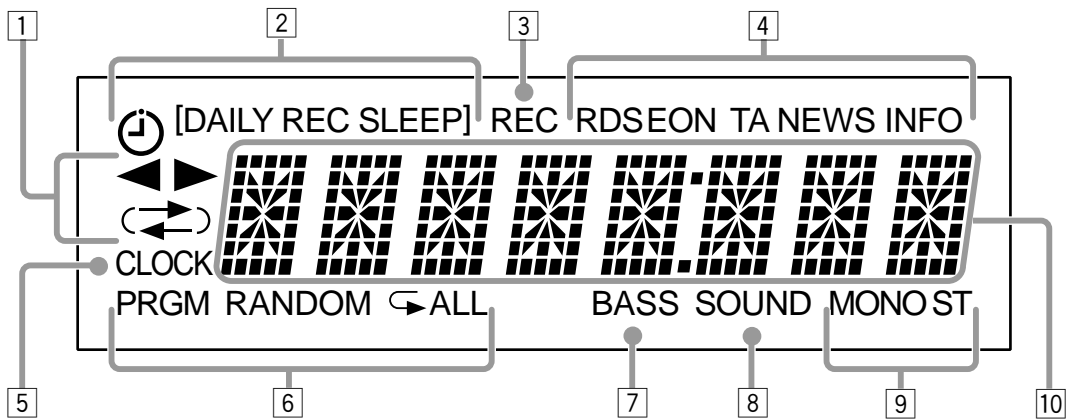

See pages in the parentheses for details.

Front Panel

- 1 Remote sensor
- 2 \odot/I (STANDBY/ON) button and STANDBY/ON lamp (9, 16, 21)
- 3 AHB (Active Hyper Bass) PRO + / - control (10)
- 4 SOUND button (10)
- 5 CD $\blacktriangleright/\text{II}$ (play/pause) button (9, 14, 19)
Pressing this button also turns on the unit.
- 6 $\blacktriangleleft\blacktriangleleft$ (reverse search) button (9, 11, 14, 17, 20)
- 7 \blacksquare (stop) button (14 – 19)
- 8 $\blacktriangleright\blacktriangleright$ (forward search) button (9, 11, 14, 16, 17, 20)
- 9 PHONES jack (10)
- 10 Tape operation lamps (17, 18)
 - $\blacktriangleleft\blacktriangleright$ (tape direction) and REC lamps
- 11 \blacktriangle (disc tray open/close) button (14)
Pressing this button also turns on the unit.
- 12 Disc tray
- 13 TAPE $\blacktriangleleft\blacktriangleright$ button (9, 17, 18)
Pressing this button also turns on the unit.
- 14 FM/AM button (9, 11)
Pressing this button also turns on the unit.
- 15 Display window
- 16 CLOCK button (9)
- 17 VOLUME + / - control (10)
- 18 TIMER button (20, 21)
- 19 MD/AUX button (9)
Pressing this button also turns on the unit.
- 20 REV.MODE (reverse mode) button (17 – 19)
- 21 Cassette holder
- 22 REC button (18, 19)
- 23 \blacktriangle (eject) button for cassette deck (17 – 19)

Display Window

- 1 Tape operation indicators
 - $\blacktriangleleft\blacktriangleright$ (tape direction) and $\blacktriangleleft\blacktriangleright$ (reverse mode) indicators
- 2 Timer indicators
 - \odot (timer), DAILY, REC and SLEEP indicators
- 3 REC indicator
- 4 RDS operation indicators
 - RDS, EON, and TA/NEWS/INFO indicators
- 5 CLOCK indicator
- 6 CD play mode indicators
 - PRGM (program), RANDOM, and repeat ($\blacktriangleleft/\blacktriangleright$ ALL) indicators
- 7 BASS (Active Hyper Bass) indicator
- 8 SOUND (sound mode) indicator
- 9 Tuner operation indicators
 - MONO and ST (stereo) indicators
- 10 Main display
 - Shows the source name, frequency, etc.



Remote Control

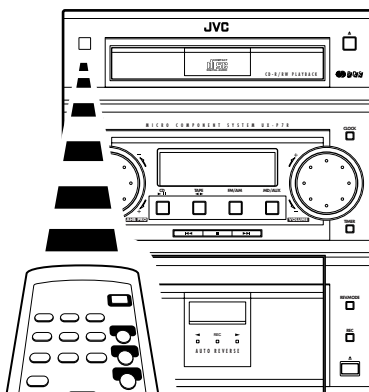
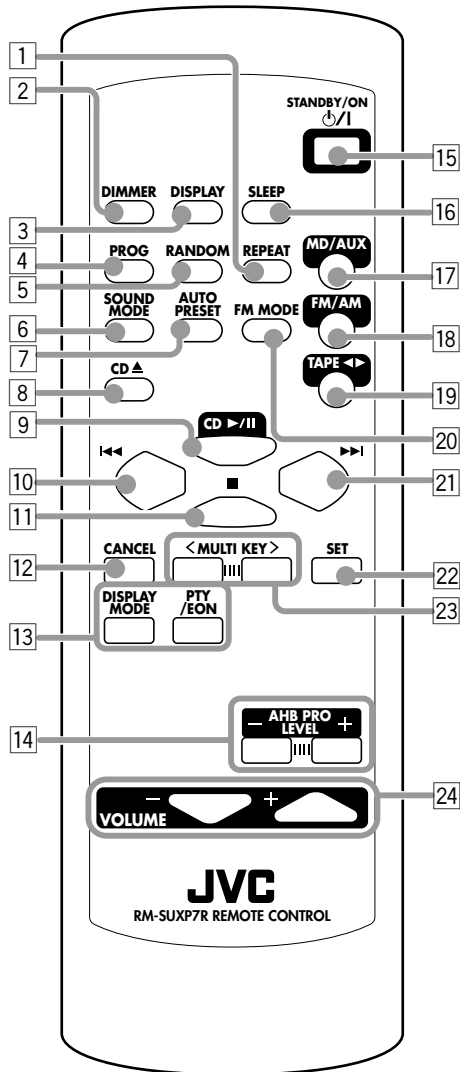

When using the remote control, point it at the remote sensor on the front panel.

Remote Control

- 1 REPEAT button (16)
- 2 DIMMER button (10)
- 3 DISPLAY button (9)
- 4 PROG (program) button (15)
- 5 RANDOM button (16)
- 6 SOUND MODE button (10)
- 7 AUTO PRESET button (11)
- 8 CD ▲ (disc tray open/close) button (14)
Pressing this button also turns on the unit.
- 9 CD ►/|| button (9, 14, 15)
Pressing this button also turns on the unit.
- 10 ◀◀ (reverse search) button (11 – 14, 17)
- 11 ■ (stop) button (14 – 19)
- 12 CANCEL button (15)
- 13 RDS operation buttons (12, 13)
 - DISPLAY MODE and PTY/EON buttons
- 14 AHB (Active Hyper Bass) PRO LEVEL + / – buttons (10)
- 15 ⏻ (STANDBY/ON) button (9)
- 16 SLEEP button (21)
- 17 MD/AUX button (9)
Pressing this button also turns on the unit.
- 18 FM/AM button (9, 11)
Pressing this button also turns on the unit.
- 19 TAPE ◀▶ button (9, 17)
Pressing this button also turns on the unit.
- 20 FM MODE button (11)
- 21 ▶▶ (forward search) button (11 – 14, 16, 17)
- 22 SET button (11, 15)
- 23 MULTI KEY > / < buttons (11, 14 – 16)
- 24 VOLUME + / – buttons (10)

Supplied Accessories

Make sure that you have all the following items. The number in the parentheses indicates the quantity of the pieces supplied.

- AM loop antenna (1)
- FM antenna (1)
- Remote control (1)
- Batteries (2)
- Speaker cords (2 sets)

If anything is missing, consult your dealer immediately.

Putting the Batteries into the Remote Control

Insert the batteries — R6(SUM-3)/AA(15F) — into the remote control, by matching the polarity (+ and –) on the batteries with the + and – markings on the battery compartment.

When the remote control can no longer operate the unit, replace both batteries at the same time.

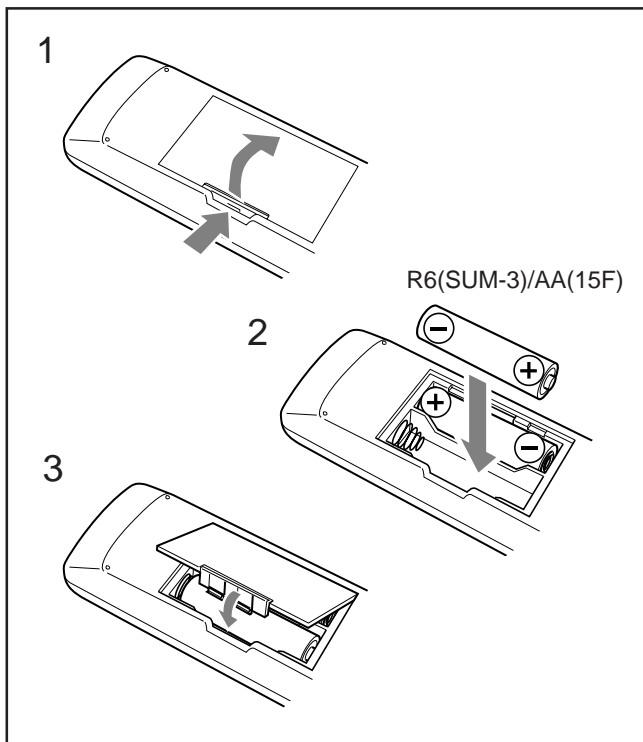

- DO NOT use an old battery together with a new one.
- DO NOT use different types of batteries together.
- DO NOT expose batteries to heat or flame.
- DO NOT leave the batteries in the battery compartment when you are not going to use the remote control for an extended period of time. Otherwise, it will be damaged from battery leakage.

Connecting Antennas

FM antenna

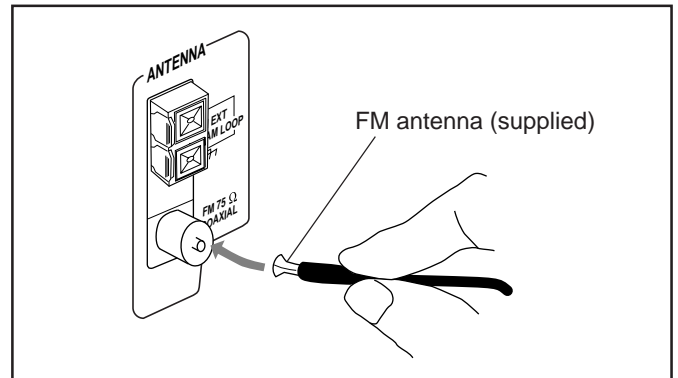

- 1 Attach the FM antenna to the FM 75 Ω COAXIAL terminal.
- 2 Extend the FM antenna.
- 3 Fasten it up in the position which gives you the best reception, then fix it on the wall, etc.



About the supplied FM antenna

The FM antenna supplied with this unit can be used as temporary measure. If reception is poor, you can connect an outdoor FM antenna.

To connect an outdoor FM antenna

Before connecting it, disconnect the supplied FM antenna.

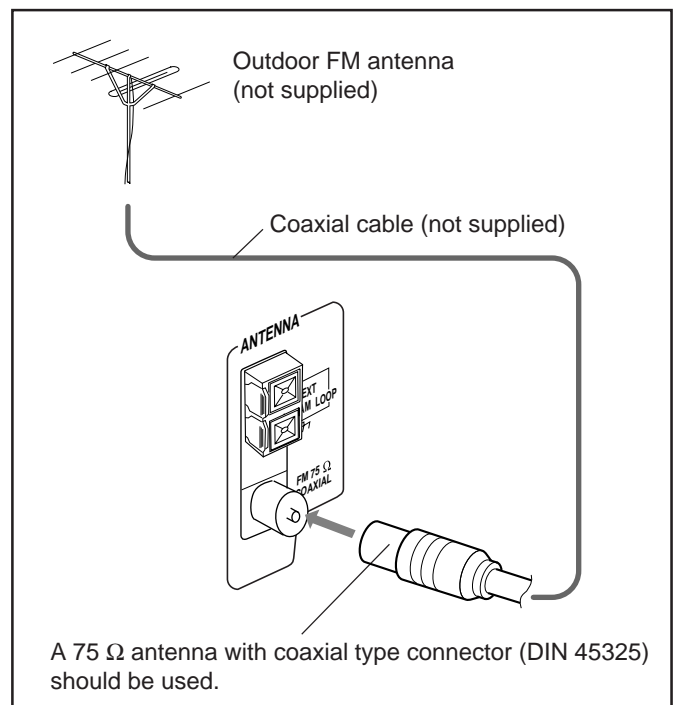

AM (MW/LW) antenna

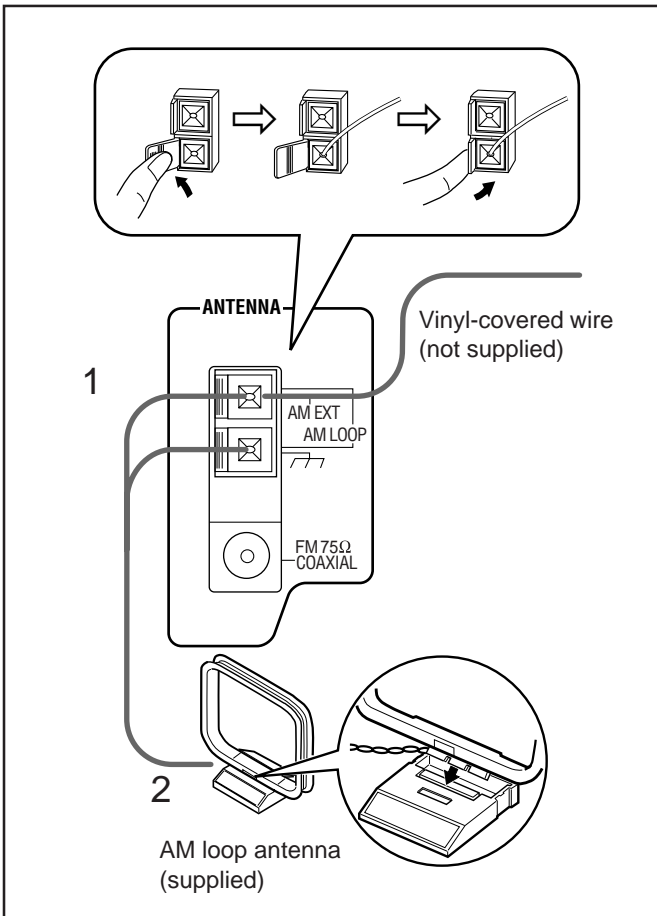

1 Connect the AM loop antenna to the AM LOOP terminals as illustrated.

- If the AM loop antenna wire is covered with vinyl, remove the vinyl by twisting it as shown in the diagram.

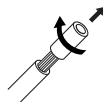

2 Turn the AM loop antenna until you have the best reception.

To connect an outdoor AM (MW/LW) antenna

When reception is poor, connect a single vinyl-covered wire to the AM EXT terminal and extend it horizontally. (The AM loop antenna must remain connected.)



For better reception of both FM and AM (MW/LW)

- Make sure the antenna conductors do not touch any other terminals and connecting cords.
- Keep the antennas away from metallic parts of the unit, connecting cords, and the AC power cord.

Connecting Speakers

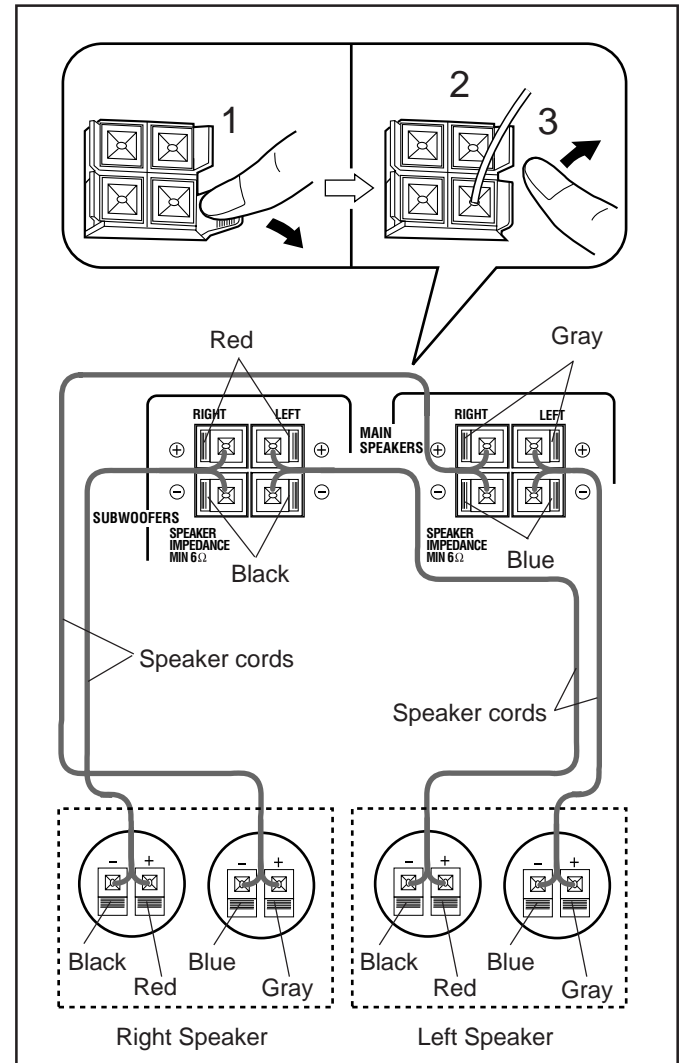

1 Press and hold the clamp of the speaker terminal on the rear of the unit.

2 Insert the end of the speaker cord into the terminal.

Match the polarity of the speaker terminals: Red (+) to red (+), black (-) to black (-); Gray (+) to gray (+) and blue (-) to blue (-).

- Remove the vinyl covering the wire by twisting it as shown in the diagram.

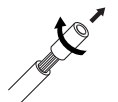

3 Release the finger from the clamp.

IMPORTANT: Use only speakers with the same speaker impedance as indicated by the speaker terminals on the rear of the unit.



To remove the speaker grilles

The speaker grilles are removed as the illustrations below.

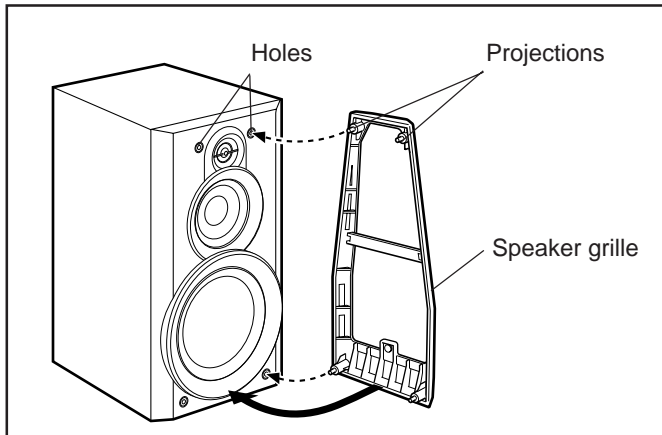

To remove the speaker grille, inserting your fingers at the top of the speaker grille, pull towards you. Then pull the bottom towards you.

To attach the speaker grille, put the projections of the speaker grille into the holes of the speaker.

Connecting Other Equipment

You can connect both of the analog and digital equipment.



- DO NOT connect any equipment while the power is on.
- DO NOT plug in any equipment until all connections are complete.

To connect audio equipment

Be sure that the plugs of the audio cords are colored: White plugs and jacks are for left audio signals, and red ones for right audio signals.

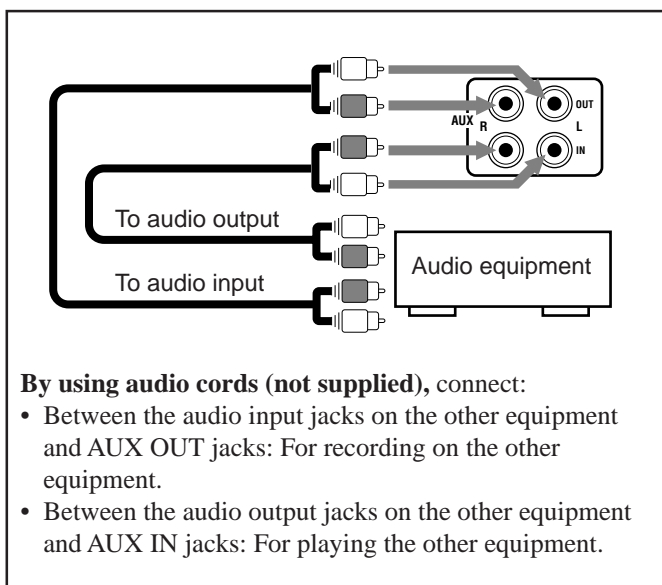

By using audio cords (not supplied), connect:

- Between the audio input jacks on the other equipment and AUX OUT jacks: For recording on the other equipment.
- Between the audio output jacks on the other equipment and AUX IN jacks: For playing the other equipment.

To connect audio equipment with an optical digital input terminal

You can record CD sound onto the connected digital equipment.

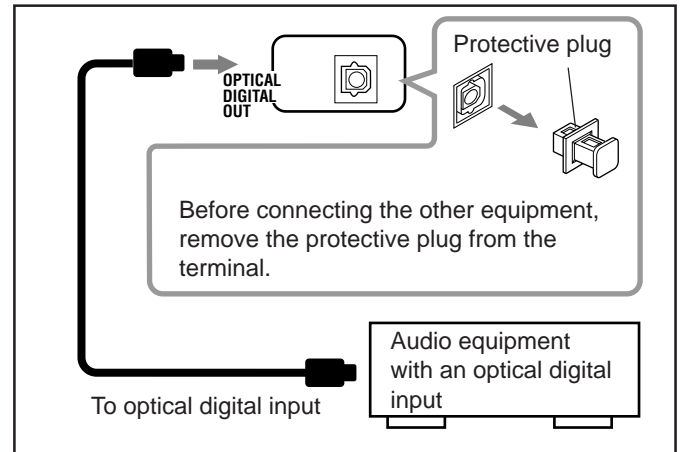

Connect an optical digital cord (not supplied) between the optical digital input terminal on the other equipment and the OPTICAL DIGITAL OUT terminal.

Now, you can plug the AC power cord.

IMPORTANT: Be sure to check all connections to be done before plugging the AC power cord into a wall outlet.

Common Operations

Turning On the Power

When you press the play button — CD ►/II, TAPE ◀▶, or the source selecting button — FM/AM, and MD/AUX, the unit automatically turns on and starts playback if the source is ready.

To turn on the unit, press  (STANDBY/ON). The STANDBY/ON lamp lights green.

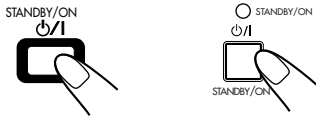

To turn off the unit (on standby), press  (STANDBY/ON) again.

The STANDBY/ON lamp lights red.

- The CLOCK indicator flashes on the display until you set the built-in clock. After setting the clock, the clock time will appear on the display while the power is off.
- A little power is always consumed even while the unit is on standby.

To switch off the power supply completely, unplug the AC power cord from the AC outlet.

 When you unplug the AC power cord or if a power failure occurs

The clock is reset to “0:00” right away, while the tuner preset stations (see page 11) will be erased in a few days.

Setting the Clock

Before operating the unit any further, first set the clock built in this unit. When you plug the AC power cord into the wall outlet, the CLOCK indicator starts flashing on the display. You can set the clock whether the unit is on or off.

- There is a time limit in doing the following steps. If the setting is canceled before you finish, start from step 1 again.

On the unit ONLY:

1 Press **CLOCK** for more than 2 seconds.

The hour digits start flashing on the display.



2 Press ►► or ◀◀ to adjust the hour, then press **CLOCK**.

The minute digits start flashing on the display.

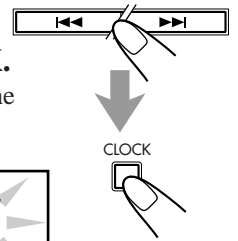

3 Press ►► or ◀◀ to adjust the minute, then press **CLOCK**.

The CLOCK indicator remains lit on the display.

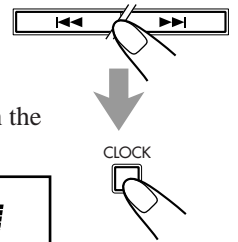

To check the clock time

Press DISPLAY on the remote control (or CLOCK on the unit) while playing any source.

- Each time you press the button, the source indication and the clock time alternate on the display.

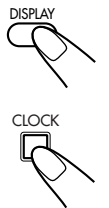

- When you unplug the AC power cord or if a power failure occurs, the clock loses the setting and is reset to “0:00.” You need to set the clock again.
- The clock may gain or lose 1 to 2 minutes per month.

Selecting the Sources and Starting Play

To play back CDs, press CD ►/II. (See pages 14 – 16.)

To play back tapes, press TAPE ◀▶. (See page 17.)

To listen to the FM/AM (MW/LW) broadcasts, press FM/AM. (See pages 11 – 13.)

To select the external equipment as the source, press MD/AUX.



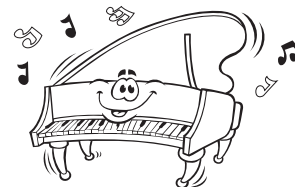

Adjusting the Volume

You can adjust the volume level only while the unit is turned on. The volume level can be adjusted between “VOLUME 0” and “VOLUME40.”

When using the remote control, press VOLUME + to increase the volume or press VOLUME – to decrease it.



When using the unit, turn VOLUME + / – clockwise (+) to increase the volume or counterclockwise (–) to decrease it.

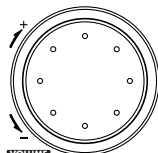

VOLUME 15



For private listening

Connect a pair of headphones to the PHONES jack. No sound comes out of the speakers. Be sure to turn down the volume before connecting or putting on headphones.



DO NOT turn off (on standby) the unit with the volume set to an extremely high level; otherwise, a sudden blast of sound can damage your hearing, speakers and/or headphones when you turn on the unit or start playing any source next time. REMEMBER you cannot adjust the volume level while the unit is on standby.

Selecting the Display Brightness

You can change the display brightness only while the unit is turned on.

To change the display brightness, press DIMMER on the remote control.

- Each time you press the button, the display dims and brightens alternately.



Reinforcing the Bass Sound

You can reinforce the bass sound to maintain rich, full bass at low volume. This function only affects the playback sound, but does not affect your recording.

When using the remote control, press AHB PRO LEVEL + to increase the bass sound or press AHB PRO LEVEL – to decrease it.



When using the unit, turn AHB PRO + / – clockwise (+) to increase the bass sound or counterclockwise (–) to decrease it.

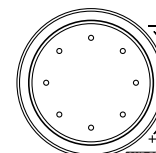

- The bass sound level can be adjusted in 5 steps (“BASS 1” to “BASS 5”). The BASS indicator also lights up on the display.

To cancel the effect, press AHB PRO LEVEL – on the remote control (or turn AHB PRO + / – counterclockwise on the unit) until “BASS 0” appears on the display. The BASS indicator goes off.

Selecting the Sound Modes

You can select one of the 4 preset sound modes. This function only affects the playback sound, but does not affect your recording.

To select the sound modes, press SOUND MODE on the remote control (or SOUND on the unit) until the sound mode you want appears on the display. The SOUND indicator also lights up on the display.



- Each time you press the button, the sound modes change as follows:

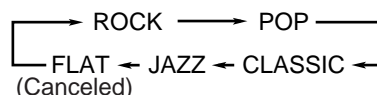

ROCK: Gives a heavy sound. Boosts low and high frequency.

POP: Good for vocal music.

CLASSIC: Good for classical music.

JAZZ: Gives a feeling of live atmosphere. Good for acoustic music.

FLAT: The sound mode is canceled. The SOUND indicator goes off.

Listening to FM and AM (MW/LW) Broadcasts



Tuning in a Station

1 Press FM/AM.

The unit automatically turns on and tunes in the previously tuned station (either FM or AM — MW/LW).

- Each time you press the button, the band alternates between FM and AM (MW/LW).



2 Press and hold ►►► or ◄◄◄ for more than 1 second.

The unit starts searching for stations and stops when a station of sufficient signal strength is tuned in.

If a program is broadcast in stereo, the ST (stereo) indicator lights up.

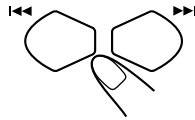

To stop searching, press ►►► or ◄◄◄.



When you press ►►► or ◄◄◄ briefly and repeatedly the frequency changes step by step.

To change the FM reception mode

When an FM stereo broadcast is hard to receive or noisy, press FM MODE on the remote control so that the MONO indicator lights up on the display. Reception improves.



To restore the stereo effect, press FM MODE again so that the MONO indicator goes off. In this stereo mode, you can hear stereo sounds when a program is broadcast.

Presetting Stations

You can preset 30 FM and 15 AM (MW/LW) stations — using either automatic presetting or manual presetting. In some cases, test frequencies have been already memorized for the tuner since the factory examined the tuner preset function before shipment. This is not a malfunction. You can preset the stations you want into memory by following the presetting method.

To preset stations automatically — Automatic Presetting

You need to preset stations separately for the FM and AM (MW/LW) bands.

On the remote control ONLY:

1 Press FM/AM to select the band.

- Each time you press the button, the band alternates between FM and AM (MW/LW).



2 Press and hold AUTO PRESET for more than 2 seconds.

Local stations with strong signals are searched and stored in memory automatically.

When automatic presetting is over, the station stored in preset number 1 is received.



3 Repeat steps 1 and 2 to store stations for the other band.



When you cannot automatically store stations you want Stations with weak signals cannot be detected with this automatic presetting. To store such a station, use the manual presetting.

To preset stations manually — Manual Presetting

- There is a time limit in doing the following steps. If the setting is canceled before you finish, start from step 2 again.

On the remote control ONLY:

1 Tune in the station you want to preset.

- See “Tuning in a Station.”

2 Press SET.

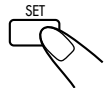

3 Press MULTI KEY > or MULTI KEY < to select a preset number.

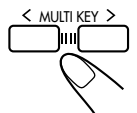
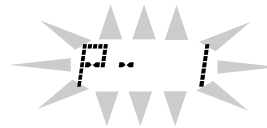

4 Press SET again.

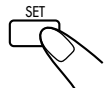

The tuned station in step 1 is stored in the preset number selected in step 3.

- Storing a new station on a used number erases the previously stored one.



When you unplug the AC power cord or if a power failure occurs

The preset stations will be erased in a few days. If this happens, preset the stations again.

Tuning in a Preset Station

On the remote control ONLY:

1 Press FM/AM.

The unit automatically turns on and tunes in the previously tuned station (either FM or AM — MW/LW).

- Each time you press the button, the band alternates between FM and AM (MW/LW).



2 Press MULTI KEY > or MULTI KEY < to select a preset number.

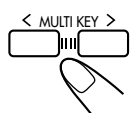

RDS (Radio Data System) allows FM stations to send an additional signal along with their regular program signals. For example, the stations send their station names, as well as information about what type of program they broadcast, such as sports or music, etc.

When tuned to an FM station which provides the RDS service, the RDS indicator lights up on the display. With the unit, you can receive the following types of RDS signals.

PS (Program Service):
Shows commonly known station names.

PTY (Program Type):
Shows types of broadcast programs.

RT (Radio Text):
Shows text messages the station sends.

EON (Enhanced Other Networks):
Provides the information about the types of the programs sent by other RDS stations.



More about RDS

- Some FM stations do not provide RDS signals.
- RDS services vary among FM RDS stations. For details on RDS services in your area, check with local radio stations.
- RDS may not work correctly if the received station is not transmitting the signals properly or if the signal strength is weak.

Changing the RDS Information

You can see RDS information on the display while listening to an FM station.

On the remote control ONLY:

Press DISPLAY MODE.

- Each time you press the button, the display changes to show the following information:

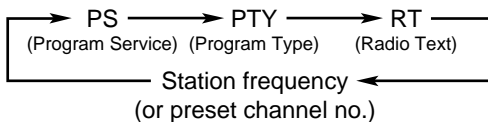
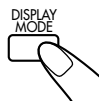

- **If no PS, PTY, or RT signals are sent by a station**
“NO PS,” “NO PTY,” or “NO RT” appears on the display.
- **On the characters displayed**
When the display shows PS, PTY or RT signals:
 - The display shows upper case letters only.
 - The display cannot show accented letters; For example, “A” may represent accented “A’s” like “Á, Â, Ã, Ä, Å and Ä.”

Searching for Programs by PTY Codes (PTY Search)

One of the advantages of RDS is that you can locate a particular kind of program by specifying the PTY codes.

- For details on the PTY codes, see “Additional Information” on page 22.

To search for a program using the PTY codes

REMEMBER you must preset FM RDS stations to use the PTY codes. If not yet done, see page 11.

- There is a time limit in doing the following steps. If the setting is canceled before you finish, start from step 1 again.

On the remote control ONLY:

1 Press PTY/EON until “PTY” and “SELECT” alternately appear on the display.



- Each time you press the button, RDS operation mode changes as follows:

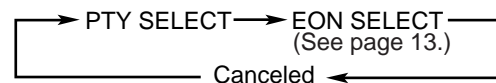

2 Press >>> or <<< until the PTY code you want appears on the display.

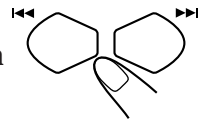

- Each time you press the button, the PTY codes change as follows:

NEWS ⇄ AFFAIRS ⇄ INFO ⇄ SPORT ⇄
 EDUCATE ⇄ DRAMA ⇄ CULTURE ⇄
 SCIENCE ⇄ VARIED ⇄ POP M ⇄ ROCK M ⇄
 EASY M ⇄ LIGHT M ⇄ CLASSICS ⇄
 OTHER M ⇄ WEATHER ⇄ FINANCE ⇄
 CHILDREN ⇄ SOCIAL ⇄ RELIGION ⇄
 PHONE IN ⇄ TRAVEL ⇄ LEISURE ⇄ JAZZ ⇄
 COUNTRY ⇄ NATION M ⇄ OLDIES ⇄
 FOLK M ⇄ DOCUMENT ⇄ TRAFFIC ⇄
 (back to the beginning)

3 Press PTY/EON once again.

While searching, “SEARCH” and the selected PTY code alternately appear on the display.

The unit searches 30 preset FM stations, stops when it finds the one you have selected (“FOUND” appears), and tunes in that station.

- If no program is found, “NOTFOUND” appears on the display and the unit returns to the last received station.



To stop searching any time during the process
Press PTY/EON while searching.

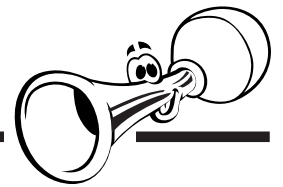

Switching to a Program Type of Your Choice Temporarily

By receiving EON (Enhanced Other Networks) data sent by FM RDS stations, the EON function allows the unit to switch temporarily to a broadcast program of your choice (TA, NEWS, and INFO) from a different station.

- The EON function only works when you are listening to a preset FM RDS stations providing EON data.
- The EON indicator lights while receiving a station with the EON data.

To activate the EON function

REMEMBER you must preset FM RDS stations to use the EON function. If not yet done, see page 11.

- There is a time limit in doing the following steps. If the setting is canceled before you finish, start from step 1 again.

On the remote control ONLY:

1 Press **PTY/EON** until “EON” and “SELECT” alternately appear on the display.

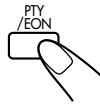

- Each time you press the button, RDS operation mode changes as follows:

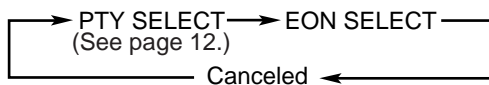

2 Press **▶▶▶** or **◀◀◀** until the EON data type you want appears on the display.

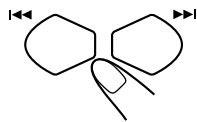

The selected EON data type indicator also flashes.



- Each time you press the button, the EON data types change as follows:

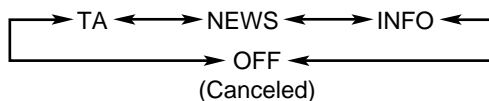

TA: Traffic announcement

NEWS: News

INFO: Program the purpose of which is to impart advice in the widest sense.

OFF: The EON function is canceled. The EON data type indicator (TA, NEWS, INFO) goes off.

3 Press **PTY/EON** once again.

The EON data type indicator stops flashing and remains lit.

Now, the EON function is activated. See “How the EON function actually works.”



How the EON function actually works:

CASE 1

If there is no station broadcasting the program you have selected

The unit continues tuning in the current station.



When a station starts broadcasting the program you have selected, the unit automatically switches to the station. The indicator of received PTY code starts flashing.



When the program is over, “EON END” appears on the display, and the unit goes back to the previously tuned station, but the EON function still remains activated.

CASE 2

If there is a station broadcasting the program you have selected

The unit tunes in the program. The indicator of received PTY code starts flashing.



When the program is over, “EON END” appears on the display, and the unit goes back to the previously tuned station, but the EON function still remains activated.

CASE 3

If the FM station you are listening to is broadcasting the program you have selected

The unit continues to receive the station but the indicator of received PTY code starts flashing.



When the program is over, “EON END” appears on the display, and the indicator of received PTY code stops flashing and remains lit, but the EON function still remains activated.



More about the EON function

- The EON data sent from some stations may not be compatible with this unit. In this case, the EON function may not work correctly.
- While listening to a program tuned in by the EON function, the station does not change even if another network station starts broadcasting a program of the same EON data.
- The EON function is canceled when you change the source to CD, TAPE, or MD/AUX, while it is temporarily canceled when you change the source to AM (MW/LW).

Playing Back CDs (CD/CD-R/CD-RW)

Continued 

This unit has been designed to playback the following CDs:

- CD
- CD-R
- CD-RW

Continued use of irregular shape CDs (heart-shape, octagonal, etc.) can damage the unit.

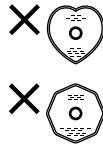

General Notes

In general, you will have the best performance by keeping your CDs and the mechanism clean.

- Store CDs in their cases, and keep them in cabinets or on shelves.
- Keep the unit's disc tray closed when not in use.

When playing a CD-R or CD-RW

User-edited CD-Rs (CD-Recordable) and CD-RWs (CD-ReWritable) can be played back only if they are already "finalized."

- You can play back your original CD-Rs or CD-RWs recorded in music CD format. (However, they may not be played back depending on their characteristics or recording conditions.)
- Before playing back CD-Rs or CD-RWs, read their instructions or cautions carefully.
- Some CD-Rs or CD-RWs may not be played back on this unit because of their disc characteristics, damage or stain on them, or if the player's lens is dirty.
- CD-RWs may require a longer readout time. (This is caused by the fact that the reflectance of CD-RWs is lower than for regular CDs.)

Playing Back the Entire CD — Normal Play

1 Press CD on the remote control (or on the CD player section).

The unit automatically turns on and the disc tray comes out.

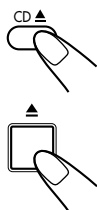

2 Place a disc correctly on the circle of the disc tray, with its label side up.

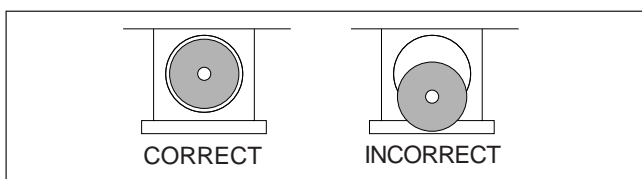

- When using a CD single (8 cm), place it on the inner circle of the disc tray.

3 Press CD on the remote control.

The disc tray automatically closes and the first track of the CD starts playing.

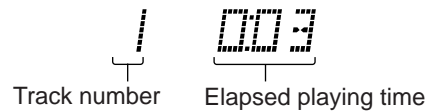

- The CD automatically stops when the last track of the CD has finished playing.

To stop playing, press .

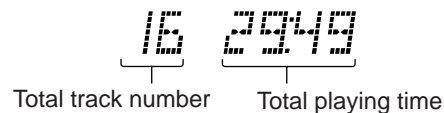

To remove the disc, press CD  on the remote control (or  on the CD player section).



- **If the CD cannot be read correctly (because it is scratched, for example)**
"00 0000" appears on the display.
- **If no CD is inserted**
"NO DISC" appears on the display.
- **If an unreadable CD-R or CD-RW is inserted**
"BLANK CD" appears on the display.



DO NOT try to open or close the CD tray by hand as it will be damaged.

Basic CD Operations

While playing a CD, you can do the following operations.

To stop playing for a moment





Press CD .





While pausing, the elapsed playing time flashes on the display.



To resume playing, press CD  again.



To go to another track

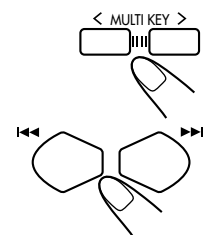

Press MULTI KEY  / MULTI KEY  or  /  repeatedly before or during playback.

- MULTI KEY  or  :
Skips to the beginning of the next or succeeding tracks.
- MULTI KEY  or  :
Goes back to the beginning of the current or previous tracks.



To locate a particular point in a track

During play, press and hold  or .

-  : Fast-forwards the tracks.
-  : Fast-reverses the tracks.

Programming the Playing Order of the Tracks — Program Play

You can arrange the order in which tracks play before you start playing. **You can program up to 20 tracks.**

1 Load a CD.

- If the current playing source is not the CD player, press CD ►/II, then ■ before going to the next step.

2 Press PROG (program).

The PRGM (program) indicator lights up on the display.

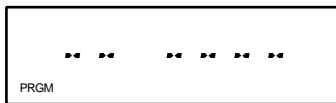

- If a program has been stored in memory, the program is called up.

3 Press MULTI KEY > or MULTI KEY < to select the track number, then press SET.

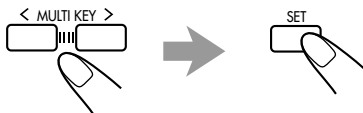

Track number Program step number

4 Repeat step 3 to program other tracks you want.

5 Press CD ►/II.

The tracks are played in the order you have programmed.



To stop playing, press ■.

To exit from Program play mode, press ■ before or after playing. The PRGM (program) indicator goes off. All the programmed tracks will be cleared.

- Disc ejection also erases the program.

To check the program contents

You can check the program contents by pressing PROG on the remote control. The programmed tracks are shown in the programmed order.

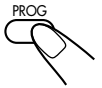

To modify the program

Before or after playing, you can erase the last programmed track by pressing CANCEL on the remote control.

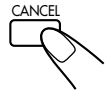

- Each time you press the button, the last programmed track is erased from the program.

To add tracks in the program before playing, simply select the track numbers you want to add by following step 3 of the programming procedure.



- **If you try to program the 21st track** “FULL” will appear on the display.
- **If the total playing time is 100 minutes or more** The total playing time will not be shown. “--:--” will appear.



Playing at Random — Random Play

The tracks will play in no particular order when you use this mode.

On the remote control ONLY:

To use **Random play mode**, press **RANDOM** before or during playing.
The **RANDOM** indicator lights up on the display.



The tracks are played at random.
Random play ends when all the tracks are played once.

To **skip the current track**, press **▶▶|** or **MULTI KEY >**.
• You cannot go back to the previous track by pressing **◀◀** or **MULTI KEY <**.

To **stop playing**, press **■**.
• Random play mode is also canceled.

To **exit from Random play mode**, press **RANDOM** again before or during playing. Random play mode is canceled and Normal play resumes.

Repeating Tracks — Repeat Play

You can have all the tracks, the program or individual track currently playing to repeat as many times as you like.

On the remote control ONLY:

To **repeat playing**, press **REPEAT** before or during playing.
• Each time you press the button, Repeat play mode changes as follows, and the following indicator lights up on the display:

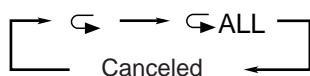

- : Repeats one track.
- : In Normal play mode, repeat all the tracks.
In Program play mode, repeat all the tracks in the program.
In Random play mode, repeats all the tracks in random order.

To **stop playing**, press **■**.

To **cancel Repeat play**, press **REPEAT** repeatedly until the repeat indicator goes off from the display.

- In Random play cannot be selected. If is selected when you press **RANDOM**, it is canceled (goes off).
- Repeat mode remains in effect even when you change the play mode.

Prohibiting Disc Ejection — Tray Lock

You can lock the disc tray and prohibit to eject the CD.
• This is possible only while the unit is turned on.

On the unit ONLY:

To **prohibit disc ejection**, press **⏻/I** (STANDBY/ON) while holding **■**. (If the disc tray is opened, close it first.)
“**LOCKED**” appears for a while, and the disc tray is locked.

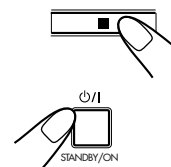

LOCKED

To **cancel the prohibition and unlock the CD**, press **⏻/I** (STANDBY/ON) while holding **■**.
“**UNLOCKED**” appears for a while, and the disc tray is unlocked.

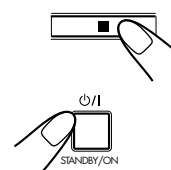

UNLOCKED



If you try to eject the CD,
“**LOCKED**” appears to inform you that the disc tray is locked.

Playing Back Tapes



You can play back type I, type II, and type IV tapes without changing any settings.

Playing Back a Tape

1 Press ▲ for cassette deck.

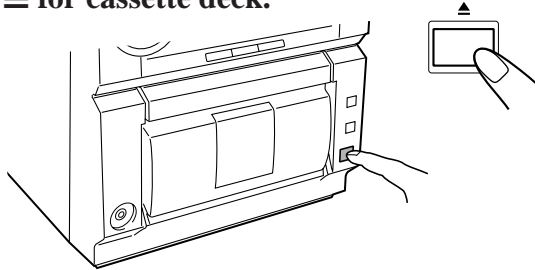

2 Put a cassette in with the exposed part of the tape down.

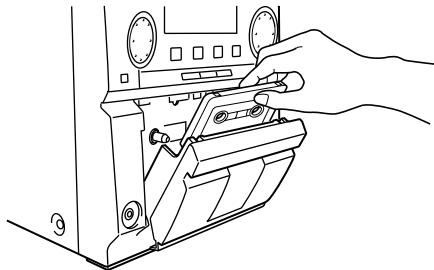

3 Close the cassette holder gently.

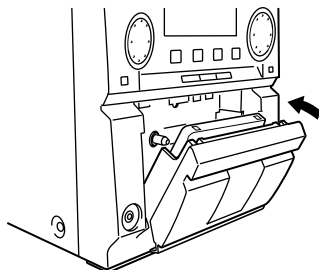

4 Press TAPE ◀▶.

The unit automatically turns on and the tape play starts. The tape direction indicator (▶ or ◀) flashes slowly on the display.

• Each time you press the button, the tape direction changes.

- ▶ : plays the front side.
- ◀ : plays the reverse side.



The tape direction lamp on the unit starts flashing to indicate the tape running direction.



When the tape plays to the end, the deck automatically stops if the reverse mode is set to ↔ or ↔. (See “To play both sides — Reverse Mode.”)

To stop playing, press ■.

To fast-wind to the left or to the right, press ▶▶ or ◀◀ while the tape is not running.

The tape direction indicator (▶ or ◀) starts flashing quickly on the display.

To remove the cassette, press ▲ for cassette deck.

To play both sides — Reverse Mode

You can set the deck to play just one side of a tape, both sides once, or both sides continuously.

Press **REV.MODE** on the unit.

• Each time you press the button, reverse mode changes as follows:

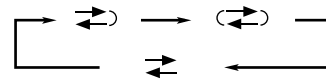

- ▶ : The deck automatically stops after playing both sides of the tape. (Stops when playback in the ◀ direction is finished.)
- ↔ : The deck continues to play both sides of the tape until ■ is pressed.
- ↔ : The deck automatically stops after playing one side of the tape.



The use of the C-120 or thinner tape is not recommended, since characteristic deterioration may occur and this tape easily jams in the pinch-rollers and the capstans.

IMPORTANT:

- It should be noted that it may be unlawful to re-record pre-recorded tapes, records, or discs without the consent of the owner of copyright in the sound or video recording, broadcast or cable programme and in any literary, dramatic, musical, or artistic embodied therein.
- The recording level is automatically set correctly, so it is not affected by the VOLUME, AHB (Active Hyper Bass) PRO, and SOUND MODE settings. Thus, during recording you can adjust the sound you are actually listening to without affecting the recording level.
- If recordings you have made have excessive noise or static, the unit may be too close to a TV. Increase the distance between the TV and the unit.
- You can use type I tape for recording.

To protect your recording

Cassettes have two small tabs on the back to protect from unexpected erasure or re-recording.

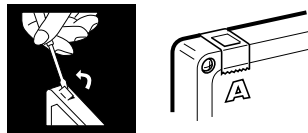

To protect your recording, remove these tabs.

To re-record on a protected tape, cover the holes with adhesive tape.

To keep the best recording and playback sound quality

If the heads, capstans, and pinch rollers of the cassette decks become dirty, the following will occur:

- Impaired sound quality
- Discontinuous sound
- Fading
- Incomplete erasure
- Difficulty in recording

To clean the heads, capstans, and pinch rollers

Use a cotton swab moistened with alcohol.

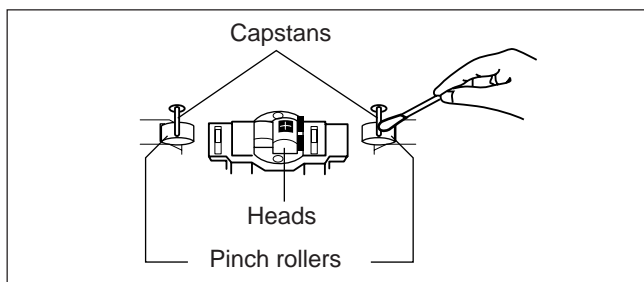

To demagnetize the heads

Turn off the unit, and use a head demagnetizer (available at electronics and audio shops).



At the start and end of cassette tapes

There is leader tape which cannot be recorded onto. Thus, when recording CDs or radio broadcasts, wind the leader tape first to ensure that the recording will be made without any music part lost.

Recording on a Tape

On the unit ONLY:

- 1 Put a recordable cassette in with the exposed part of the tape down.

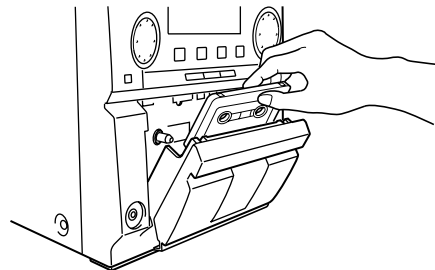

- 2 Close the cassette holder gently.

- If you want to record on both sides of a tape, see “To record on both sides — Reverse Mode.”

- 3 Check the recording direction for the tape.

- If the tape direction is not correct, press TAPE ◀▶ twice then ■ to change the tape direction.

- 4 Start playing the source — FM, AM or auxiliary equipment connected to AUX jacks.

- When the source is CD, see “CD Direct Recording” on page 19.

- 5 Press REC.

The REC indicator lights up on the display and recording starts.



The REC lamp on the unit also lights red.



To stop recording, press ■.

To remove the cassette, press ▲ for cassette deck.

To record on both sides — Reverse Mode

Press REV.MODE on the unit until the ↔ indicator is lit.



- When using the reverse mode for recording, start recording in the forward (▶) direction first. Otherwise, recording will stop when recording is done only on one side (reverse) of the tape.



CD Direct Recording

Everything on the CD goes onto the tape in the order it is on the CD, or according to the order you have made for Program play.

On the unit ONLY:

- 1 Put a recordable cassette in with the exposed part of the tape down.

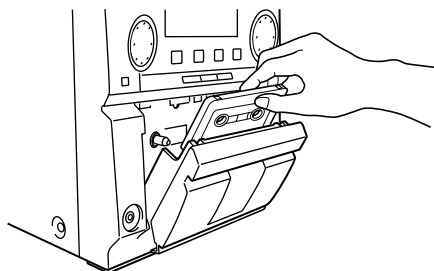

- 2 Place a disc correctly on the circle of the disc tray, with its label side up.

- If the current playing source is not the CD player, press CD ►/||, then ■ before going to the next step.
- If you want to record on both sides of a tape, see “To record on both sides — Reverse Mode.”
- If you do not want pauses of about 4 seconds recorded between selections, press CD ►/|| twice. If nothing is done, non-recorded pause will be automatically recorded between selections.

- 3 Press REC.

The REC indicator lights up on the display and recording starts.

After recording, the CD player and cassette deck automatically stop.



To stop CD Direct Recording, press ■. The tape stops after 4 seconds.

To remove the cassette, press ▲ for the cassette deck.

To record on both sides — Reverse Mode

Press REV.MODE on the unit until the ⇄ indicator is lit.



- When using the reverse mode for CD Direct Recording, start recording in the forward (►) direction first. When the tape reaches its end while recording a song in the forward direction (►), the last song will be re-recorded at the beginning of the reverse side (◄).

If you start recording on the reverse side (◄), recording will stop when recording is done only on one side (reverse) of the tape.



When making SLEEP timer settings while doing CD Direct recording

Set enough time to allow for the CD to finish playing; otherwise the power will go off before recording is completed.

One Track Recording

This recording method is convenient when you record tracks while playing a CD. You can only record your favorite songs on the tape.

On the unit ONLY:

- 1 Put a recordable cassette in with the exposed part of the tape down.

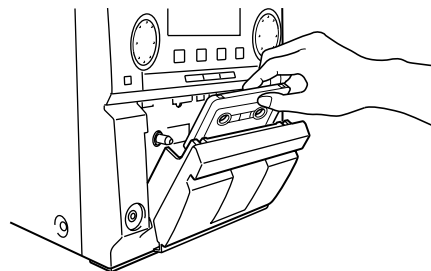

- 2 Play the track on the CD you wish to record.

- 3 Press REC.

The CD player returns to the beginning of that track and the track is recorded on the tape.

After recording, the CD player and cassette deck automatically stop.



- 4 Repeat steps 2 and 3 to record other tracks you want.

There are three timers available — Daily Timer, Recording Timer and Sleep Timer.

Before using the timers, you need to set the clock built in the unit (see page 9). When you press **TIMER** on the unit for more than 3 seconds, the display alternates between “ADJUST” and “CLOCK” for about 5 seconds.

Using Daily Timer and Recording Timer

You can set the timer whether the unit is on or off.

When the on-time comes, the unit automatically turns on (the  indicator flashes just before the on-time, and continues flashing while the timer is operating). Then, when the off-time comes, the unit automatically turns off (on standby). The timer setting remains in memory until you change it.

- When the **DAILY** indicator is lit on the display, the timer acts as the Daily Timer. Once the Daily Timer has been set, it will be activated at the same time everyday until the timer is turned off.
- When the **REC** indicator is lit on the display, the timer acts as the Recording Timer. After the Recording Timer has been performed, the details of the setting remain stored but the timer is turned off.

Before you start...

When using “TUNER” as the source to play, make sure to select the desired station before turning off the power.

- There is a time limit in doing the following steps. If the setting is canceled before you finish, start from step 1 again.

On the unit ONLY:

1 Press and hold **TIMER** for more than 3 seconds.

The timer () indicator lights up, and the timer mode indicator (**DAILY** or **REC**) and the current on-time flash on the display. The unit enters on-time setting mode.



2 Set the on-time you want the unit to turn on at.

- 1) Press **▶▶|** or **|◀◀** to set the hour, then press **TIMER**.
 - 2) Press **▶▶|** or **|◀◀** to set the minute, then press **TIMER**.
- The unit enters off-time setting mode.

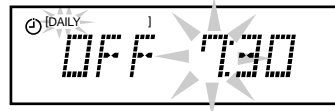
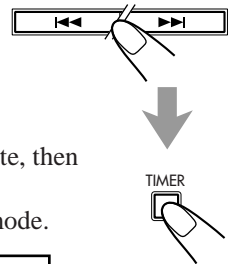

3 Set the off-time you want the unit to turn off (on standby) at.

- 1) Press **▶▶|** or **|◀◀** to set the hour, then press **TIMER**.
 - 2) Press **▶▶|** or **|◀◀** to set the minute, then press **TIMER**.
- The unit enters source selecting mode.

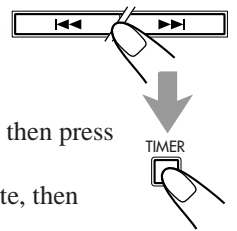

4 Press **▶▶|** or **|◀◀** to select the timer mode (Daily Timer or Recording Timer) and the source to play, then press **TIMER**.

- Each time you press **▶▶|** or **|◀◀**, the timer mode and the source change as follows:

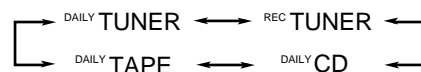

DAILY TUNER: tunes into the last station you were listening to. (Daily Timer)

REC TUNER: records the last station you were listening to. (Recording Timer)

- Put a recordable cassette into the deck.

DAILY CD: plays a CD. (Daily Timer)

DAILY TAPE: plays a tape. (Daily Timer)

- Make sure that the tape direction is correct.

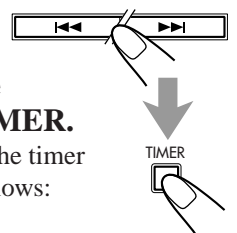

5 Press **▶▶|** or **|◀◀** to set the volume level.

- You can select the volume level (“VOLUME 0” to “VOLUME40” and “VOLUME –”). If you select “VOLUME –,” the volume is set to the last level when the unit has been turned off.



To turn off the volume while the Recording Timer (REC TUNER) is working, set the volume level “VOLUME 0.”



6 Press **TIMER** to complete the timer setting.



7 Press **⏻/I** (**STANDBY/ON**) to turn off the unit (on standby) if you have set the timer with the unit turned on.

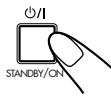

- When the timer turns on the unit, the timer (⌚) indicator and the selected timer mode indicator (**DAILY** or **REC**) start flashing.

To cancel the setting, press and hold **TIMER** until the timer (⌚) indicator goes off from the display.



- **If the unit is turned on when the timer-on time comes**
Timer does not work.
- **When you unplug the AC power cord or if a power failure occurs**
The timer will be canceled. You need to set the clock first, then the timer again.

Using Sleep Timer

With Sleep Timer, you can fall asleep to music. You can set Sleep Timer when the unit is turned on.

How Sleep Timer actually works

The unit automatically turns off after the specified time length passes.

On the remote control **ONLY**:

1 Press **SLEEP**.

The time length until the shut-off time appears and the **SLEEP** indicator lights up on the display.



- Each time you press the button, the time length changes as follows:

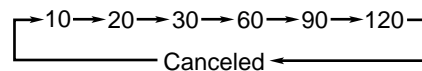

2 Wait for about 5 seconds after specifying the time length.

To check the remaining time until the shut-off time, press **SLEEP** once so that the remaining time until the shut-off time appears for about 5 seconds.

To change the shut-off time, press **SLEEP** repeatedly until the desired time length appears on the display.

To cancel the setting, press **SLEEP** repeatedly until the **SLEEP** indicator goes off.

- Sleep Timer is also canceled when you turn off the unit.



- **If you set the Sleep Timer after Daily Timer starts playing the selected source**
Daily Timer is canceled.
- **If you set the Sleep Timer after Recording Timer starts recording**
Recording Timer is canceled, but recording continues until Sleep Timer shuts off the power.

Additional Information



Description of the PTY codes:

NEWS:	News.
AFFAIRS:	Topical program expanding or enlarging upon the news — debate, or analysis.
INFO:	Program the purpose of which is to impart advice in the widest sense.
SPORT:	Program concerned with any aspect of sports.
EDUCATE:	Educational programs.
DRAMA:	All radio plays and serials.
CULTURE:	Programs concerning any aspect of national or regional culture, including language, theater, etc.
SCIENCE:	Programs about natural sciences and technology.
VARIED:	Used for mainly speech-based programs such as quizzes, panel games and personality interviews.
POP M:	Commercial music of current popular appeal.
ROCK M:	Rock music.
EASY M:	Current contemporary music considered to be “easy-listening.”
LIGHT M:	Instrumental music, and vocal or choral works.
CLASSICS:	Performances of major orchestral works, symphonies, chamber music, etc.
OTHER M:	Music not fitting into any of the other categories.
WEATHER:	Weather reports and forecasts.
FINANCE:	Stock Market reports, commerce, trading etc.

CHILDREN:	Programs targeted at a young audience.
SOCIAL:	Programs about sociology, history, geography, psychology and society.
RELIGION:	Religious programs.
PHONE IN:	Involving members of the public expressing their views either by phone or at a public forum.
TRAVEL:	Travel information.
LEISURE:	Programs about recreational activities.
JAZZ:	Jazz music.
COUNTRY:	Songs which originate from, or continue the musical tradition of the American Southern States.
NATION M:	Current popular music of the nation or region in that country’s language.
OLDIES:	Music from the so-called “golden age” of popular music.
FOLK M:	Music which has its roots in the musical culture of a particular nation.
DOCUMENT:	Program concerning factual matters, presented in an investigative style.
TRAFFIC:	Traffic announcement.

Classification of the PTY codes for some FM stations may be different from the above list.

Troubleshooting



If you are having a problem with your unit, check this list for a possible solution before calling for service.

If you cannot solve the problem from the hints given here, or the unit has been physically damaged, call a qualified person, such as your dealer, for service.

Symptom	Cause	Action
No sound is heard.	<ul style="list-style-type: none"> • Connections are incorrect or loose. • Headphones are connected. 	<ul style="list-style-type: none"> • Check all connections and make corrections. (See pages 6 to 8.) • Disconnect the headphones.
Hard to listen to broadcasts because of noise.	<ul style="list-style-type: none"> • Antennas are disconnected. • The AM loop antenna is too close to the unit. • The FM antenna is not properly extended and positioned. 	<ul style="list-style-type: none"> • Reconnect the antennas correctly and securely. • Change the position and direction of the AM loop antenna. • Extend the FM antenna at the best position.
The disc tray does not open or close.	The AC power cord is not plugged in.	Plug the AC power cord.
The disc does not play.	The disc is placed upside down.	Place the disc with the label side up.
The disc sound is discontinuous.	The disc is scratched or dirty.	Clean or replace the disc. (See page 23.)
The cassette holder cannot be opened.	Power supply from the AC power cord has been cut off while the tape was running.	Turn on the unit.
Impossible to record.	Small tabs on the back of the cassette are removed.	Cover the holes with adhesive tape.
Operations are disabled.	The built-in microprocessor may malfunction due to external electrical interference.	Unplug the AC power cord and then plug it back in.
Unable to operate the unit from the remote control.	<ul style="list-style-type: none"> • The path between the remote control and the remote sensor on the unit is blocked. • The batteries are exhausted. 	<ul style="list-style-type: none"> • Remove the obstruction. • Replace the batteries.

Maintenance



To get the best performance of the unit, keep your discs, tapes, and mechanism clean.

Handling discs



- Remove the disc from its case by holding it at the edge while pressing the center hole lightly.
- Do not touch the shiny surface of the disc, or bend the disc.
- Put the disc back in its case after use to prevent warping.

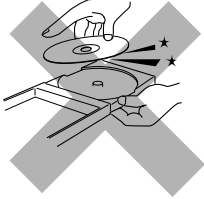

- Be careful not to scratch the surface of the disc when placing it back in its case.
- Avoid exposure to direct sunlight, temperature extremes, and moisture.



To clean the disc

Wipe the disc with a soft cloth in a straight line from center to edge.



DO NOT use any solvent — such as conventional record cleaner, spray, thinner, or benzine — to clean the disc.

Cleaning the unit

Stains on the unit

Should be wiped off with a soft cloth. If the unit is heavily stained, wipe it with a cloth soaked in water-diluted neutral detergent and wrung well, then wipe clean with a dry cloth.

Since the unit may deteriorate in quality, become damaged or get its paint peeled off, be careful about the followings.

- DO NOT wipe it with a hard cloth.
- DO NOT wipe it strong.
- DO NOT wipe it with thinner or benzine.
- DO NOT apply any volatile substance such as insecticides to it.
- DO NOT allow any rubber or plastic to remain in contact with it for a long time.

Handling cassette tapes

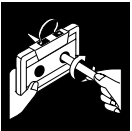

- If the tape is loose in its cassette, take up the slack by inserting a pencil in one of the reels and rotating.
- If the tape is loose, it may get stretched, cut, or caught in the cassette.



- Be careful not to touch the tape surface.



- Avoid the following places to store the tape:
 - In dusty places
 - In direct sunlight or heat
 - In moist areas
 - On a TV or speaker
 - Near a magnet

Specifications

Design and specifications are subject to change without notice.

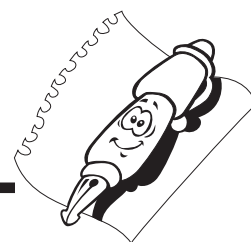

UX-P7R (CA-UXP7R and SP-UXP7)

Amplifier

Output Power

SUBWOOFERS:

110 W (55 W + 55 W) at 6 Ω (MAX.)

70 W (35 W + 35 W) at 6 Ω (10 % THD)

MAIN SPEAKERS:

36 W (18 W + 18 W) at 6 Ω (MAX.)

30 W (15 W + 15 W) at 6 Ω (10 % THD)

Audio input sensitivity/Impedance (at 1 kHz)

AUX: 400 mV/48 kΩ

Audio output level

AUX: 260 mV/5.8 kΩ

Digital output — OPTICAL DIGITAL OUT

Signal wave length: 660 nm

Output level: -21 dBm to -15 dBm

Speakers/Impedance 6 Ω – 16 Ω

Tuner

FM tuning range 87.50 MHz – 108.00 MHz

AM tuning range

MW: 522 kHz – 1 629 kHz

LW: 144 kHz – 288 kHz

CD player

Dynamic range 85 dB

Signal-to-noise ratio 90 dB

Wow and flutter Immeasurable

Cassette deck

Frequency response

Normal (type I): 50 Hz – 14 000 Hz

Wow and flutter 0.15 % (WRMS)

General

Power requirement AC 230 V \sim , 50 Hz

Power consumption 90 W (at operation)

1.2 W (on standby)

Dimensions (approx.) 525 mm x 305 mm x 249 mm (W/H/D)
(20 ⁷/₈ in. x 12 ¹/₁₆ in. x 9 ⁷/₁₆ in.)

Mass (approx.) 12.7 kg (28.1 lbs)

Supplied Accessories

See page 6.

Speaker

Speaker units Subwoofer 13.5 cm (5 ³/₈ in.) cone x 1

Woofer 8.0 cm (3 ³/₁₆ in.) cone x 1

Tweeter 2.0 cm (¹³/₁₆ in.) cone x 1

Impedance

Subwoofer: 6 Ω

Main speaker: 6 Ω

Dimensions (approx.) 170 mm x 305 mm x 253 mm (W/H/D)
(6 ³/₄ in. x 12 ¹/₁₆ in. x 10 in.)

Mass (approx.) 3.5 kg (7.8 lbs)

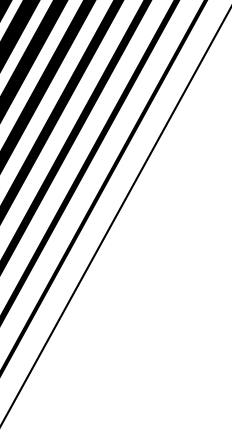

JVC
VICTOR COMPANY OF JAPAN, LIMITED